

Digital Cinema Camera

# EOS C500

# EOS C500 PL

Instruction Manual

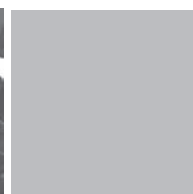

# Important Usage Instructions

2

**WARNING**

TO REDUCE THE RISK OF FIRE OR ELECTRIC SHOCK, DO NOT EXPOSE THIS PRODUCT TO RAIN OR MOISTURE.

**WARNING**

TO REDUCE THE RISK OF ELECTRIC SHOCK, DO NOT EXPOSE THIS PRODUCT TO DRIPPING OR SPLASHING.

**WARNING**

TO REDUCE THE RISK OF ELECTRIC SHOCK AND TO REDUCE ANNOYING INTERFERENCE, USE THE RECOMMENDED ACCESSORIES ONLY.

**COPYRIGHT WARNING:**

Unauthorized recording of copyrighted materials may infringe on the rights of copyright owners and be contrary to copyright laws.

The Mains plug is used as the disconnect device. The Mains plug shall remain readily operable to disconnect the plug in case of an accident.

**CAUTION:**

- Danger of explosion if the wrong type of batteries are attached. Use only the same type of batteries.
- Do not expose batteries or product to excessive heat such as the inside of a car under direct sunlight, fire, etc.

EOS C500 / EOS C500 PL / CA-941 / CG-940 identification plate is located on the bottom.



**CAUTION:**  
TO REDUCE THE RISK OF ELECTRIC SHOCK, DO NOT REMOVE COVER (OR BACK). NO USER-SERVICEABLE PARTS INSIDE. REFER SERVICING TO QUALIFIED SERVICE PERSONNEL.



The lightning flash with arrowhead symbol, within an equilateral triangle, is intended to alert the user to the presence of uninsulated “dangerous voltage” within the product’s enclosure, that may be of sufficient magnitude to constitute a risk of electric shock to persons.



The exclamation point, within an equilateral triangle, is intended to alert the user to the presence of important operating and maintenance (servicing) instructions in the literature accompanying the product.

**Only for European Union and EEA (Norway, Iceland and Liechtenstein)**



These symbols indicate that this product is not to be disposed of with your household waste, according to the WEEE Directive (2012/19/EU), the Battery Directive (2006/66/EC) and/or national legislation implementing those Directives.

■ If a chemical symbol is printed beneath the symbol shown above, in accordance with the Battery Directive, this indicates that a heavy metal (Hg = Mercury, Cd = Cadmium, Pb = Lead) is present in this battery or accumulator at a concentration above an applicable threshold specified in the Battery Directive.

This product should be handed over to a designated collection point, e.g., on an authorized one-for-one basis when you buy a new similar product or to an authorized collection site for recycling waste electrical and electronic equipment (EEE) and batteries and accumulators. Improper handling of this type of waste could have a possible impact on the environment and human health due to potentially hazardous substances that are generally associated with EEE. Your cooperation in the correct disposal of this product will contribute to the effective usage of natural resources.

For more information about the recycling of this product, please contact your local city office, waste authority, approved scheme or your household waste disposal service or visit [www.canon-europe.com/weee](http://www.canon-europe.com/weee), or [www.canon-europe.com/battery](http://www.canon-europe.com/battery).

COPY

# Important Safety Instructions

4

In these safety instructions the word “apparatus” refers to the Canon Digital Cinema Camera EOS C500 / EOS C500 PL and all its accessories.

1. Read these instructions.
2. Keep these instructions.
3. Heed all warnings.
4. Follow all instructions.
5. Do not use this apparatus near water.
6. Clean only with dry cloth.
7. Do not block any ventilation openings. Install in accordance with the manufacturer’s instructions.
8. Do not install near any heat sources such as radiators, heat registers, stoves, or other apparatus (including amplifiers) that produce heat.
9. Do not defeat the safety purpose of the polarized or grounding-type plug. A polarized plug has two blades with one wider than the other.

A grounding type plug has two blades and a third grounding prong. The wide blade or the third prong are provided for your safety. If the provided plug does not fit into your outlet, consult an electrician for replacement of the obsolete outlet.

10. Protect the power cord from being walked on or pinched particularly at plugs, convenience receptacles, and the point where they exit from the apparatus.
11. Only use attachments/accessories specified by the manufacturer.
12. Unplug this apparatus during lightning storms or when unused for long periods of time.
13. Refer all servicing to qualified service personnel. Servicing is required when the apparatus has been damaged in any way, such as power-supply cord or plug is damaged, liquid has been spilled or objects have fallen into the apparatus, the apparatus has been exposed to rain or moisture, does not operate normally, or has been dropped.

## Trademark Acknowledgements

- SD and SDHC Logos are trademarks of SD-3C, LLC.
- CompactFlash is a trademark of SanDisk Corporation.
- The CF Logo is a trademark of CompactFlash Association.
- Microsoft and Windows are trademarks or registered trademarks of Microsoft Corporation in the United States and/or other countries.
- Apple, iMac, Mac OS, Macbook, Macbook Air, Final Cut Pro are trademarks of Apple Inc., registered in the U.S. and other countries.
- Avid, Media Composer and NewsCutter are trademarks or registered trademarks of Avid Technology, Inc. or its subsidiaries in the United States and/or other countries.
- Wi-Fi is a registered trademark of the Wi-Fi Alliance.
- AJA, KONA 3G-SDI are trademarks of AJA Video, Inc. All other trademarks are the property of their respective holders.
- NVIDIA, CUDA, GeForce and Quadro are trademarks and/or registered trademarks of NVIDIA Corporation in the U.S. and other countries.
- HDMI, the HDMI logo and High-Definition Multimedia Interface are trademarks or registered trademarks of HDMI Licensing LLC in the United States and other countries.
- Other names and products not mentioned above may be trademarks or registered trademarks of their respective companies.
- This device incorporates exFAT technology licensed from Microsoft.
- ANY USE OF THIS PRODUCT OTHER THAN CONSUMER PERSONAL USE IN ANY MANNER THAT COMPLIES WITH THE MPEG-2 STANDARD FOR ENCODING VIDEO INFORMATION FOR PACKAGED MEDIA IS EXPRESSLY PROHIBITED WITHOUT A LICENSE UNDER APPLICABLE PATENTS IN THE MPEG-2 PATENT PORTFOLIO, WHICH LICENSE IS AVAILABLE FROM MPEG LA, L.L.C., 250 STEELE STREET, SUITE 300, DENVER, COLORADO 80206.

# Highlights of the EOS C500/C500 PL

The Canon Digital Cinema Camera EOS C500/C500 PL has been designed with the discerning professional in mind. It is truly a cinematographer's camera. The following are just some of the many features that will help turn your creative vision into reality.

## 4K Recording System with Cinema Quality

### Advanced 4K-compatible Super 35mm CMOS sensor

The camera is equipped with a Super 35mm CMOS sensor that captures video at an effective pixel count of 8.85 megapixels (4096x2160) and offers a center resolution of 1,800 TV lines<sup>1</sup>. Furthermore, thanks to Canon's high-sensitivity and low-noise technology, the camera can record at an ISO level of 20,000<sup>2</sup> - a level of sensitivity that must be seen to be believed!

<sup>1</sup> Varies depending on the lens used.

<sup>2</sup> You can extend the ISO level to 80,000.

### Interchangeable lenses

Enjoy the freedom of using interchangeable lenses to achieve exactly the look you want. The EOS C500 features an EF lens mount allowing you to use over 60 high-quality lenses from the Canon Cine Lens series and EF Lens series. The EOS C500 PL features a PL lens mount, allowing you to use a vast array of cinematography lenses compatible with a Canon PL lens mount and other lenses commonly used in motion picture production.

### 4K, 2K and MXF modes

In 4K and 2K modes, the camera outputs image data for recording with an external recorder. In 4K mode, the camera outputs Canon RAW image data, which is free of compression noise. In 2K mode, the camera outputs up to an RGB 4:4:4 12-bit signal. In MXF mode, the camera records HD audio and video to CompactFlash (CF) cards. HD recordings are saved as Material eXchange Format (MXF) files and are compatible with major non-linear editing (NLE) software. For example, you can use these MXF files as proxy video for your NLE software. Furthermore, even in 4K and 2K modes, the camera can record MXF files on a CF card.

### Multitude of recording options

The camera offers you numerous options when it comes to the video configuration of your recordings. When recording in 4K or 2K mode, you can select the recording mode (RAW, HRAW, 4K1K RAW, RGB 4:4:4 12-bit, RGB 4:4:4 10-bit or YCC 4:2:2 10-bit), system frequency (59.94 Hz, 50.00 Hz, 24.00 Hz), resolution (various settings from 1920x1080 to 4096x2160) and frame rate (various settings from 23.98P up to 59.94P). This allows you to select a video configuration to suit your needs from a total of

46 different combinations. When recording in MXF mode, you can select the system frequency, bit rate, resolution and frame rate of your recordings. These options allow you to choose from a total of 27 different combinations.

### Recording media

Because there are two CF card slots, when one CF card slot becomes full, the recording will automatically continue on the other one without interruption when you use relay recording (📖 46). In addition, using double slot recording (📖 46) lets you record the same clip simultaneously to both CF cards.

### 3G-SDI and MON. terminals

The camera features dual 3G-SDI terminals (📖 41) that can output 4K or 2K image data to an external recorder. The dual MON. terminals (📖 41) are HD-SDI terminals that can output YCC 4:2:2 10-bit 2K or full HD video, allowing external live monitoring during shoots. You can even apply a LUT and use it for on-set color grading (📖 22). Of course, both sets of terminals also output audio, SMPTE time code (LTC) and user bit signals. In addition, you can output the signal from the 3G-SDI terminal with an extended color space (📖 142).

### Canon Log gamma for spectacular dynamic range

The Canon Log gamma (📖 58) makes full use of the sensor to give your recordings amazing dynamic range. In 4K and 2K modes, the camera will always use Canon Log gamma. In MXF mode, you may want to use CINEMA preset (📖 58) to set the camera easily and quickly for shooting with Canon Log gamma.

## Operability and Adaptability

### Freely customizable compact design

The modular components, including the supplied handle unit and monitor unit will let you expand and adapt the configuration to match your shooting conditions (📖 32). The articulated monitor unit can be rotated 270° for maximum convenience. The 10.1-cm (4-in.) LCD screen with 100% coverage ensures that you can compose your shots with ease.

### Pro-level connectivity

In addition to the 3G-SDI terminals mentioned previously, the HD/SD SDI terminal can output YCC 4:2:2 10-bit (8-bit effective) HD/SD video as well as audio and time code signals. Genlock synchronization (☞ 88), the TIME CODE terminal (☞ 89, 91) and SYNC OUT terminal allow the camera to be part of any multi-camera shooting setup.

### Customization

The camera features several customization options. You can assign often-used functions to assignable buttons (☞ 111) so that you can call up those functions with the press of a single button. You can also register frequently-used menu settings in an easy-to-access personal menu (My Menu, ☞ 30). Custom functions (☞ 122) and custom onscreen displays (☞ 123) give you even more freedom to control many aspects of the camera's operation. During MXF mode, with custom picture settings (☞ 114), you can enjoy unparalleled image control to deliver the "look" you want by adjusting parameters, such as gamma and sharpness. The custom picture settings can be recorded onto an SD card, which allows multiple C500 / C500 PL cameras to use the same settings, or embedded in the recording itself (☞ 116, 134, 166).

### Remote operation via Wi-Fi

You can attach the optional WFT-E6 Wireless File Transmitter to the camera and operate it remotely via Wi-Fi using the Wi-Fi Remote application (☞ 49). The Wi-Fi Remote application lets you monitor the image through live view and remotely control the focus, shutter speed, ISO speed/gain and other settings.

## Other Features

### Special recording modes

The special recording modes (☞ 105) give you more creative control over your recordings. You can create a slow motion or fast motion effect in your recordings, record a certain number of frames at a set interval (ideal for nature shots and other subjects with little movement) or record a certain number of frames every time you press a button (ideal for stop motion animation).

### Software for aiding the production workflow

The **Cinema RAW Development** software, which can be downloaded from your local Canon Web site, can develop the 4K RAW data recorded with an external recorder and export it as a standard file type such as DPX. This helps make a smooth transition to the color grading process.

### Audio

Sound is recorded as 2-channel linear PCM audio (16-bit/48 kHz). You can use the MIC terminal for microphones with a Ø 3.5 mm mini-stereo plug or the two XLR audio input terminals (with phantom power supply) when recording.

### Video scopes

Check the brightness of the image using the waveform monitor (☞ 100), the color of the image using the vectorscope (☞ 101), or the focus using the edge monitor (☞ 101).

# Table of Contents

## 1. Introduction 11

- About this Manual 11
  - Conventions Used in this Manual 11
- Supplied Accessories 13
- Names of Parts 14
  - Monitor Unit 19
  - Handle Unit 19
- 4K Workflow Overview 21
  - Color Grading with the ACES Workflow 22

## 2. Preparations 23

- Preparing the Power Supply 23
  - Using a Battery Pack 23
  - Using a Household Power Outlet 25
  - Turning the Camera On and Off 26
- Date, Time and Language Settings 27
  - Setting the Date and Time 27
  - Changing the Time Zone 27
  - Displaying the Date and Time while Recording 28
  - Changing the Language 28
- Using the Menus 29
  - Selecting an Option from the Menu 29
  - Using the Customized Submenu (My Menu) 30
- Preparing the Camera 32
  - Preparing the Lens 32
  - Attaching and Removing the Monitor Unit 35
  - Using the Viewfinder 36
  - Using the LCD Panel 37
  - Adjusting the Viewfinder/LCD Screen 38
  - Using a Tripod 38
  - Attaching the Handle Unit 39
  - Attaching a Shoulder Strap 39
  - Removing and Attaching the Terminal Covers 40
- Connecting to a 4K- or 2K-Compatible External Recorder 41

## Preparing Recording Media 43

- Inserting a CF Card 43
- Checking the Status of the CF Card Slots 43
- Removing a CF card 44
- Inserting and Removing an SD Card 44
- Initializing the Recording Media 45
- Switching Between the CF Card Slots 46
- Selecting the CF Card Recording Method 46
- Checking the Available Recording Time for CF Cards 47
- Recovering Data on the CF Card 47
- Adjusting the Black Balance 48
- Remote Operation Via the Wi-Fi Remote Application 49
  - Preparing the System for Wi-Fi Remote 49

## 3. Recording 51

- Recording Video 51
  - Preparing to Record 51
  - Recording 51
  - Remote Operation Using Wi-Fi Remote 54
  - Onscreen Displays 55
  - Rear Panel Displays 57
  - Canon Log Gamma and CINEMA Preset 58
  - Checking Clips Recorded with Canon Log Gamma (View Assistance) 58
  - Using the Internal Cooling Fan 59
- Video Configuration: Type of Recording, Resolution and Frame Rate 60
  - Selecting the Video Configuration for 4K and 2K Modes 60
  - Selecting the Video Configuration for MXF Mode 64
- Changing Main Camera Functions with the FUNC. Button 66
  - Using the Direct Setting Mode 66
- Shutter Speed 67
  - Changing the Shutter Speed Mode and Value 68
  - Remote Operation Using Wi-Fi Remote 68
- ISO Speed/Gain 70
  - Changing the ISO Speed or Gain Value 70
  - Using the Control Dial 71
  - Remote Operation Using Wi-Fi Remote 71

- ND Filter 73
    - Using the ND Filter 73
    - Remote Operation Using Wi-Fi Remote 73
  - C500** Adjusting the Aperture 74
    - Using the Control Dial 74
    - Remote Operation Using Wi-Fi Remote 75
  - White Balance 76
    - Setting the White Balance 76
    - Remote Operation Using Wi-Fi Remote 77
  - Adjusting the Focus 79
    - Adjusting the Focus Manually 79
    - C500** Remote Operation Using Wi-Fi Remote 79
    - Using the Focus Assistance Functions 80
  - Onscreen Markers and Zebra Patterns 82
    - Displaying Onscreen Markers 82
    - Displaying Zebra Patterns 83
  - Setting the Time Code 84
    - Selecting the Running Mode 84
    - Selecting Drop or Non-Drop Frame 85
    - Putting the Time Code Display on Hold 85
  - Setting the User Bit 87
  - Synchronizing with an External Device 88
    - Connecting an External Device 88
    - Reference Video Signal Input (Genlock Synchronization) 88
    - Time Code Signal Input 89
    - Reference Video Signal Output 90
    - Time Code Signal Output 91
  - Recording Audio 92
    - Connecting an External Microphone or External Audio Input Source to the Camera 92
    - Selecting the Audio Input from the XLR Terminals 93
    - Adjusting the Audio Level from the XLR Terminals 94
    - Adjusting the Audio Level from the MIC Terminal 95
    - Monitoring the Audio with Headphones 96
  - Using Metadata 97
    - Setting a User Memo Created with Canon XF Utility 97
    - Setting a User Memo Using Wi-Fi Remote 98
  - Color Bars/Audio Reference Signal 99
    - Recording Color Bars 99
    - Recording an Audio Reference Signal 99
  - Video Scopes 100
    - Displaying a Video Scope 100
    - Configuring the Waveform Monitor 100
    - Configuring the Vectorscope 101
    - Configuring the Edge Monitor 101
  - Adding Marks while Recording MXF Clips 102
    - Adding Shot Marks while Recording 102
    - Remote Operation Using Wi-Fi Remote 102
    - Adding an **OK** Mark or **✓** Mark to the Last Clip Recorded 103
    - Remote Operation Using Wi-Fi Remote 103
  - Reviewing an MXF Clip 104
  - Special Recording Modes 105
    - Interval Recording Mode 105
    - Frame Recording Mode 106
    - Slow & Fast Motion Mode 108
    - Pre-recording Mode 110
- ## 4. Customization 111
- Assignable Buttons 111
    - Changing the Assigned Function 111
    - Using an Assignable Button 112
  - Custom Picture Settings 114
    - Selecting Custom Picture Files 114
    - Editing a Custom Picture File's Settings 114
    - Renaming Custom Picture Files 115
    - Protecting Custom Picture Files 115
    - Transferring Custom Picture Files 115
    - Embedding Custom Picture Settings in a Recording 117
    - Available Custom Picture Settings 117
  - Customizing Functions and Onscreen Displays 122
    - Customizing Functions 122
    - Customizing Onscreen Displays 123
  - Saving and Loading Camera Settings 124
    - Saving Camera Settings to an SD Card 124
    - Loading Camera Settings from an SD Card 124



## 5. Playback 125

### Playing Back MXF Clips 125

- Clip Index Screen 125
- Playing Back Clips 126
- Onscreen Displays 127
- Playback Controls 128
- Audio Output 129

### MXF Clip Operations 130

- Using the Clip Menu 130
- Displaying Clip Information 131
- Adding  Marks or  Marks 132
- Deleting  Marks or  Marks 132
- Copying Clips 133
- Deleting Clips 134
- Deleting the User Memo 134
- Copying a Custom Picture File Embedded in a Clip 134
- Displaying an Index Screen of Shot Marks 135
- Displaying a Frame Index Screen of a Single Clip 136
- Adding Shot Marks 136
- Deleting Shot Marks 137
- Changing a Clip's Thumbnail 137

## 6. External Connections 139

### Video Output Configuration 139

- Video Configuration and Video Output Configuration for 4K and 2K Modes 139
- Video Output Configuration for MXF Mode 141

### Selecting the Color Space 142

### Connecting to an External Monitor 144

- Connection Diagram 144
- Using the MON. 1 and MON. 2 Terminals 145
- Video Output Using ACESproxy10 (for On-set Color Grading) 146
- Using the HD/SD SDI Terminal 147
- Using the HDMI OUT Terminal 147
- Using the SYNC OUT Terminal 148
- Selecting the Resizing Method for SD Video 148
- Superimposing Onscreen Displays to Appear on an External Monitor 149

### Developing RAW Clips 150

- System Requirements 150
- Installing and Uninstalling Cinema RAW Development (Windows) 150
- Installing and Uninstalling Cinema RAW Development (Mac OS) 151
- Viewing the Software Instruction Manual 151

### Saving MXF Clips to a Computer 153

- System Requirements 153
- Installing and Uninstalling Canon XF Utility (Windows) 154
- Installing and Uninstalling Canon XF Utility (Mac OS) 156
- Viewing the Software Instruction Manuals 159

## 7. Photos 161

### Taking Photos 161

- Taking Photos in CAMERA Mode 161
- Capturing Photos in MEDIA Mode 161

### Photo Playback 163

- Displaying the [Photos] Index Screen 163
- Viewing Photos 163

### Photo Operations 164

- Using the Photo Menu 164
- Deleting Photos 164
- Protecting Photos 165
- Copying Custom Picture Files 166
- Photo Numbering 167

## 8. Additional Information 169

### Menu Options 169

### Displaying the Status Screens 180

### Troubleshooting 187

- List of Messages 190

### Handling Precautions 194

### Maintenance/Others 197

### Optional Accessories 200

### Specifications 203

### Index 209

COPY

## About this Manual

Thank you for purchasing the Canon EOS C500/C500 PL. Please read this manual carefully before you use the camera and retain it for future reference. Should the camera fail to operate correctly, refer to *Troubleshooting* (📖 187).

### Conventions Used in this Manual

- **!** IMPORTANT: Precautions related to the camera's operation.
- **i** NOTES: Additional topics that complement the basic operating procedures.
- **📖**: Reference page number.
- **C500**: Text that applies only to the model shown in the icon.
- The following terms are used in this manual.
  - “Screen” refers to the LCD screen and the viewfinder screen.
  - “CF card” refers to a CompactFlash (CF) card.
  - “SD card” refers to an SD or SDHC memory card.
  - “Recording media” refers to CF cards and SD cards.
- Photographs in the manual are simulated pictures taken with a still camera. Some screenshots have been altered to make them easier to read.
- Illustrations in the manual show the Canon EOS C500 camera with a Canon EF 50mm f/1.4 USM lens attached.

The arrow is used to abbreviate menu selections. For a detailed explanation on how to use the menus, refer to *Using the Menus* (129). For a concise summary of all available menu options and settings, refer to the appendix *Menu Options* (169).

Operating modes

**CAMERA** indicates that a function is available in the operating mode (the two icons left of the dividing bar) and system priority (the three icons to the right of the dividing bar) indicated and **CAMERA** indicates that the function is not available. For a detailed explanation, refer to *Turning the Camera On and Off* (26) and *Selecting the System Priority* (60, 64).

84

**Setting the Time Code**

While recording, the camera can generate a time code signal and embed it in your recordings. You can have the camera output the time code signal from the 3G-SDI terminals, MON. terminals, HD/SD SDI terminal or TIME CODE terminal (91). In addition, you can superimpose the time code on video output from the HDMI OUT terminal or SYNC OUT terminal. While playing back video recorded on a CF card, you can output the time code on the CF card from the HD/SD SDI terminal or TIME CODE terminal. Additionally, you can superimpose the time code on the picture from the HDMI OUT terminal or SYNC OUT terminal. For recordings with a frame rate of 29.97P, 59.94i or 59.94P, you can also select between a drop frame and non-drop frame time code. To synchronize the camera's time code to an external time code generator, refer to *Synchronizing with an External Device* (88).

Operating modes: **CAMERA** **MEDIA** **4K** **2K** **MXF**

**Selecting the Running Mode**

During MXF mode, you can select the running mode of the camera's time code. During 4K and 2K modes, the running mode will be set to [Free Run] during normal shooting and slow & fast recording mode; it will be set to [Rec Run] during interval recording and frame recording modes. You can set the time code's initial value, however, by performing the procedure in the following section *Setting the Time Code's Initial Value*.

1 Open the time code [Mode] submenu.

[00:00 TC/UB Setup] [Time Code] [Mode]

2 Select the desired option and then press SET.

€ If you selected [Regen.], you do not need to perform the rest of this procedure. If you selected [Preset] and would like to set the time code's initial value, see the following section *Setting the Time Code's Initial Value*.

3 After you select [Preset], open the time code [Run] submenu.

[00:00 TC/UB Setup] [Time Code] [Run]

4 Select the desired option and then press SET.

**Options**

- [Preset]: The time code starts from an initial value you can select in advance. The default initial time code is 00:00:00.00. The time code's running mode depends on the [Run] setting.
- [Rec Run]: The time code runs only while recording so clips recorded consecutively on the same CF card will have continuous time codes.
- [Free Run]: The time code starts running the moment you press SET to select this option and keeps running regardless of the camera's operation.
- [Regen.]: The camera will read the selected CF card and the time code will continue from the last recorded time code on the CF card. The time code runs only while recording so clips recorded consecutively on the same CF card will have continuous time codes.

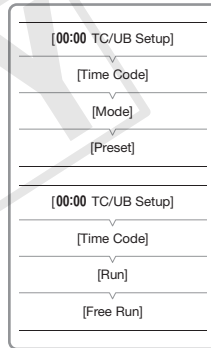

When a procedure requires selecting an option, the available options are listed within or after the procedure. Brackets [ ] are used to refer to menu options as they are displayed on screen.

When a function requires the use of the menu, the quick reference shows the submenus and, when applicable, the default setting for the menu item. The example illustration indicates that you can find the function by selecting the [00:00 TC/UB Setup] menu and then the [Time Code] menu item.

## Supplied Accessories

The following accessories are supplied with the camera.

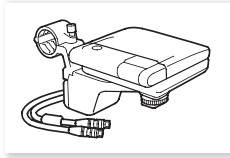

Monitor Unit



Handle Unit

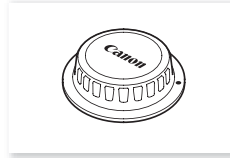

Body Cap<sup>1</sup>

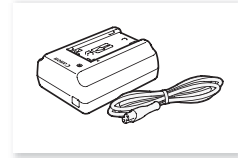

Battery Charger CG-940  
(incl. power cord)

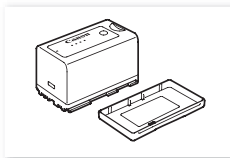

BP-955 Battery Pack  
(incl. terminal cover)



Eye Cup



Viewfinder Cap



CA-941 Compact Power Adapter  
(incl. power cord)

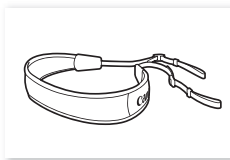

SS-1200 Shoulder Strap

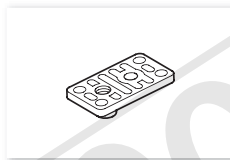

Adapter Base for 0.64 cm (1/4 in.)  
Tripods

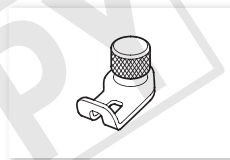

WFT Attachment Bracket<sup>2</sup>

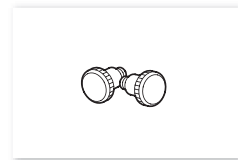

Tape Measure Hooks<sup>1</sup> (x 2)

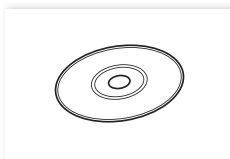

Canon XF Utilities Disc<sup>3</sup>





<sup>1</sup> Comes pre-attached to the camera.

<sup>2</sup> Used to secure the optional WFT-E6 Wireless File Transmitter, when it is attached to the camera.

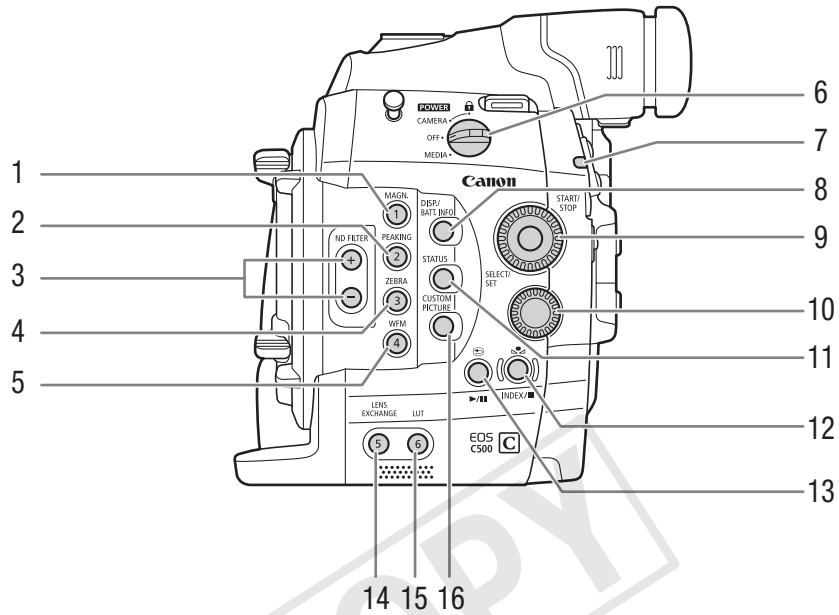
<sup>3</sup> The Canon XF Utilities Disc includes software for saving and managing MXF clips on a computer. For details on installing the software, refer to *Saving MXF Clips to a Computer* (153). For more information on the functions, refer to the 'Canon XF Utility Instruction Manual' (PDF file) after you install the software.

## Names of Parts



- |  |  |
|--|--|
| <p>1 MAGN. (magnification) button (📖 80)/<br/>Assignable button 1 (📖 111)</p> <p>2 PEAKING button (📖 80) /<br/>Assignable button 2 (📖 111)</p> <p>3 ND FILTER +/- buttons (📖 73)</p> <p>4 ZEBRA button (📖 83)/<br/>Assignable button 3 (📖 111)</p> <p>5 WFM (waveform monitor) button (📖 100)/<br/>Assignable button 4 (📖 111)</p> <p>6 <b>POWER</b> switch (📖 26)</p> <p>7 Tally lamp (📖 51)</p> <p>8 DISP. (display) button (📖 55,127)/BATT. INFO<br/>(battery information) button (📖 24)</p> <p>9 SELECT dial/SET button (📖 29)</p> | <p>10 Control dial (📖 71, 74)</p> <p>11 STATUS button (📖 180)</p> <p>12  (white balance adjustment) button (📖 76)/<br/>INDEX button (📖 126)/ (stop) button (📖 126)</p> <p>13  (review recording) button (📖 104)/ (play/pause) button (📖 126)</p> <p>14 LENS EXCHANGE button (📖 34)/Assignable<br/>button 5 (📖 111)</p> <p>15 LUT (lookup table) button (📖 146)/Assignable<br/>button 6 (📖 111)</p> <p>16 CUSTOM PICTURE button (📖 114)</p> |
|--|--|

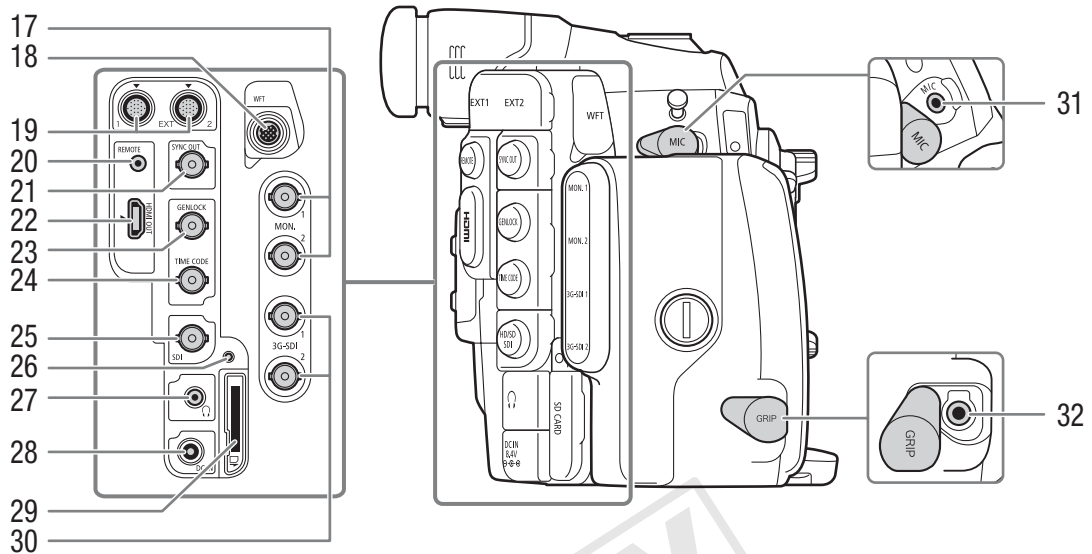

- 17 MON. (external monitor) terminals 1 and 2 ( 41)
- 18 WFT terminal ( 49)
- 19 EXT (modular unit) terminals 1 and 2 ( 35)
- 20 REMOTE terminal  
For connecting commercially available remote controllers.
- 21 SYNC OUT (synchronizing signal output) terminal ( 90,148)
- 22 HDMI OUT terminal ( 147)
- 23 GENLOCK terminal ( 88)
- 24 TIME CODE terminal ( 89, 91)
- 25 HD/SD SDI terminal ( 147)
- 26 SD card access indicator ( 44)
- 27 (headphone) terminal ( 96)
- 28 DC IN terminal ( 25)
- 29 3G-SDI terminals 1 and 2 ( 41)
- 30 SD card slot ( 44)
- 31 MIC (microphone) terminal ( 92)
- 32 GRIP terminal  
This terminal is the same as the grip unit connection terminal on the C300 / C300 PL or C100 camcorder.

**C500**

**C500PL**

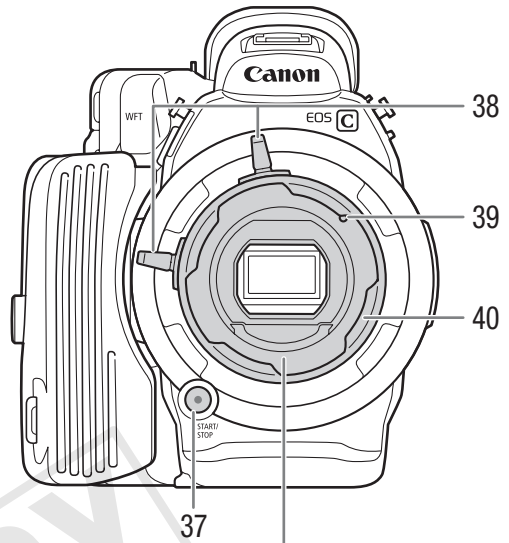
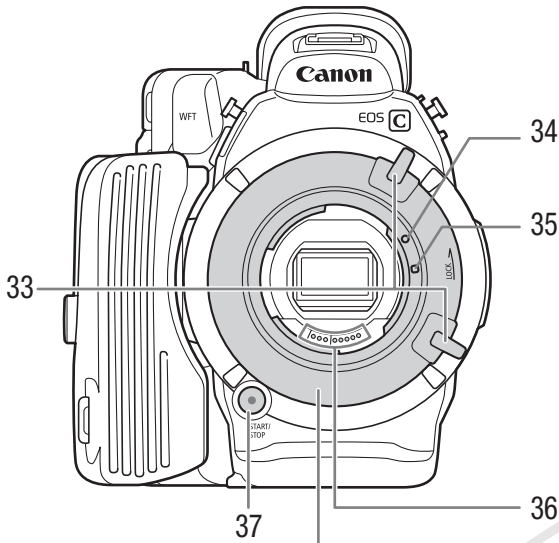

**C500 EF Lens mount**

**C500PL PL Lens mount**

- 33 Mount handle (📖 33)
- 34 EF Lens mount index (📖 32)
- 35 EF-S Lens mount index (📖 32)
- 36 EF Lens contacts (📖 32)
- 37 START/STOP button (📖 51)

- 38 Bayonet ring handles (📖 35)
- 39 PL Lens index pin (📖 35)
- 40 Bayonet ring (📖 35)



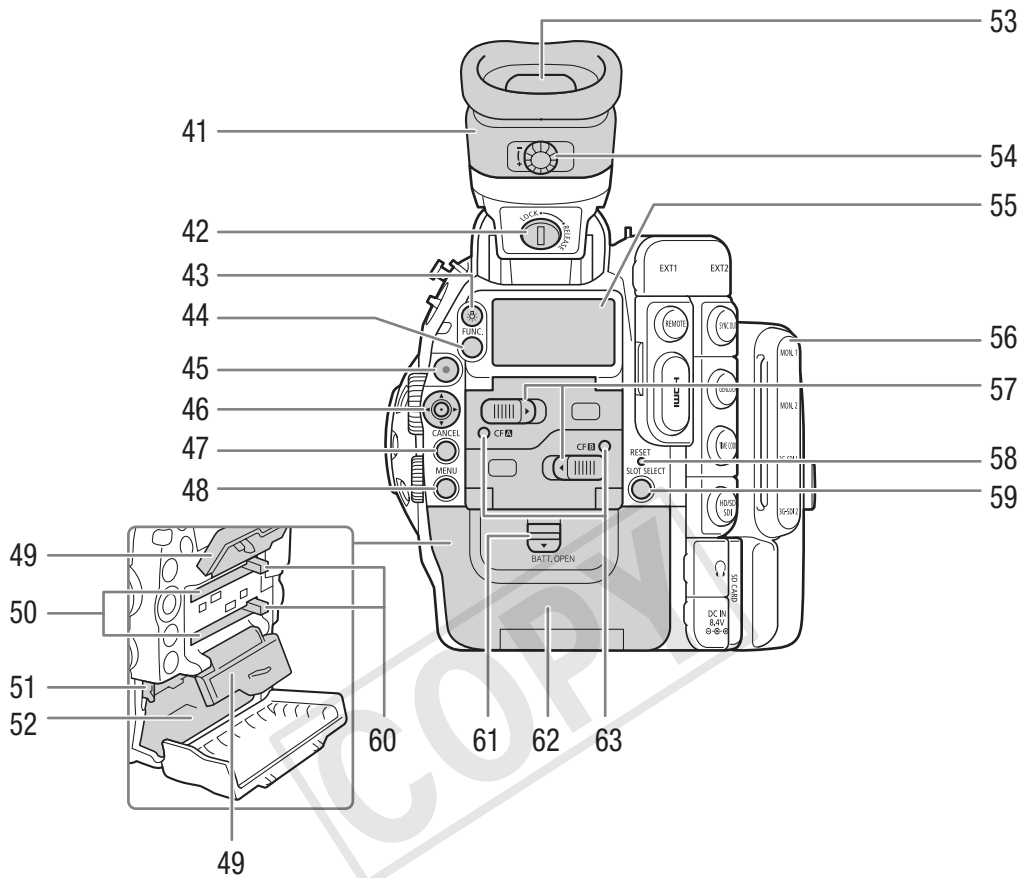

- |   |  |
|---|--|
| 41 Viewfinder unit  | 55 Rear panel ( 57)  |
| 42 Viewfinder unit LOCK/RELEASE screw ( 197)                    | 56 MON./3G-SDI terminal cover ( 41)  |
| 43 $\text{☼}$ (rear panel's backlight) button ( 57)             | 57 CF card slot cover switches for CF card slots A (top) and B (bottom) ( 43)            |
| 44 FUNC. (main functions) button ( 66)                          | 58 RESET button ( 189)   |
| 45 START/STOP button ( 51)                                      | 59 SLOT SELECT (CF card slot selection) button ( 46, 126)                                |
| 46 Joystick ( 29)/SET button ( 29)                              | 60 CF card release buttons for CF card slots A (top) and B (bottom) ( 44)                |
| 47 CANCEL button ( 29)  | 61 BATT. OPEN (open battery compartment) switch ( 24)                                    |
| 48 MENU button ( 29)  | 62 Battery compartment cover ( 24)   |
| 49 CF card slot covers for CF card slots A (top) and B (bottom) | 63 CF <b>A</b> (CF card slot A) and CF <b>B</b> (CF card slot B) access indicators ( 43) |
| 50 CF card slots A (top) and B (bottom) ( 43)                   |  |
| 51 RELEASE (battery release) latch ( 24)                        |  |
| 52 Battery compartment  |  |
| 53 Viewfinder ( 36, 38)   |  |
| 54 Diopter adjustment dial ( 36)                                |  |

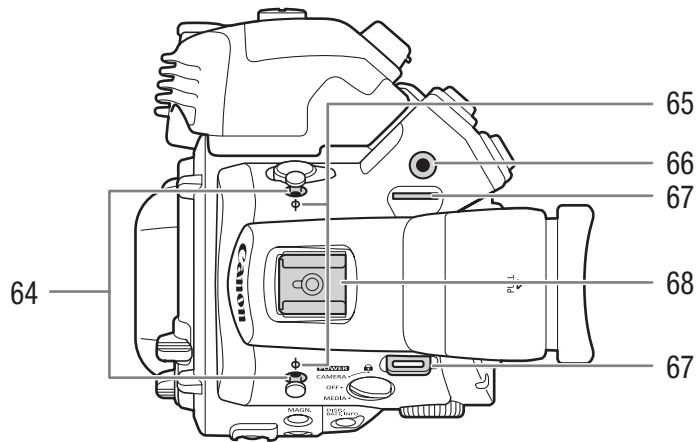

- 64 Tape measure hooks  
Use the hooks to accurately measure the distance from the focal plane.
- 65  $\phi$  Focal plane marks
- 66 Socket for the WFT Attachment Bracket (📖 49)

- 67 Strap mounts (📖 39)
- 68 Accessory shoe with mounting hole for 0.64 cm (1/4 in.) screws  
For attaching accessories such as the optional VL-10Li II Battery Video Light.

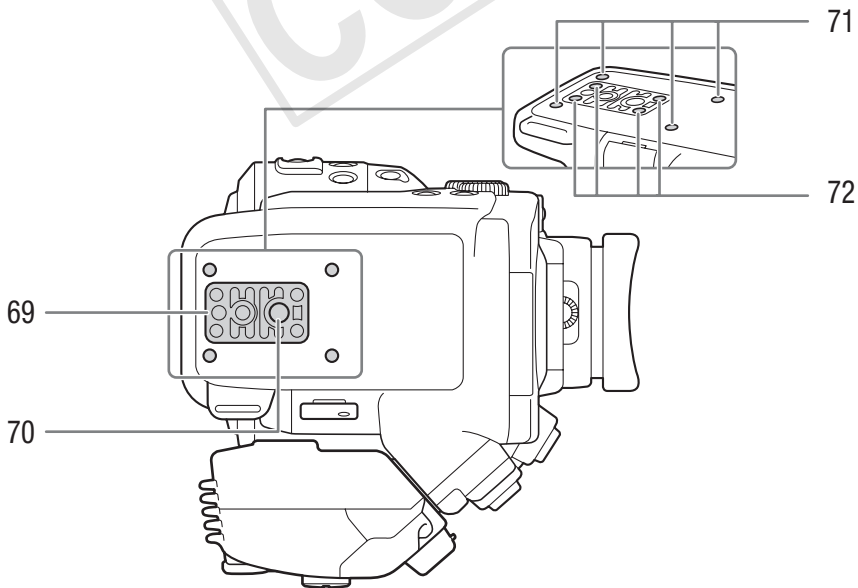

- 69 TB-1 Tripod Base for tripods with 0.95 cm (3/8 in.) screws (📖 38)
- 70 Tripod socket (📖 38)

- 71 Attachment sockets for the optional TA-100 Tripod Adapter (📖 38)
- 72 Tripod base screws (📖 38)

## Monitor Unit

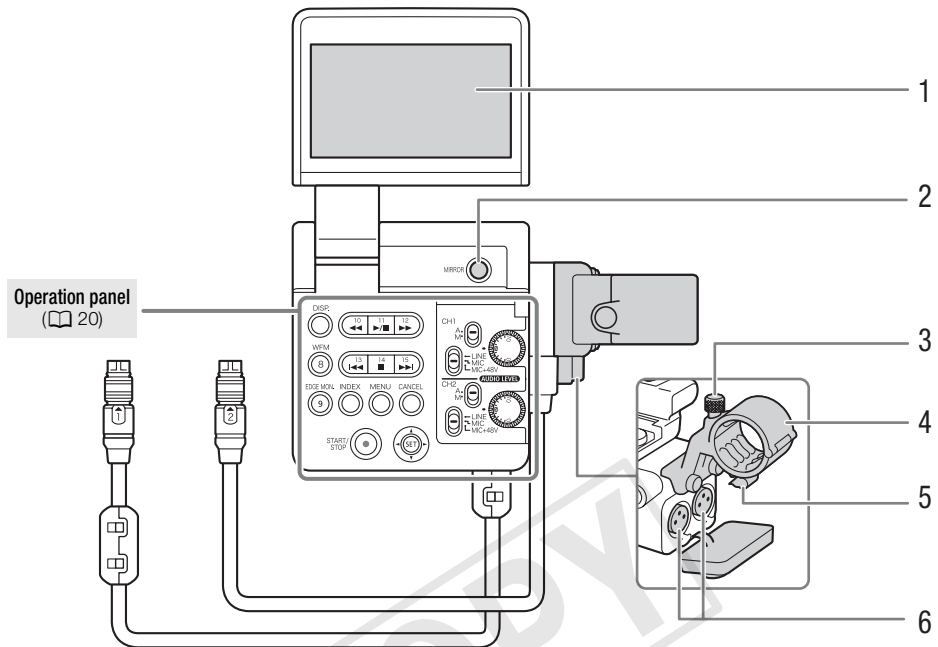

- |                               |  |
|-------------------------------|--|
| 1 LCD panel                   | 4 Microphone holder ( 92)                        |
| 2 MIRROR button ( 37)         | 5 Microphone cable clamp ( 92)                   |
| 3 Microphone lock screw ( 92) | 6 XLR terminals CH1 (right) and CH2 (left) ( 92) |

## Handle Unit

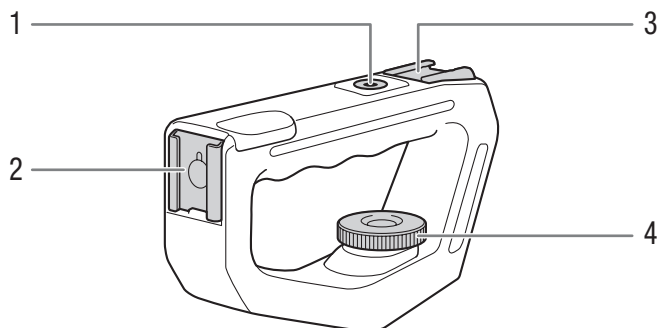

- |  |                      |
|--|----------------------|
| 1 Mounting hole for 0.64 cm (1/4 in.) screws | 3 Top accessory shoe |
| 2 Front accessory shoe                       | 4 Lock screw ( 39)   |

## Operation panel

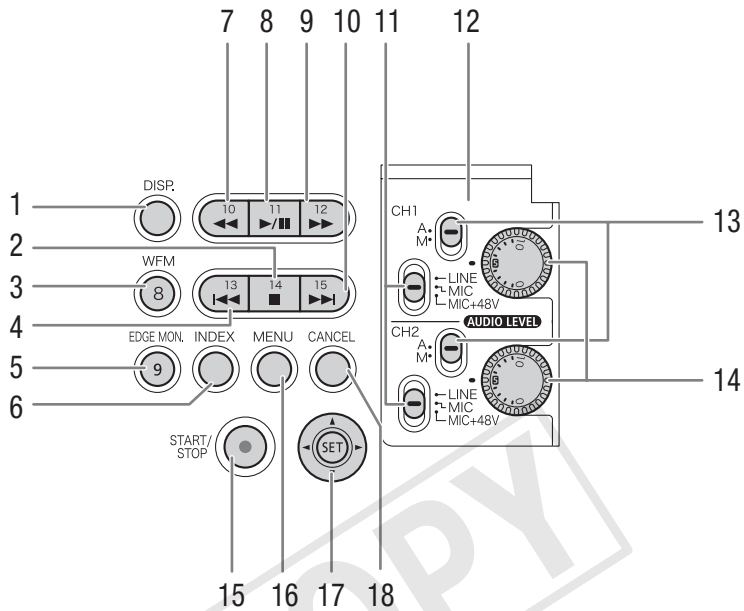

- |   |  |    |   |
|---|--|----|---|
| 1 | DISP. (display) button ( 55, 127)  | 10 | ▶▶  (skip forward) button ( 128)/<br>Assignable button 15 ( 111)    |
| 2 | ■ (stop) button ( 126)/<br>Assignable button 14 ( 111)                   | 11 | XLR terminal switches for CH1 (top) and CH2<br>(bottom) ( 93)       |
| 3 | WFM (waveform monitor) button ( 100)/<br>Assignable button 8 ( 111)      | 12 | Protective cover for XLR audio controls ( 94)                       |
| 4 | ◀◀ (skip backward) button ( 128)/<br>Assignable button 13 ( 111)         | 13 | <b>AUDIO LEVEL</b> switches for CH1 (top) and CH2<br>(bottom) ( 94) |
| 5 | EDGE MON. (edge monitor) button ( 100)/<br>Assignable button 9 ( 111)    | 14 | <b>AUDIO LEVEL</b> dials for CH1 (top) and CH2 (bottom)<br>( 94)    |
| 6 | INDEX button ( 126)  | 15 | START/STOP button ( 51)   |
| 7 | ◀◀ (fast reverse playback) button ( 128)/<br>Assignable button 10 ( 111) | 16 | MENU button ( 29)   |
| 8 | ▶/   (play/pause) button ( 126)/<br>Assignable button 11 ( 111)          | 17 | Joystick ( 29)/SET button ( 29)                                     |
| 9 | ▶▶ (fast playback) button ( 128)/<br>Assignable button 12 ( 111)         | 18 | CANCEL button ( 29)   |

## 4K Workflow Overview

The following illustrates the typical 4K workflow for this camera.

Operating modes: CAMERA MEDIA | 4K 2K MXF

21

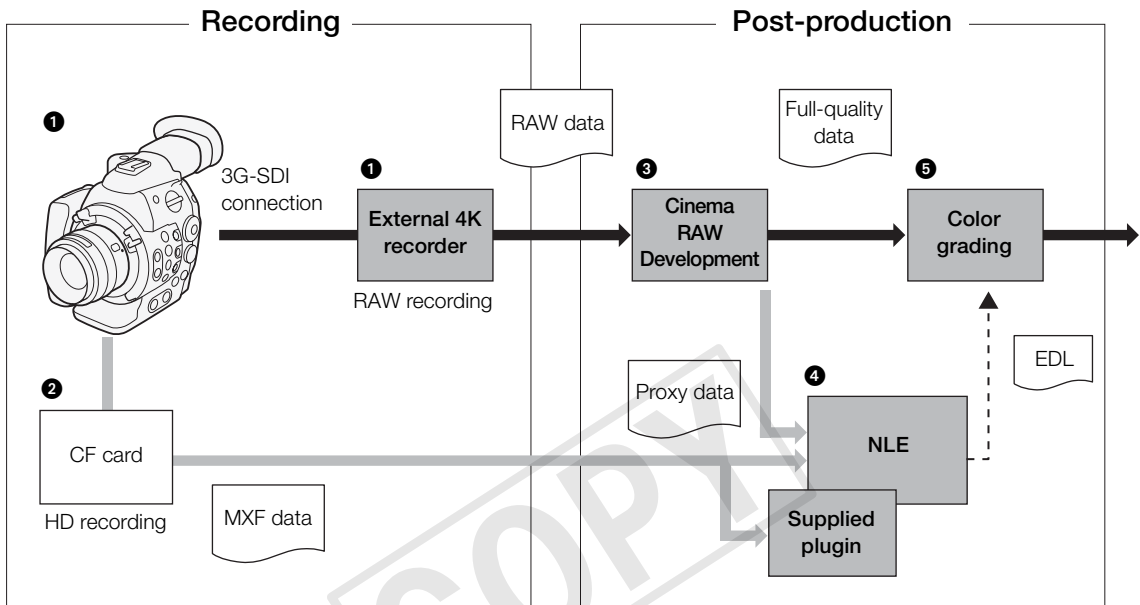

- ❶ Shoot in 4K mode (📖 60) and record 4K RAW data using an external recorder connected to the camera's 3G-SDI terminals (📖 41).
- ❷ Insert a CF card into the camera to record an MXF clip simultaneously with the 4K RAW data (📖 63).
- ❸ Develop the RAW data using the **Cinema RAW Development** software (📖 150) to generate full-quality data.
  - You can also generate proxy data with the software.
- ❹ Transfer the MXF file or proxy data generated by the software to your NLE system and edit offline (📖 153).
- ❺ Perform color grading based on the full-quality data and the edit decision list (EDL) created from offline editing.

## Color Grading with the ACES Workflow

22

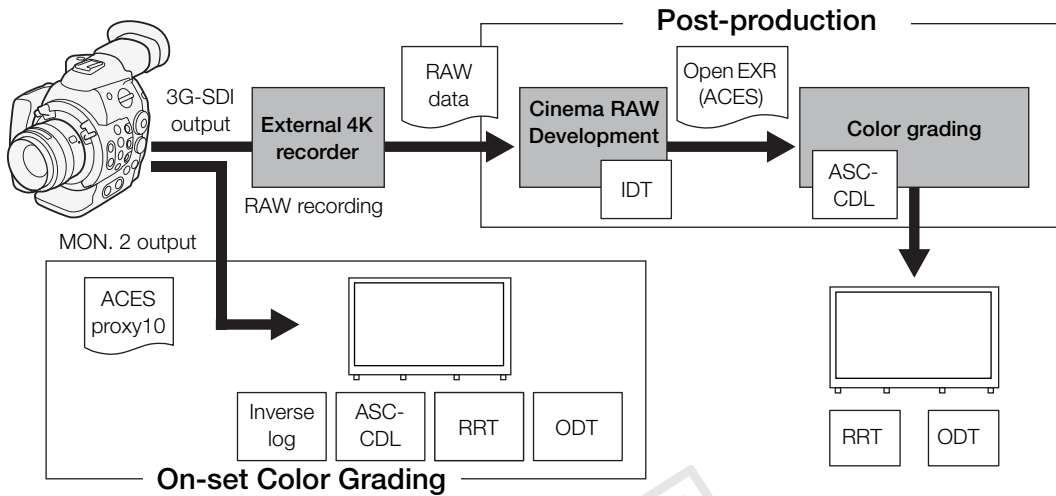

ACESproxy10: ACESproxy10 video data that is output from the MON. 2 terminal when performing on-set color grading. Use the [4K/2K/MXF] [MON. 1 & 2] [ACESPX10] setting to enable ACESproxy10 output.

ASC-CDL: Refers to the list that contains color grading adjustment data. This step requires equipment compatible with ASC-CDL.

IDT: Input Device Transform. Refers to the table used for converting color information of the input device to ACES color space.

ODT: Output Device Transform. Refers to the table used for converting ACES color space information to the color information of the ideal display device.

RRT: Reference Rendering Transform. Refers to the table used for converting data from ACES color space to the color information of the ideal display device.

## Preparing the Power Supply

You can power the camera using a battery pack or directly using the compact power adapter. If you connect the compact power adapter to the camera while a battery pack is attached, the camera will draw power from the power outlet.

Charge battery packs before use. For approximate charging times and recording/playback times with a fully charged battery pack, refer to *Charging Times* (☞ 201) and *Recording and Playback Times* (☞ 201).

### Using a Battery Pack

You can power the camera using the supplied BP-955 or an optional BP-950G, BP-970G or BP-975 Battery Pack\*. The BP-955 and BP-975 are compatible with Intelligent System, meaning that you can check the remaining battery time.

\* The optional BP-970G / BP-975 Battery Pack was not originally designed for use with this camera. Because of its size, you will not be able to close the battery compartment cover when using one (☞ 195).

### Charging the Battery Pack

Charge battery packs using the supplied CG-940 Battery Charger. Before charging, remove the terminal cover of the battery pack.

- 1 Connect the power cord to the battery charger.
- 2 Plug the power cord into a power outlet.
- 3 Attach the battery pack to the battery charger.
  - Press lightly and slide the battery pack in the direction of the arrow until it clicks.
  - The CHARGE indicator starts flashing and also indicates the battery pack's approximate charge. The indicator will stay on when charging has completed.

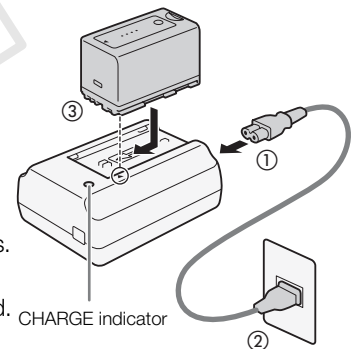

|           |                                    |
|-----------|------------------------------------|
| * .....   | 0-34%: Flashes once per second     |
| ** .....  | 35-69%: Flashes twice per second   |
| *** ..... | 70-99%: Flashes 3 times per second |

- 4 When charging has completed, remove the battery pack from the battery charger.
- 5 Unplug the power cord from the power outlet and disconnect it from the battery charger.

#### ! IMPORTANT

- Do not connect to the battery charger any product that is not expressly recommended for use with this camera.

#### i NOTES

- We recommend charging the battery pack in temperatures between 10 °C and 30 °C (50 °F and 86 °F). Outside the temperature range of 0 °C to 40 °C (32 °F to 104 °F), charging will not start.
- If there is a malfunction with the battery charger or battery pack, the CHARGE indicator will go out and charging will stop.
- For handling precautions regarding the battery pack, refer to *Battery Pack* (☞ 194).
- Charged battery packs continue to discharge naturally. Therefore, charge them on the day of use, or the day before, to ensure a full charge.
- We recommend that you prepare battery packs to last 2 to 3 times longer than you think you might need.

### Attaching the Battery Pack

- 1 Set the **POWER** switch to OFF.
- 2 Slide the BATT. OPEN switch in the direction of the arrow and open the battery compartment cover.
- 3 Insert the battery pack all the way into the compartment as shown in the illustration and press it gently toward the left until it clicks.
- 4 Close the battery compartment cover.

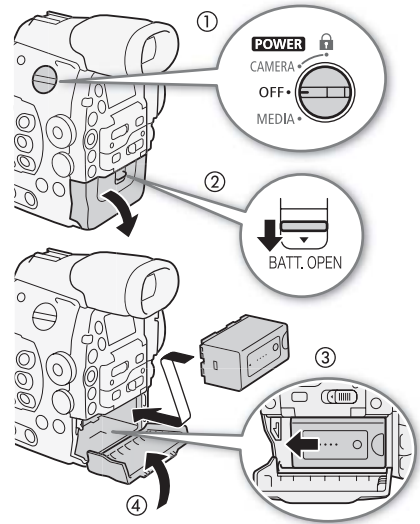

### Removing the Battery Pack

- 1 Set the **POWER** switch to OFF.
- 2 Slide the BATT. OPEN switch in the direction of the arrow and open the battery compartment cover.
- 3 Holding down the RELEASE latch, slide the battery pack toward the right and then pull it out.
- 4 Close the battery compartment cover.

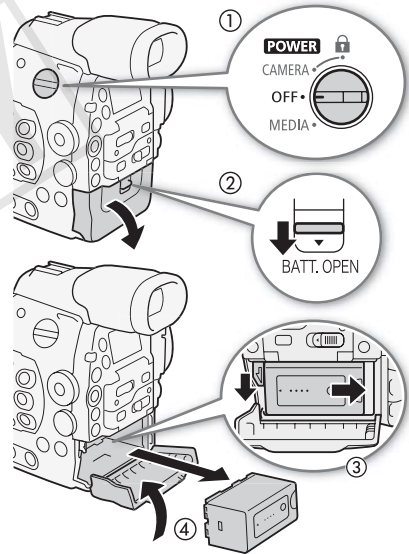

### Checking the Remaining Battery Charge

When the camera is turned on, you can check the remaining battery charge by looking at any recording/playback screen or the [Battery/Hour Meter] status screen (185). When the camera is turned off, use one of the following methods to check the approximate remaining battery charge.

For batteries compatible with Intelligent System, press the CHECK button. An indicator will light for approximately 3 seconds and show the approximate remaining battery charge.

|         |         |
|---------|---------|
| ☼ ○ ○ ○ | 0-25%   |
| ☼ ☼ ○ ○ | 26-50%  |
| ☼ ☼ ☼ ○ | 51-75%  |
| ☼ ☼ ☼ ☼ | 76-100% |

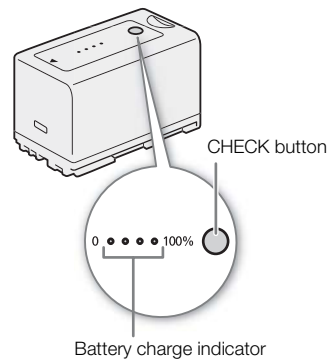



Press the BATT. INFO button to display the remaining battery charge (for 5 seconds). Depending on the battery life, the battery information may not be displayed.

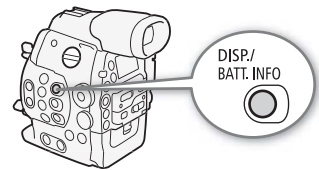

### **i** NOTES

- The first time you use a battery pack, fully charge it and then use the camera until the battery pack is completely exhausted. Doing so will ensure that the remaining recording time will be displayed accurately.
- Repeatedly charging and discharging the battery pack will eventually shorten its battery life. You can check the battery life on the [Battery/Hour Meter] status screen (185) or the battery information screen (press the BATT. INFO button while the camera is turned off). Fully charging the battery pack and then discharging it will give you a more accurate reading.

## Using a Household Power Outlet

You can also power the camera directly from a power outlet using the supplied CA-941 Compact Power Adapter.

- 1 Set the **POWER** switch to OFF.
- 2 Connect the compact power adapter's DC plug to the DC IN terminal on the camera.
- 3 Connect the power cord to the compact power adapter and plug it into a power outlet.

### **!** IMPORTANT

- Turn off the camera before connecting or disconnecting the compact power adapter.

### **i** NOTES

- When using the camera with a household power outlet, you can change the battery pack while the power is on.

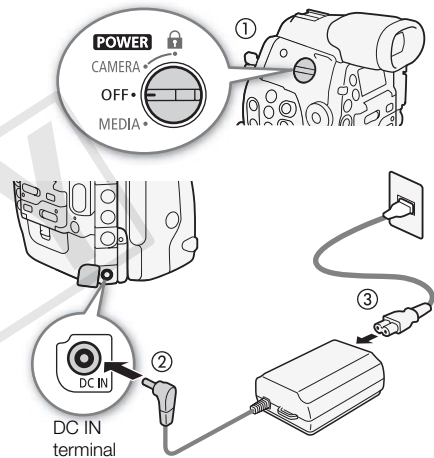

### Turning the Camera On and Off

The camera has two operating modes: CAMERA (CAMERA) mode for making recordings and MEDIA (MEDIA) mode for playing back recordings. Select the operating mode using the **POWER** switch.

26

#### To turn on the camera

Set the **POWER** switch to CAMERA for CAMERA mode or MEDIA for MEDIA mode.

- If a message appears prompting you to open the MON./3G-SDI terminal cover, open the cover to shoot in 4K or 2K mode.

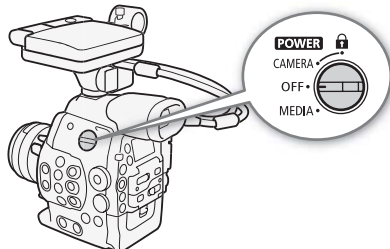
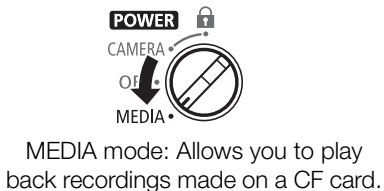

#### To turn off the camera

Set the **POWER** switch to OFF.

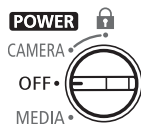

COPY

## Date, Time and Language Settings

### Setting the Date and Time

You will need to set the date and time of the camera before you can start using it. When the camera's clock is not set, the [Date/Time] screen will appear automatically with the first field selected (month or day, depending on the country/region of purchase).

Operating modes: CAMERA MEDIA | 4K 2K MXF

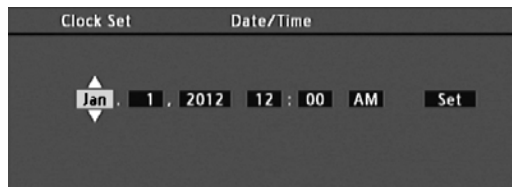

- 1 Push the joystick up/down or turn the SELECT dial to change the month/day then move (▶) to the next field.
  - To move to the next field you can also press SET (press the joystick itself or press the SET button).
- 2 Change the rest of the fields in the same way.
- 3 Select (▶) [Set] and then press SET to start the clock and close the screen.

#### **i** NOTES

- You can change the date format and the clock format (12/24 hours) with the [⏏ Other Functions] ⏏ [Set Clock] ⏏ [Date Format] setting.
- You can also change the date and time later on (not during the initial setup) with the [⏏ Other Functions] ⏏ [Set Clock] ⏏ [Date/Time] setting.
- When the built-in rechargeable lithium battery is exhausted, the date and time setting may be lost. In such case, recharge the built-in lithium battery (📖 196) and set the time zone, date and time again.

### Changing the Time Zone

Change the time zone to match the time zone of your location. The default setting is [UTC-05:00 New York] or [UTC+01:00 Central Europe], depending on the country/region of purchase. The time zones are based on Coordinated Universal Time (UTC).

Operating modes: CAMERA MEDIA | 4K 2K MXF

- 1 Press the MENU button.
- 2 Push the joystick up/down or turn the SELECT dial to select [⏏ Other Functions].
- 3 Select [Time Zone] in a similar fashion.
- 4 Push the joystick up/down or turn the SELECT dial to change the time zone.
- 5 Press SET to set the time zone and then press the MENU button to close the menu.

[⏏ Other Functions]

[Time Zone]

[UTC-05:00 New York]  
or  
[UTC+01:00 Central Europe]\*

\* Depending on the country/region of purchase.

## Displaying the Date and Time while Recording

You can display the date and time on the screen.

Operating modes: CAMERA MEDIA | 4K 2K MXF

- 1 Press the MENU button.
- 2 Push the joystick up/down or turn the SELECT dial to select [LCD/VF Setup].
- 3 Select [Custom Display 2] and then [Date/Time] in a similar fashion.
- 4 Push the joystick up/down or turn the SELECT dial to select the information to display.
  - Select [Off] to record without displaying the date and time.
- 5 Press SET and then press the MENU button to close the menu.
  - The selected date/time display will appear at the bottom of the screen.

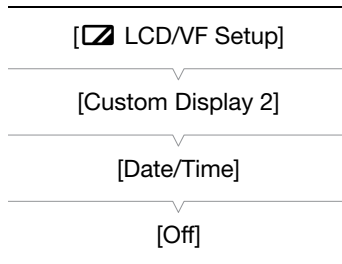

## Changing the Language

The default language of the camera is English. You can change it to German, Spanish, French, Italian, Polish, Russian, Simplified Chinese, Korean or Japanese. Please note that some settings and screens will be displayed in English, regardless of the language setting.

Operating modes: CAMERA MEDIA | 4K 2K MXF

- 1 Press the MENU button.
- 2 Push the joystick up/down or turn the SELECT dial to select [Other Functions].
- 3 Select [Language] in a similar fashion.
- 4 Push the joystick up/down or turn the SELECT dial to select a language.
- 5 Press SET to change the language and then press the MENU button to close the menu.

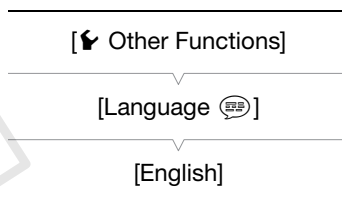

## Using the Menus

In **CAMERA** mode, many of the camera's functions can be adjusted from the menu for general settings, which opens after pressing the MENU button. You can also register frequently used menu settings in a customized submenu (My Menu) for easy access. In **MEDIA** mode, press the MENU button to open the menu for general settings or SET to open the clip menu for clip operations. For details about the available menu options and settings, refer to *Menu Options* (□ 169).

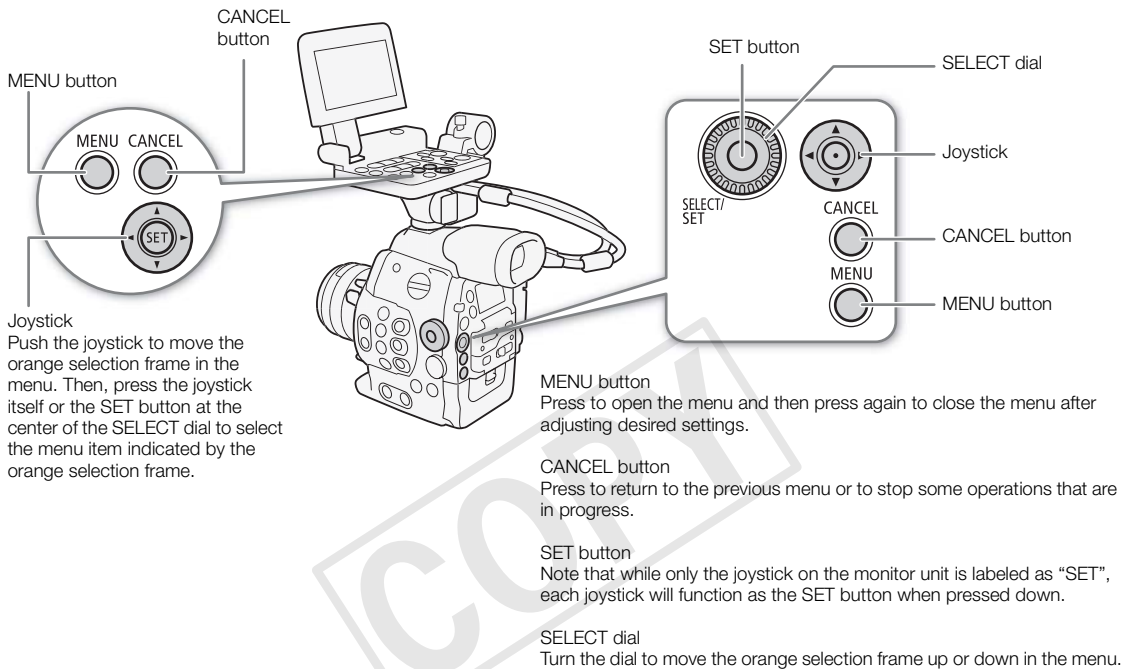

## Selecting an Option from the Menu

The following is a step-by-step explanation of how to select an option from the menu. In the procedures throughout the rest of this manual, opening and closing the menu is assumed and not included in the procedure.

Operating modes: **CAMERA** **MEDIA** | **4K** **2K** **MXF**

### 1 Press the MENU button.

- The menu opens with the orange selection frame indicating the menu item that was selected the previous time the menu was closed (unless the camera was turned off).

### 2 Push the joystick up/down or turn the SELECT dial to select the desired submenu.

### 3 Push the joystick right or press SET.

- The orange selection frame will appear on a menu item in the submenu.
- Press the CANCEL button, push the joystick left, or select [↩] to return to the previous submenu.

### 4 Push the joystick up/down or turn the SELECT dial to select the desired menu item.

- If a submenu contains many menu items, a scroll bar will appear on the right side of the submenu indicating that you must scroll up or down to see other menu items.
- A ► mark next to a menu item indicates another submenu. Repeat steps 3 and 4.

**5 Push the joystick right or press SET.**

- The orange selection frame will appear on a setting option.
- Press the CANCEL button to return to the previous submenu.

**6 Push the joystick up/down or turn the SELECT dial to select the desired setting option and then press SET.**

- Depending on the menu item, additional selections may be necessary.

**7 Press the MENU button to close the menu.****i NOTES**

- Unavailable items may appear grayed out.
- Pressing the MENU button at any time closes the menu.
- You can check some of the current settings on the status screens (📖 180).

**Using the Customized Submenu (My Menu)**

You can register up to 14 frequently used menu settings under the My Menu submenu for easy access. Furthermore, if you set an assignable button to [My Menu] (📖 111), you can press the button to access your registered menu settings even faster and more easily.

Operating modes: CAMERA MEDIA | 4K 2K MXF

**Adding Menu Settings**

1 Open the My Menu [Register] screen.

[★ My Menu] ➡ [Edit] ➡ [Register]

- The menu will change to blue to indicate you are selecting menu settings to add to the My Menu submenu.
- Press the CANCEL button to cancel the operation and return to the regular menu.

2 Navigate the menus to find the menu setting you want to add and then press SET.

3 Select [OK] and then press SET twice.

- The menu setting you registered will now appear under the My Menu submenu.
- Select [Cancel] instead to cancel the operation.

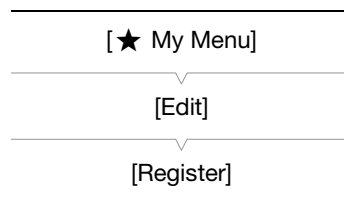
**Rearranging Menu Settings**

1 Open the My Menu [Move] screen.

[★ My Menu] ➡ [Edit] ➡ [Move]

2 Push the joystick up/down or turn the SELECT dial to select the setting you want to move and then press SET.

- An orange ⬆ icon will appear next to the setting you selected to move.

3 Push the joystick up/down or turn the SELECT dial to move the setting to the desired position and then press SET.

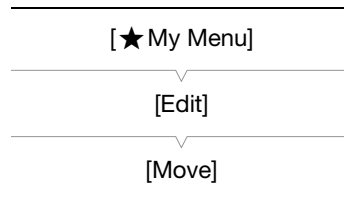

### Removing Menu Settings

- 1 Open the My Menu [Delete] screen.  
[★ My Menu] ➤ [Edit] ➤ [Delete]
- 2 Push the joystick up/down or turn the SELECT dial to select the setting you want to remove and then press SET.
- 3 Select [OK] and then press SET twice.

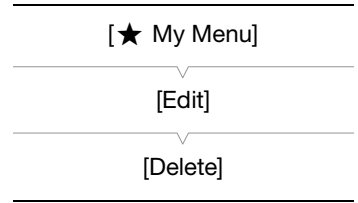

### Resetting the My Menu Submenu

- 1 Reset all the menu settings registered to the My Menu submenu.  
[★ My Menu] ➤ [Edit] ➤ [Reset All]
- 2 Select [OK] and then press SET twice.



COPY

## Preparing the Camera

This section outlines the basic preparations for the camera such as attaching a lens and attaching the modular units to the camera: monitor unit, handle unit, eye cup, etc. This section also covers how to adjust the viewfinder and LCD screen. Your camera is nothing if not versatile and you can choose the configuration that best fits your needs and shooting conditions.

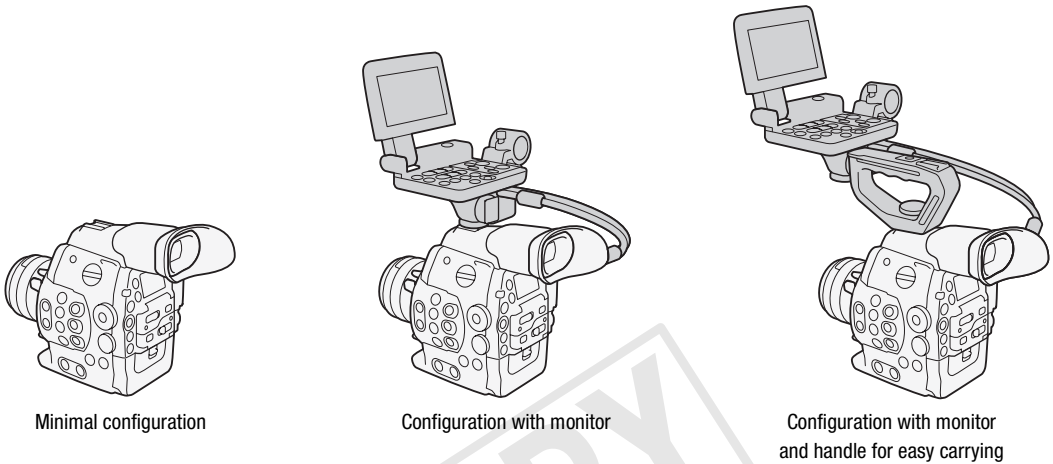

### **i** NOTES

- When changing the camera's configuration, be careful not to obstruct in any way the cooling fan's air vents.

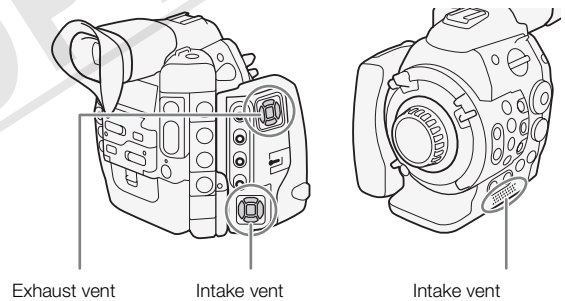

## Preparing the Lens

As much as possible, attach and remove the lens quickly and in a clean environment free of dust. Refer also to the instruction manual of the lens used.

### **!** IMPORTANT

- When attaching/removing a lens, avoid direct sunlight or strong light sources. Also, be careful not to drop the camera or lens.

### **i** NOTES

- Be careful not to touch the lens mount or any components inside the lens mount area.
- Replace the body cap to the lens mount immediately after removing the lens from the camera.
- Keep the body cap clean and free from dust or dirt particles.



**C500** Attaching an EF Lens

- 1 Set the **POWER** switch to OFF.
- 2 Turn the mount handle clockwise until it stops.
- 3 Remove the body cap from the camera and any dust caps from the lens.
- 4 Align the lens and mount making sure that the index marks are aligned.
  - EF lenses: Align the red mark on the lens with the red EF Lens mount index mark on the camera.
  - EF-S lenses: Align the white mark on the lens with the white EF-S Lens mount index mark on the camera.
- 5 After the lens is attached to the camera, without turning the lens, turn the mount handle counter-clockwise until it is tightened firmly.

**i** NOTES

- Turning on the image stabilization function of an EF lens may reduce the effective usage time of the battery pack. When image stabilization is not necessary, for example if the camera is fixed to a tripod, it is recommended to turn it off.
- Depending on the lens used, you may experience one or more of the following limitations.
  - The lens model name may be shortened when displayed on the screen.
  - You may not be able to focus manually when the focus mode switch is set to AF.
  - You may not be able to use the focus preset function on super telephoto lenses.
  - You cannot use the power zoom function on lenses with that function.

**C500** Removing an EF Lens

- 1 Set the **POWER** switch to OFF.
- 2 While holding the bottom of the lens, turn the mount handle clockwise until it stops.
  - Make sure not to drop the lens when removing it.
- 3 Replace the body cap to the camera and the dust cap to the lens.

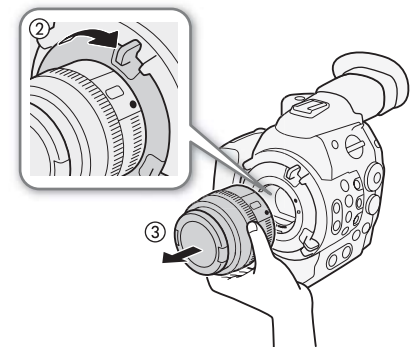
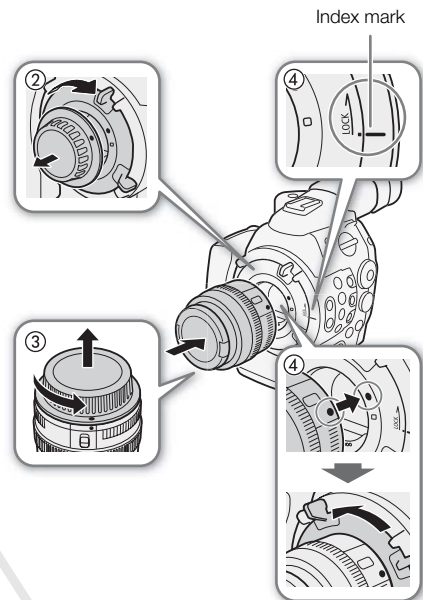

**Changing a Lens While Maintaining the Time Code's Progress**

You can change the lens while the camera is turned on and the time code is running.

Operating modes: CAMERA MEDIA | 4K 2K MXF

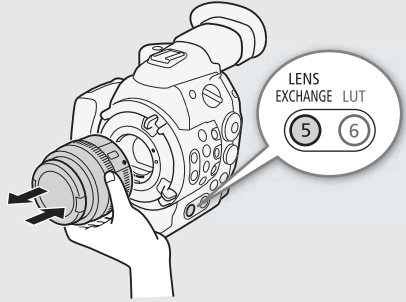

- 1 Press and hold the LENS EXCHANGE button for 1 second.
  - The camera enters lens exchange mode and the tally lamp will flash twice every 2 seconds. During this time, the time code will continue running.
  - While the camera is in lens exchange mode, only the **POWER** switch and LENS EXCHANGE button can be operated. Also, the LCD screen will turn off and output from the video terminals will be put on hold.
- 2 Remove the lens attached to the camera and attach the new lens.
  - Do not set the **POWER** switch to OFF.
- 3 Press the LENS EXCHANGE button again.
  - The camera exits lens exchange mode.
  - Opening the CF card slot cover or removing the SD card will also exit lens exchange mode.

**C500 Peripheral Illumination Correction**

Depending on the characteristics of the lens used, the image around the corners of the picture may seem darker due to light fall-off or peripheral illumination drop. If the camera has correction data available for the EF lens used, it can apply this correction data to compensate as necessary.

Operating modes: CAMERA MEDIA | 4K 2K MXF

- 1 Attach the lens you want to use.
- 2 Open the peripheral illumination correction screen.
  - [Camera Setup] ➤ [Periph. Illum. Corr.]
    - If correction data is available, the lens model name will appear on the screen.
    - If correction data is not available, [Periph. Illum. Corr.] will appear grayed out. Visit your local Canon Web site and check if there is correction data available for the lens you are using. If so, download the necessary update package and upgrade the camera's firmware following the instructions supplied therein.
- 3 Select [On] and then press SET.
  - As long as [Camera Setup] ➤ [Periph. Illum. Corr.] is set to [On], the camera will automatically apply the appropriate correction data.

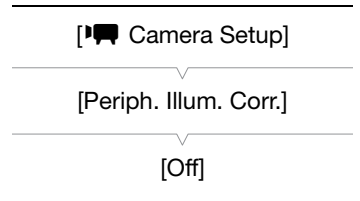

**i** NOTES

- **About lens correction data:**
  - The camera contains a register of correction data for compatible lenses that were available at the time the camera went on sale. Correction data for future lenses will be made available as part of the regular updates released for the camera's firmware. For more details, visit your local Canon Web site.
  - Depending on the recording conditions, noise may appear in the periphery of the image as a result of the correction.
  - The level of correction will be lower for lenses that cannot provide distance information.
  - The level of correction will be lower the higher the ISO speed/gain setting used.
  - No correction will be applied when correction data is not available for the lens attached.
  - When using EF-S lenses, peripheral illumination fall-off may be more pronounced.

- When using non-Canon lenses, peripheral illumination will not be corrected. Even if the [Camera Setup] [Periph. Illum. Corr.] setting is available (not grayed out), it is recommended to set it to [Off].

### **C500 PL** Attaching a PL Lens

- 1 Hold a bayonet ring handle and turn the bayonet ring counter-clockwise to remove the body cap and remove any dust caps from the lens.
- 2 Attach the lens to the camera aligning a groove on the lens with the PL lens index pin on the mount.
- 3 Turn the bayonet ring clockwise to fix the lens in place.

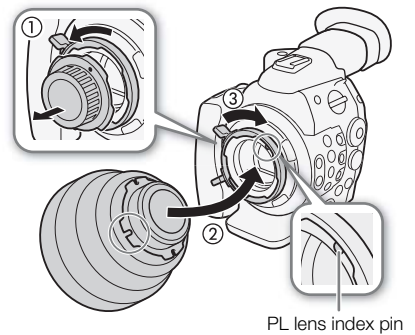

### **C500 PL** Removing a PL Lens

- 1 Turn the bayonet ring handles counter-clockwise.
- 2 Remove the lens and replace the body cap to the camera and the dust cap to the lens.

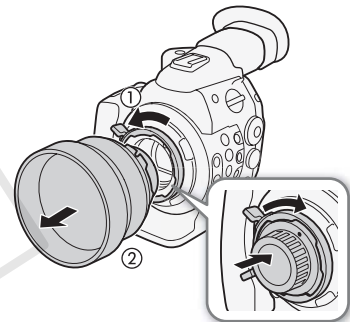

## Attaching and Removing the Monitor Unit

You can attach the monitor unit to the accessory shoe on the camera or that on the handle unit. Further ahead you will find details about using the LCD panel and adjusting the LCD screen (□ 37).

### Attaching the Monitor Unit

- 1 Set the **POWER** switch to OFF.
- 2 Insert the attachment base of the monitor unit to the camera's or the handle unit's accessory shoe.
  - Use the attachment base at the bottom of the monitor unit to attach it directly to the camera. Use the attachment base at the back of the monitor unit to attach it to the accessory shoe on the front of the handle unit.
- 3 Tighten the monitor unit's lock screw.
- 4 Connect the monitor unit's cables to the camera.
  - Align the ▼ marks on the cables and terminals. Then, connect cable number 1 (with the white line) to the camera's EXT 1 terminal and cable number 2 to the EXT 2 terminal.

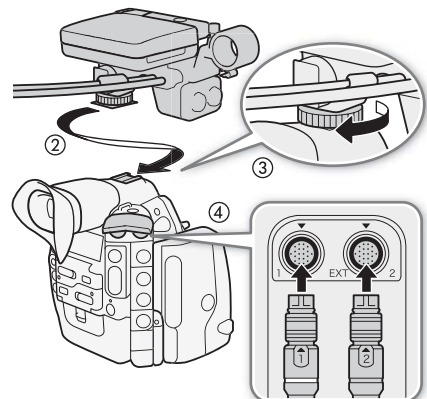

### Removing the Monitor Unit

- 1 Set the **POWER** switch to OFF.
- 2 Disconnect the monitor unit's cables from the camera's EXT 1 and EXT 2 terminals.
  - Pull back the metallic tips of the cable to release the cable and then disconnect the cable.
- 3 Unscrew the lock screw and then gently slide out the monitor unit from the accessory shoe.

## Using the Viewfinder

### Adjusting the Viewfinder's Position

- 1 Gently pull out the viewfinder until it stops.
- 2 Adjust the viewfinder's angle as necessary.
  - The viewfinder unit can be adjusted up to 60° vertically.

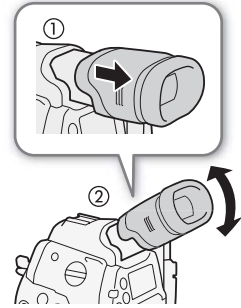

### Attaching and Detaching the Eye Cup

Attach the eye cup so that it covers the rubber portion of the viewfinder unit.

- The dioptic adjustment dial can be operated even with the eye cup attached.
- For left eye use, attach the eye cup so that the protruding portion faces the opposite side.

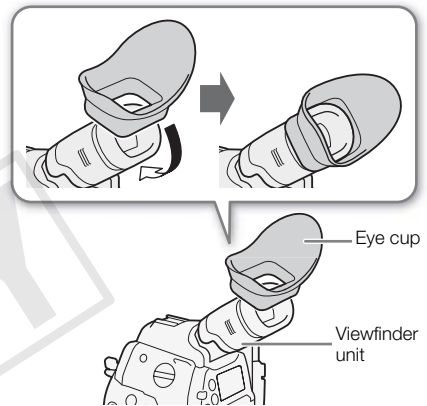

Detach the eye cup as shown in the illustration.

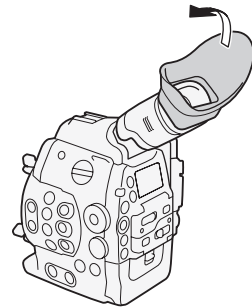

### Dioptic Adjustment

Turn on the camera and adjust the dioptic adjustment dial.

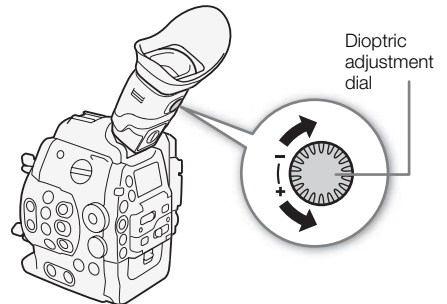

### Attaching the Viewfinder Cap

Pointing the viewfinder lens at the sun or other strong light sources may cause damage to internal components. When you are not using the viewfinder, make sure to attach the viewfinder cap to the viewfinder. This will also protect the viewfinder from scratches and dirt. Attach the viewfinder cap by inserting it into the rubber portion of the viewfinder unit.

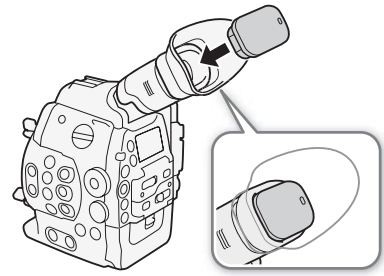

### Using the LCD Panel

The whole monitor unit can be rotated 270° sideways allowing for easy monitoring and operation from the side of the camera. Additionally, the independently articulated LCD panel can be rotated 180° sideways and 270° up and down. In combination, you can position the LCD panel at a comfortable angle whatever the shooting style you need.

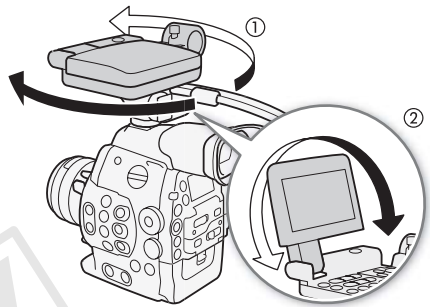

- 1 Rotate the monitor unit sideways to the desired angle.
- 2 Open the LCD panel and adjust the screen to the desired position.

### Adjusting the LCD Panel for Shoulder Mounted Use

- 1 Open the LCD panel 90° until it is perpendicular to the monitor unit.
- 2 Rotate the LCD panel 180° left.
- 3 Rotate the LCD panel 180° forward.
- 4 Press the MIRROR button until the image is displayed in the correct orientation.
  - Repeatedly pressing the MIRROR button will change the displayed image in the following order: Image inverted horizontally → Image inverted horizontally and vertically → Image inverted vertically → Original image.

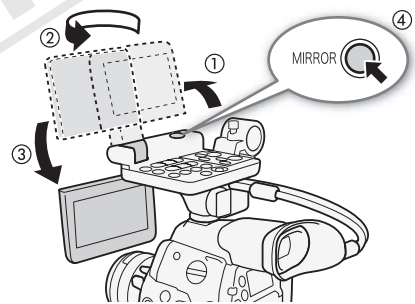

You can use the viewfinder and watch the LCD screen at the same time

### NOTES

- **About the LCD and viewfinder screens:** The screens are produced using extremely high-precision manufacturing techniques, with more than 99.99% of the pixels operating to specification. Less than 0.01% of the pixels may occasionally misfire or appear as black, red, blue or green dots. This has no effect on the recorded image and does not constitute a malfunction.
- You can set the LCD screen to black & white (☐ 38).
- When you use a commercially available lens adapter and the image on the screen is inverted, you can use the [Other Functions] ➤ [Custom Function] ➤ [Scan Reverse Rec] setting to return the image to the correct orientation. You can record this corrected image or have the camera output it from the 3G-SDI terminal, MON. terminal, HD/SD terminal or HDMI OUT terminal.
- If you are not interested in using the viewfinder while the monitor unit is attached, you can set [LCD/VF Setup] ➤ [LCD/VF Simul.] to [Off] to conserve the camera's power. Even when [LCD/VF Simul.] is set to [Off], closing the LCD panel will automatically activate the viewfinder.
- While recording with the LCD panel rotated in a different direction or angle (for example, facing toward the subject), you can press the MIRROR button repeatedly to invert the image on the screen horizontally, vertically or both ways.

## Adjusting the Viewfinder/LCD Screen

You can adjust the brightness, contrast, color, sharpness, and backlight of the viewfinder and LCD screen independently of each other. These adjustments will not affect your recordings.

Operating modes: CAMERA | MEDIA | 4K | 2K | MXF

- 1 Open the setup menu for the viewfinder or LCD screen.  
[ LCD/VF Setup] ➤ [LCD Setup] or [VF Setup]
- 2 Select [Brightness], [Contrast], [Color], [Sharpness] or [Backlight] and then press SET.
- 3 Adjust the setting and then press SET.
  - Repeat steps 2 and 3 to adjust other settings as necessary.

### i NOTES

- If you set an assignable button to [LCD Setup] or [VF Setup] (📖 111), you can press the button to open the respective submenu.

## Setting the Screen to Black & White

The viewfinder and LCD screen display in color by default but you can set them to black & white. Even when the screen is black & white, onscreen text and icons will still be displayed in color.

Operating modes: CAMERA | MEDIA | 4K | 2K | MXF

- 1 Open the [LCD/VF B&W] submenu.  
[ LCD/VF Setup] ➤ [LCD/VF B&W]
- 2 Select [On] and then press SET.

### i NOTES

- If you set an assignable button to [LCD/VF B&W] (📖 111), you can press the button to turn the black & white display on and off.

## Using a Tripod

The camera is shipped with the TB-1 Tripod Base for tripods with 0.95 cm (3/8 in.) screws. You can mount the camera on a tripod but do not use tripods with mounting screws longer than 5.5 mm (0.2 in.) as this may cause damage to the camera.

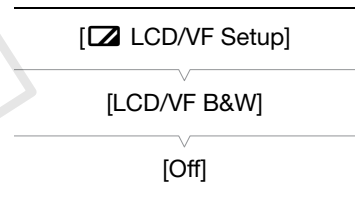
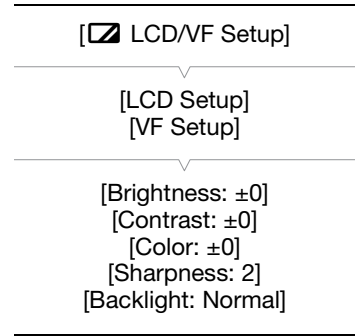
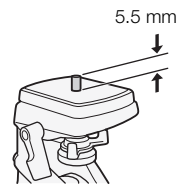

### Using a Tripod with 0.64 cm (1/4 in.) Mounting Screws

To use a tripod with 0.64 cm (1/4 in.) mounting screws, first attach the supplied tripod adapter base to the camera and then attach the tripod to the adapter base.

- 1 Remove the original TB-1 tripod base from the camera.
  - Remove the 4 screws and then remove the base.
- 2 Attach the supplied tripod adapter base for 0.64 cm (1/4 in.) tripods.
  - Firmly screw in the 4 screws.
- 3 Attach the tripod.
  - Firmly screw in the tripod screw.

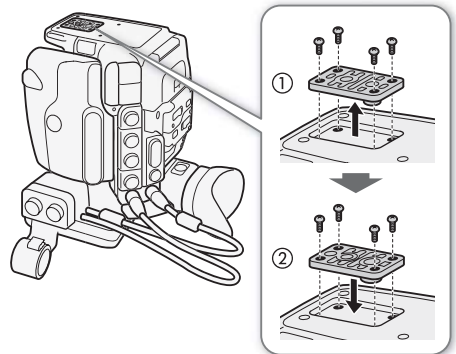

### Attaching the Handle Unit

- 1 Insert the attachment base at the bottom of the handle unit to the camera's accessory shoe.
- 2 Tighten the handle unit's lock screw while gently pressing it down.

#### **i** NOTES

- You can use the accessory shoe or the socket for 0.64 cm (1/4 in.) screws on the handle unit to attach a variety of commercially available accessories.

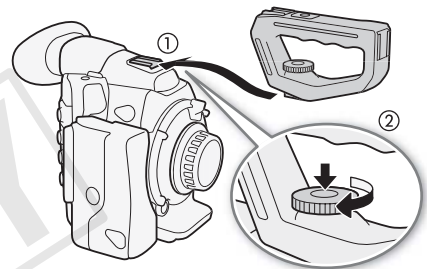

### Attaching a Shoulder Strap

Pass the ends through the strap mount and adjust the length of the strap.

#### **!** IMPORTANT

- Be careful not to drop the camera when attaching or adjusting the shoulder strap.

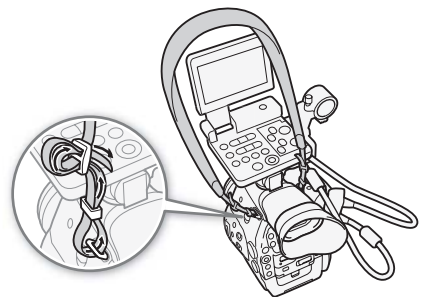

## Removing and Attaching the Terminal Covers

You can remove the plastic covers of the following terminals and SD card slot to access them more readily. For information on removing the MON./3G-SDI terminal cover, refer to *Connecting to a 4K- or 2K-Compatible External Recorder* (📖 41).

- EXT 1 and EXT 2
- SYNC OUT
- GENLOCK and TIME CODE
- HD/SD SDI
- CH1 and CH2  
(XLR terminals on the monitor unit)
- 🎧 (headphones)
- DC IN
- SD card slot
- REMOTE and HDMI OUT
- MIC
- WFT terminal
- GRIP terminal

### Removing the Terminal Covers

Open the terminal cover and gently pull it straight out.



### Attaching the Terminal Covers

Insert the connecting strip into the opening to attach the terminal cover.

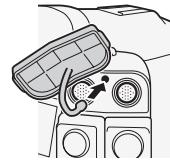

#### **i** NOTES

- If the connecting strip is difficult to grasp, use a pair of tweezers or similar tool.

COPY



## Connecting to a 4K- or 2K-Compatible External Recorder

When you use this camera to make 4K or 2K recordings, you must connect the camera to an external recorder\* using the 3G-SDI terminals. In addition to a video signal, the 3G-SDI terminals output an audio signal, time code signal, metadata and clip name information. Output from the 3G-SDI terminal is enabled by default but if it has been disabled, you must enable it after you connect the camera to the external recorder.

Refer also to the external recorder's instruction manual for details on how to record.

\* To make 4K recordings, the external recorder must be compatible with Canon RAW files. Refer to Canon's Web site for the latest information on compatible recorders.

Operating modes: CAMERA MEDIA | 4K 2K MXF

- 1 Unscrew the screw on the MON./3G-SDI terminal cover and pull the cover out.
- 2 Connect two commercially available BNC cables to the camera's 3G-SDI terminals and the external recorder.
  - Refer to the external recorder's instruction manual for details.
- 3 Open the [3G-SDI Output] submenu.
 

[ $\frac{4K}{2K}$  4K/2K/MXF Setup] ➤ [3G-SDI Output]
- 4 Select [On] and then press SET.

[ $\frac{4K}{2K}$  4K/2K/MXF Setup]

[3G-SDI Output]

[On]

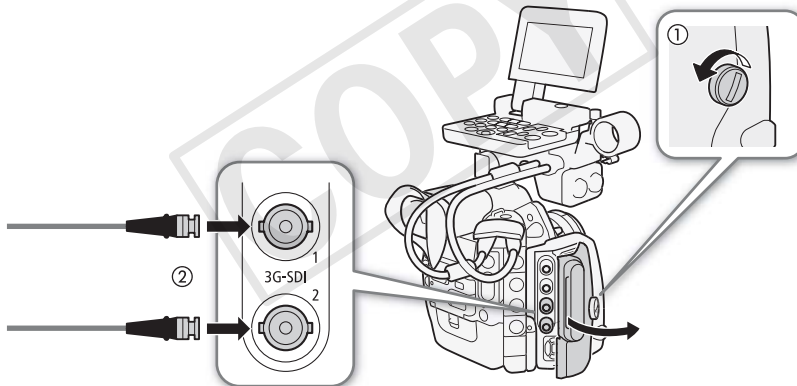

### ! IMPORTANT

- After you connect the camera to the external recorder, make a test recording first to check if they are operating correctly.

### i NOTES

- You can also remove the MON./3G-SDI terminal cover by sliding the screw toward the back of the camera and then pulling it outward along with the cover.
- If you do not intend to use the 3G-SDI terminals in other situations, set the camera to MXF mode (☰ 64) and then close the MON./3G-SDI terminal cover in order to conserve the camera's power. When you do so, the camera can record only in MXF mode.
- You can use the [▶ Camera Setup] ➤ [Color Space] setting to configure the color space of the video output from the 3G-SDI terminal and MON. terminals to DCI-P3+ or Cinema Gamut. When checking the output, you will need a display device that is compatible with each color space.

### Video signal output from the 3G-SDI terminals

The following summarizes the video signal output from the 3G-SDI terminals for general shooting situations. The figures in parentheses apply to 2K mode.

| Video configuration (📖 60)   |            | Output signal                                |  |
|--|------------|--|--|
| System priority / Recording mode                                   | Frame rate | 3G-SDI 1 terminal                            | 3G-SDI 2 terminal                            |
| 4K / RAW<br>2K / <b>RGB444</b> 12-bit<br>2K / <b>RGB444</b> 10-bit | 59.94P     | 29.97P <sup>1</sup>                          | 29.97P <sup>1</sup>                          |
|  | 29.97P     | 29.97P <sup>2</sup>                          | 29.97P <sup>2</sup>                          |
|  | 23.98P     | 23.98P <sup>2</sup>                          | 23.98P <sup>2</sup>                          |
|  | 50.00P     | 25.00P <sup>1</sup>                          | 25.00P <sup>1</sup>                          |
|  | 25.00P     | 25.00P <sup>2</sup>                          | 25.00P <sup>2</sup>                          |
|  | 24.00P     | 24.00P <sup>2</sup>                          | 24.00P <sup>2</sup>                          |
| 4K / HRAW<br>4K / 4K1K RAW<br>2K / <b>YCC422</b> 10-bit            | 59.94P     | 29.97PsF <sup>2</sup> (59.94P <sup>2</sup> ) | 29.97PsF <sup>2</sup> (59.94P <sup>2</sup> ) |
|  | 50.00P     | 25.00PsF <sup>2</sup> (50.00P <sup>2</sup> ) | 25.00PsF <sup>2</sup> (50.00P <sup>2</sup> ) |

<sup>1</sup> Both 3G-SDI 1 terminal and 3G-SDI 2 terminal are required. The output from each terminal differs by one frame.

<sup>2</sup> The signals output from 3G-SDI 1 terminal and 3G-SDI 2 terminal are the same.

The following summarizes the video signal output from the 3G-SDI terminals for slow & fast motion mode.

| Video configuration  |                      |                                 | Output signal           |                       |
|--|----------------------|---------------------------------|-------------------------|-----------------------|
| System priority / Recording mode                                   | System frequency     | Frame rate (slow & fast motion) | 3G-SDI 1 terminal       | 3G-SDI 2 terminal     |
| 4K / RAW<br>2K / <b>RGB444</b> 12-bit<br>2K / <b>RGB444</b> 10-bit | 59.94 Hz<br>24.00 Hz | 1 to 30                         | 1 to 30P <sup>2</sup>   | 1 to 30P <sup>2</sup> |
|  |                      | 32 to 60 <sup>1</sup>           | 32 to 60P <sup>3</sup>  |                       |
|  | 50.00 Hz             | 1 to 25                         | 1 to 25P <sup>2</sup>   | 1 to 25P <sup>2</sup> |
|  |                      | 26 to 50 <sup>1</sup>           | 26 to 50P <sup>3</sup>  |                       |
| 4K / HRAW<br>4K / 4K1K RAW<br>2K / <b>YCC422</b> 10-bit            | 59.94 Hz<br>24.00 Hz | 1 to 60                         | 1 to 60P <sup>2</sup>   | 1 to 60P <sup>2</sup> |
|  |                      | 62 to 120 <sup>1</sup>          | 62 to 120P <sup>3</sup> |                       |
|  | 50.00 Hz             | 1 to 50                         | 1 to 50P <sup>2</sup>   | 1 to 50P <sup>2</sup> |
|  |                      | 52 to 100 <sup>1</sup>          | 52 to 100P <sup>3</sup> |                       |

<sup>1</sup> When the shooting frame rate is enclosed by brackets on the screen, this indicates that both 3G-SDI terminals are necessary to record the 3G-SDI output signal using an external recorder.





<sup>2</sup> The signals output from 3G-SDI 1 terminal and 3G-SDI 2 terminal are the same.

<sup>3</sup> Both 3G-SDI terminals combine to output this signal.

### NOTES

- Depending on the external recorder, you may not be able to record at the desired video configuration.

## Preparing Recording Media

The camera records MXF clips to  CompactFlash (CF) cards and photos\* to  SD and  SDHC memory cards. The camera is equipped with two CF card slots. Initialize recording media ( 45) when you use them with this camera for the first time.

\* The camera can record custom picture files and a camera settings file onto the SD card as well. The SD card serves also to store user memo files created with the supplied software **Canon XF Utility** that you can then read and embed in the clips' metadata.

### Compatible CF cards

You can use UDMA-compatible\* Type I CF cards with a capacity of at least 512 MB with the camera. For more details on cards that can be used, visit your local Canon Web site.

\* The Ultra Direct Memory Access (UDMA) specification allows data to be transferred between the CF card and device at high transfer speeds (measured in MB/s). Depending on the CF card, you may not be able to record even when using a UDMA-compatible CF card.

### NOTES

- Proper operation cannot be guaranteed for all CF cards.

### Inserting a CF Card

You can insert a CF card into CF card slot A or slot B. If you have two CF cards, you can use both slots.

- 1 Slide the CF card slot cover switch in the direction of the arrow.
  - The CF card slot cover will open upward (slot A) or downward (slot B).
- 2 Insert the CF card straight, with the label facing up, all the way into the slot.
- 3 Close the CF card slot cover.
  - Do not force the cover closed if the CF card is not correctly inserted.

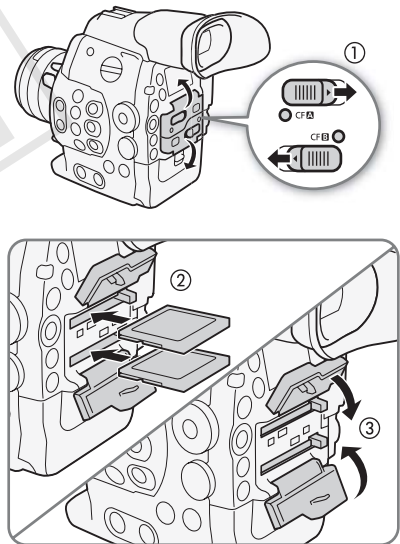

### Checking the Status of the CF Card Slots

You can check the status of the CF card slots immediately by looking at the CF **A**/CF **B** access indicator. Refer to the following table.

| Access indicator color | CF card slot status  |
|------------------------|--|
| Red                    | Accessing CF card.   |
| Green                  | Recording/playback is possible and the CF card slot is selected for recording/playback.                      |
| Indicator off          | A CF card is not inserted, the CF card slot is not currently selected, or the CF card is not being accessed. |

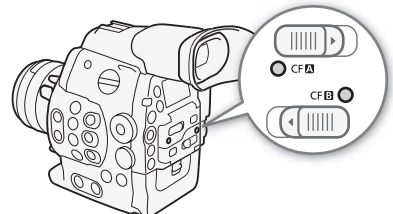

## Removing a CF card

- 1 Wait until the access indicator for the card slot with the CF card to be removed is off.
- 2 Slide the CF card slot cover switch in the direction of the arrow.
  - The CF card slot cover will open upward (slot A) or downward (slot B).
- 3 Push the CF card release button.
  - The release button partially pops out.
- 4 Push in the CF card release button to release the CF card.
- 5 Pull the CF card all the way out and close the CF card slot cover.

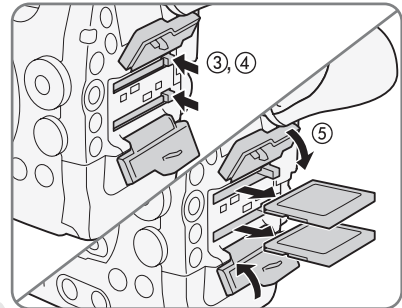
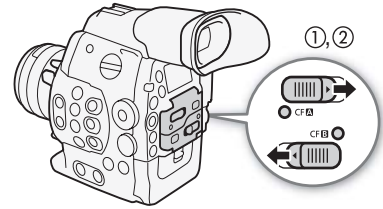

### ! IMPORTANT

- Observe the following precautions while the CF **A** or CF **B** access indicator is illuminated in red. Failure to do so may result in permanent data loss.
  - Do not disconnect the power source or turn off the camera.
  - Do not open the cover of the CF card slot being accessed.

### i NOTES

- If you set the [Other Functions] [Media Access LED] function to [Off], the access indicators will not illuminate.

## Inserting and Removing an SD Card

- 1 Turn off the camera.
- 2 Open the SD card slot cover.
- 3 Insert the SD card all the way into the SD card slot until it clicks.
  - The SD card slot is positioned at an angle. Align the SD card straight in relation to the SD card slot, with the label facing the lens.
- 4 Close the SD card slot cover.
  - Do not force the cover closed if the SD card is not correctly inserted.

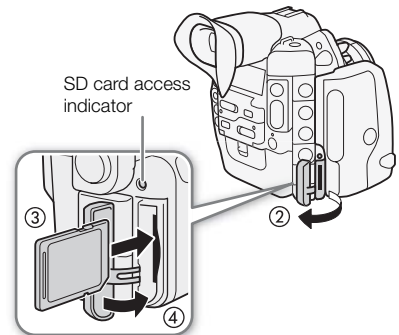

### ! IMPORTANT

- Observe the following precautions while the SD card access indicator is flashing. Failure to do so may result in permanent data loss.
  - Do not disconnect the power source or turn off the camera.
  - Do not remove the SD card.
- Turn off the camera before inserting or removing an SD card. Inserting or removing the SD card with the camera on may result in permanent data loss.
- SD cards have front and back sides that are not interchangeable. Inserting an SD card facing the wrong direction can cause a malfunction of the camera. Be sure to insert the SD card as described in step 3.

### i NOTES

- **To remove the SD card:** Push the SD card once to release it. When the SD card springs out, pull it all the way out.

- If you set the [👉 Other Functions] ➡ [Media Access LED] function to [Off], the access indicators will not illuminate.

## Initializing the Recording Media

The first time you use any recording media with this camera, initialize it first. You can also initialize a recording media to permanently delete all the data it contains.

When initializing an SD card, you can select quick initialization, which clears the file allocation table but does not physically erase the stored data, or complete initialization, which deletes all data completely.

Operating modes: CAMERA MEDIA | 4K 2K MXF

1 Open the [Initialize Media] submenu.

[👉 Other Functions] ➡ [Initialize Media]

[👉 Other Functions]

2 Select [CF A], [CF B] or [SD Card] and then press SET.

[Initialize Media]

To initialize a CF card

3 Select [OK] and then press SET.

4 When the confirmation message appears, press SET.

- The CF card is initialized and all the data it contains is erased.

To initialize an SD card

3 Select [Complete] (complete initialization) or [Quick] (quick initialization) and then press SET.

4 Select [OK] and then press SET.

- If you are using the [Complete] initialization option, press SET twice to cancel the operation while it is in progress. You can use the SD card but all data will be erased.

5 When the confirmation message appears, press SET.

- The SD card is initialized and all the data it contains is erased.

### ! IMPORTANT

- Initializing a recording media will permanently erase all data, including clips with an **OK** mark, protected photos, and custom picture files. Lost data cannot be recovered. Make sure you save important recordings in advance.
- Depending on the SD card, the complete initialization may take up to a few minutes.

### i NOTES

- While recording on a CF card, you can initialize another CF card in the other CF card slot.
- If you set an assignable button to [Initialize Media] (📖 111), you can press the button to open the initialization submenu.

## Switching Between the CF Card Slots

The camera features two CF card slots, CF **A** (CF card slot A) and CF **B** (CF card slot B). If both slots contain a CF card, you can switch between them as necessary.

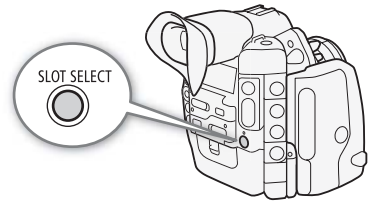

Operating modes: CAMERA MEDIA | 4K 2K MXF

Press the SLOT SELECT button.

- The access indicator of the selected CF card slot will illuminate in green. On the screen, the CF card selected is indicated with a ► mark next to the CF card icon and in the rear panel, with a ▼ mark on top of the CF card icon.

### **i** NOTES

- If both CF card slots contain a CF card and you open the cover of the selected slot, the camera will automatically switch to the other slot.
- You cannot use the SLOT SELECT button to switch between CF card slots while recording.
- When using an optional WFT-E6 Wireless File Transmitter, you can also switch between CF card slots remotely by pressing [SLOT SELECT] on the Wi-Fi Remote screen.



## Selecting the CF Card Recording Method

The camera features two useful CF card recording methods, relay recording and double slot recording.

Relay recording: This function allows you to continue recording on another CF card without interruption if the CF card you are using becomes full. Relay recording is available from CF card slot A to CF card slot B, and vice versa.

Double slot recording: This function records the same clip simultaneously to both CF cards, which is a convenient way to make a backup copy of your recording while you record.

Operating modes: CAMERA MEDIA | 4K 2K MXF

### To use relay recording

By default, this function is activated. If it has been deactivated, follow the procedure below to activate it.

- 1 Open the [Relay Rec] submenu.  
 [4K/2K 4K/2K/MXF Setup] ► [Set CF Card Slot] ► [Relay Rec]
- 2 Select [On] and then press SET.

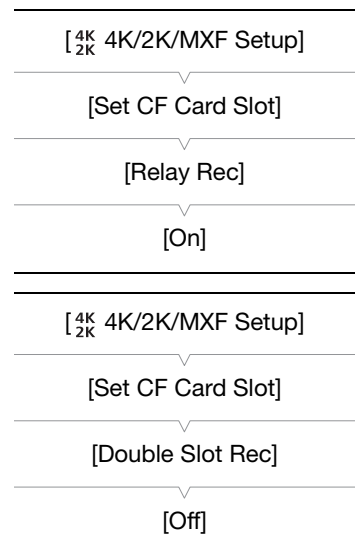

### To use double slot recording

- 1 Open the [Double Slot Rec] submenu.  
 [4K/2K 4K/2K/MXF Setup] ► [Set CF Card Slot] ► [Double Slot Rec]
- 2 Select [On] and then press SET.

### **i** NOTES

- When the bit rate is set to 50 Mbps (60), relay recording is not available during slow motion recording.

- If a CF card becomes full during double slot recording, recording on both cards will stop. On the other hand, if an error occurs with one of the cards, recording will continue on the other card.
- Double slot recording cannot be used with relay recording or slow & fast motion recording.

## Checking the Available Recording Time for CF Cards

When the camera is in **CAMERA** mode, the display on the upper left of the screen indicates which CF card slot is in use and the available recording time (in minutes\*) that remains on each CF card. The same information is displayed in the rear panel. When the camera is in **MEDIA** mode, the available recording time is displayed only in the rear panel.

On the [Media] status screen (☰ 183), you can check the total space and used space of each recording media, as well as the available recording time\* on each CF card and the available number of photos on the SD card.

\* The approximate available recording time is based on the current bit rate (☰ 60).

## Recovering Data on the CF Card

Some actions, such as suddenly turning off the camera or removing the CF card while data is being recorded, can cause data errors on the CF card. In such case, you may be able to recover the data on the CF card.

Operating modes: **CAMERA** **MEDIA** | **4K** **2K** **MXF**

- 1 Insert the CF card with the data to be recovered into the camera.
- 2 When the screen prompts you to recover the data, select **[OK]** and then press **SET**.
- 3 When the confirmation message appears, press **SET**.

### **i** NOTES

- This procedure will delete clips shorter than 10 seconds in length. Additionally, up to 10 seconds will be deleted from the end of clips on the CF card.
- In some cases, data may not be recovered, such as when the FAT32 file system is corrupted or the CF card is physically damaged.
- While recording on a CF card, you can recover data from another CF card by inserting it into the other CF card slot.

## Adjusting the Black Balance

You can have the camera adjust the black balance automatically when ambient temperature changes considerably or if there is a noticeable change in a true black video signal.

Operating modes: CAMERA MEDIA | 4K 2K MXF

1 Open the [ABB] screen.

[Camera Setup] ➤ [ABB]

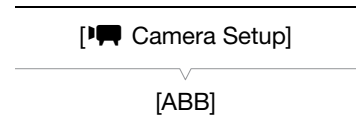

2 Attach the body cap to the lens mount.

- If a lens was attached, remove the lens and replace the body cap.

3 Select [OK] and then press SET.

- The automatic black balance procedure will start.

4 When the confirmation message appears, press SET.

- If the body cap is not correctly attached, [Error] will appear on the screen. Press SET and repeat the procedure from the beginning.

### NOTES

- Adjusting the black balance may be necessary in the following cases:
  - When using the camera for the very first time or after a long period of not using it.
  - After sudden or extreme changes in ambient temperature.
  - After changing the ISO speed/gain settings.
- The automatic black balance procedure will take approximately 40 seconds when the frame rate is set to 23.98P or 24.00P.
- During the adjustment of the black balance, you may notice some irregular displays appear on the screen. This is not a malfunction.
- Resetting the camera's settings using the [ Other Functions] ➤ [Reset] ➤ [All Settings] or [Camera Settings] menu option will reset also the black balance adjustment. In such case, perform the procedure again.



## Remote Operation Via the Wi-Fi Remote Application

You can attach an optional WFT-E6 Wireless File Transmitter to the camera and operate the camera remotely via Wi-Fi Remote, a Web browser application that can be accessed using the Web browser on any device compatible with Wi-Fi networks\*. The Wi-Fi Remote application lets you monitor the image through live view, start and stop recording and remotely control the shutter speed, ISO speed/gain and other settings. You can also create, edit and transfer a metadata profile, set various shot marks and check the recording media, remaining recording time, time code, etc.

\* For details about compatible devices, operating systems, Web browsers, etc. please visit your local Canon Web site.

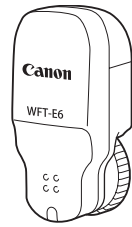

49

Operating modes: CAMERA MEDIA | 4K 2K MXF



### Preparing the System for Wi-Fi Remote

To be able to operate the camera remotely via the Wi-Fi Remote application you will need to attach an optional WFT-E6 Wireless File Transmitter to the camera's WFT terminal and complete the wireless network setup. Download 'WFT-E6 Wireless File Transmitter - Guide for Canon Camcorders' (PDF file) from your local Canon Web site and follow the instructions to complete the necessary setup.

COPY

## Recording Video

This section explains the recording basics. Before you use an external recorder, make sure it is operating correctly. Before you begin recording on a CF card, make a test recording first to check if the camera is operating correctly. Record for approximately 6 minutes at 50 Mbps (📖 60). Should the camera fail to operate correctly, refer to *Troubleshooting* (📖 187).

For details on recording audio, refer to *Recording Audio* (📖 92).

Operating modes: CAMERA MEDIA | 4K 2K MXF

### Preparing to Record

- 1 Attach the monitor unit, handle unit, etc. as necessary to build the desired configuration (📖 32).
- 2 Attach a charged battery pack to the camera (📖 24).
- 3 For MXF recordings, insert a CF card into a CF card slot (📖 43).
  - Insert another CF card into the other CF card slot to use relay recording (📖 46) or double slot recording (📖 46).
- 4 Attach a lens (📖 33, 35).
- 5 To make 4K and 2K recordings, connect the camera to an external recorder (📖 41).
- 6 Adjust the viewfinder.

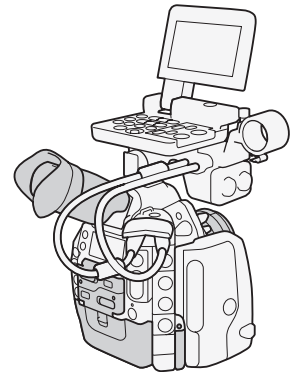

### **i** NOTES

- The camera can add a user memo (📖 97) to an MXF clip as you record. It can be used to store information such as the clip name, camera operator and filming location. However, you must set the user memo before recording.

### Recording

- 1 Set the **POWER** switch to **CAMERA** (📖 26).
  - The camera turns on in CAMERA mode and enters record pause mode.
  - When a CF card is in the camera, the access indicator for the CF card slot selected for recording illuminates in red and then changes to green.
- 2 Open the [System Priority] submenu.
 

[4K/2K 4K/2K/MXF Setup] ➤ [System Priority]

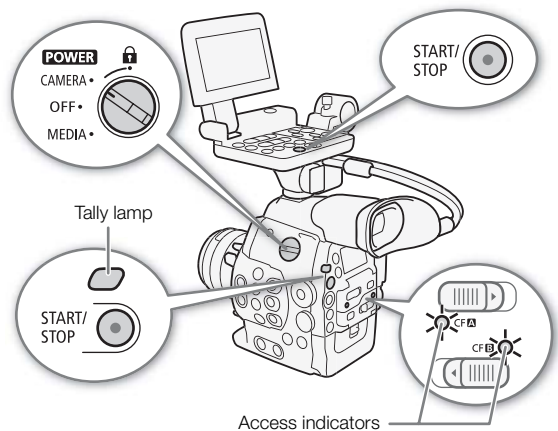

### 3 Select [4K], [2K] or [MXF] and then press SET.

- The system priority changes to the selected menu item. Hereafter, each mode will be referred to in this manual as “4K mode”, “2K mode” and “MXF mode”, respectively.
- Select [4K] or [2K] to record a 4K or 2K clip\* on an external recorder. Select [MXF] to record only an MXF clip (HD video) on a CF card.
- During 4K mode, [RAW] appears on the upper right of the screen and the **RAW** icon appears on the rear panel.

\* “Clip” refers to one movie unit from the point you press the START/STOP button to start recording until you press again to pause the recording. You can also include custom picture settings (☞ 114) and metadata (☞ 97) with MXF clips.

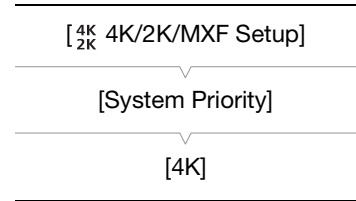

### 4 Press the START/STOP button to begin recording.

#### • During 4K and 2K modes:

- Recording starts and a signal is sent to an external recorder connected to the HD/SD SDI or 3G-SDI terminals instructing it to start recording. [●REC ➔] appears at the upper center of the screen and the tally lamp illuminates.
- If there is a CF card in a CF card slot, the camera simultaneously records an MXF clip on the card. In such case, [●REC] appears on the upper left of the screen.
- Depending on the aspect ratio of the 4K or 2K video, you can select the resizing method when recordings on the CF card are output (☞ 63).

#### • During MXF mode:

- Recording starts. The tally lamp illuminates and [●REC] appears on the upper center of the screen.
- If an external recorder is connected to the HD/SD SDI terminal, a signal is sent instructing it to start recording. [●REC ➔] appears on the center right of the screen.

- You can use the START/STOP button on the back of the camera, the front of the camera (next to the lens mount), or the monitor unit.

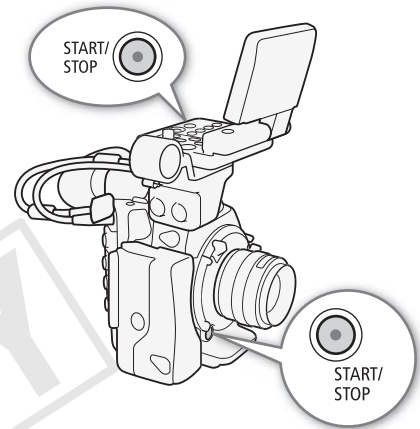

### 5 Press the START/STOP button to pause the recording.

- Recording stops and a signal is sent to the external recorder to pause the recording. When recording on a CF card, a clip is recorded and the camera enters record pause mode. [STBY ➔] or [STBY] appears at the top of the screen. The tally lamp will also go out.

### Locking the Controls in Recording Mode

Once in **CAMERA** mode, you can set the **POWER** switch to **🔒** (key lock) to lock all the physical controls (buttons and switches) on the camera\*, save for the START/STOP button. With the [Other Functions] [Custom Function] [START/STOP] setting, you can even choose to lock all buttons, including the START/STOP button. In such case, you can use Wi-Fi Remote to operate the camera. This is useful in preventing settings from being changed due to inadvertently pressing one of the buttons. Return the **POWER** switch to the CAMERA position to reactivate the controls.

\* The Wi-Fi Remote application also has a key lock function that is limited only to the controls on the application's screens (you will still be able to use the controls on the camera). Press **🔒** to lock the application's controls; press **🔒** to reactivate them.

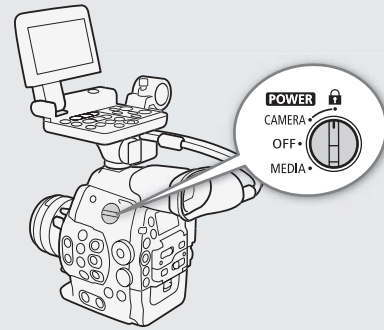

### About Clips

When the camera records an MXF clip, it also assigns a 6-character clip name consisting of a 2-character prefix (letters or numerals) and 4 numerals (for example, "AA0001"). The last 4 numbers serve as a running counter that increases every time a clip is recorded. You can set the initial clip name in advance using the [4K/2K/MXF Setup] [Clip Name] [Title Prefix] and [Number Setting] settings. You cannot change the clip name after the clip is recorded.

In 4K and 2K modes, the clip name is included with the video signal that is output from the 3G-SDI terminals. If you use the software **Cinema RAW Development** to develop RAW clips recorded with an external recorder and export them, MXF clips recorded on a CF card and the exported files can be given similar names to make post-production more efficient. In the following cases, the clip name is not sent to the external recorder.

- During MXF mode.
- When the CF card in the camera cannot be recorded on, does not have enough available space or has an access error.
- During 4K and 2K modes, when using the interval recording, frame recording or slow & fast motion recording modes.

### NOTES

- When recording MXF clips, the following apply.
  - If you are recording with two CF cards and the CF card you are using becomes full while recording, the clip will continue uninterrupted on the other CF card when relay recording (46) is activated. In such case, the recording will be recorded as separate clips.
  - If you record using the custom picture and metadata settings, those settings will be recorded with the clip. For more details, refer to *Custom Picture Settings* (114) and *Using Metadata* (97).
  - The video (stream) file in a clip will be split approximately every 2 GB for clips with a long recording time (approximately every 1 GB during slow motion recording). Even in such case, playback will be continuous.

### IMPORTANT

- Observe the following precautions while the CF **A** or CF **B** access indicator is illuminated in red. Failure to do so may result in permanent data loss.
  - Do not open the CF card slot cover of the CF card slot being accessed and remove the CF card.
  - Do not disconnect the power source or turn off the camera.
- Be sure to save your recordings regularly (153), especially after making important recordings. Canon shall not be liable for any loss or corruption of data.

### NOTES

- By default, [4K/2K/MXF Setup] [Rec Command] is set to [On]. With this function, when you connect the camera to another device using the 3G-SDI terminals (in 4K and 2K modes) or HD/SD SDI terminal (in MXF mode), if you start or stop recording with the camera, the other device will also start or stop recording.

- By default, [Other Functions] [Fan] is set to [Automatic] and the internal cooling fan will be activated during record pause mode. While recording, when the camera's internal temperature goes below a predetermined level, the cooling fan will deactivate. You can also set the cooling fan to be activated at all times.
- When recording MXF clips, the following apply.
  - You can use [Other Functions] [Rec Review] (104) to review part or all of the last clip recorded.
  - If you set an assignable button to [Add OK Mark] or [Add Mark] (111), you can press the button to add an OK mark or Mark to the last clip recorded.
  - You can use [Other Functions] [Delete Last Clip] (177) to delete the last clip recorded. However, you cannot delete the last clip if double slot recording is on.

## Remote Operation Using Wi-Fi Remote

After completing the necessary preparations (49) you can start and stop recording from a Wi-Fi-enabled device using the Wi-Fi Remote application.

1 Press [LIVE VIEW ON/OFF] to show the camera's live view image on the Wi-Fi Remote screen.

2 Press [START/STOP] to begin recording.

- The recording operation indicator changes from [STBY] to [REC], the center of the START/STOP button lights up in red and the time code display starts running on the Wi-Fi Remote screen.
- Press [START/STOP] again to pause the recording.



## Onscreen Displays

Refer to this section for an explanation of the various screen displays that appear in **CAMERA** mode. You can use the custom display function (☰ 123) to turn off individual onscreen displays if they are not required.

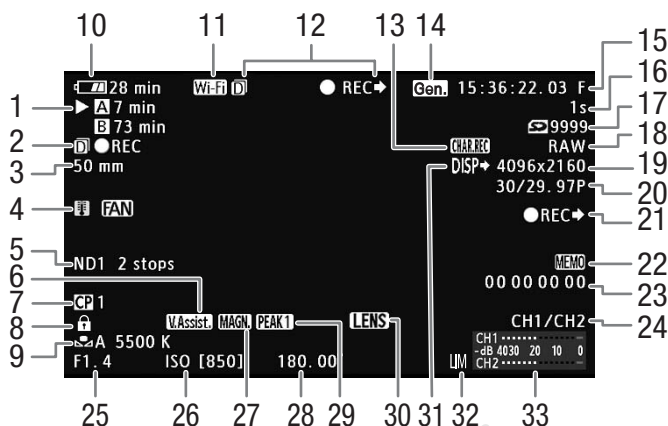

When displaying the date and time (☰ 28):





- |  |   |
|--|---|
| 1 CF card status/available recording time (☰ 56)   | 16 Interval counter (☰ 105)   |
| 2 During 4K and 2K modes: CF card recording operation (☰ 63)<br>During MXF mode: Remaining recording time for double slot recording (☰ 46) | 17 Available number of photos   |
| 3 <b>C500</b> Current focal length of an attached EF lens <sup>1</sup>   | 18 Recording mode (☰ 60)/Bit rate (☰ 64)  |
| 4 Temperature warning / Fan  | 19 Resolution (☰ 62, 64)  |
| 5 ND filter (☰ 73)   | 20 Frame rate (shooting frame rate <sup>3</sup> during slow & fast motion mode) (☰ 60, 108) |
| 6 View assistance (☰ 58)   | 21 During MXF mode: Recording command status (☰ 172)  |
| 7 Custom picture (☰ 114)   | 22 User memo (☰ 97)   |
| 8 Key lock (☰ 53)  | 23 User bit (☰ 87)  |
| 9 White balance (☰ 76)   | 24 Audio output channel (☰ 96)  |
| 10 Remaining battery time (☰ 56)   | 25 <b>C500</b> Aperture value (☰ 74)  |
| 11 Wi-Fi <sup>2</sup> (☰ 49) white - connected to a Wi-Fi network; yellow - connecting to or disconnecting from a Wi-Fi network.           | 26 ISO speed/Gain (☰ 70)  |
| 12 During 4K and 2K modes: Recording command status<br>During MXF mode: Recording operation (☰ 56)   | 27 Magnification (☰ 80)   |
| 13 Character recording (☰ 122)   | 28 Shutter angle (☰ 67)   |
| 14 Genlock (☰ 88)  | 29 Peaking (☰ 80)   |
| 15 Time code (☰ 84)  | 30 Lens warning (☰ 175)   |
|  | 31 Output displays (☰ 149)  |
|  | 32 Audio peak limiter (☰ 94)  |
|  | 33 Audio level meter (☰ 94, 95)   |
|  | 34 Date/time (☰ 28)   |

<sup>1</sup> The displayed value is an estimate.

<sup>2</sup> Only when an optional WFT-E6 Wireless File Transmitter is connected to the camera.

<sup>3</sup> During 4K and 2K modes, when the shooting frame rate is enclosed by brackets, this indicates that both 3G-SDI terminals are necessary to record the 3G-SDI output signal on an external recorder.

## NOTES

- You can press the DISP. button to switch the onscreen displays in the following sequence.  
Show all onscreen displays → show only onscreen markers\* → hide all onscreen displays.  
\* Only when the  [LCD/VF Setup]  [Markers] setting is enabled.

### 1 CF card status/available recording time



- The following indicates the CF card status.

 Can record on CF card







 No CF card or cannot record on CF card

The CF card selected for recording is indicated with a  mark.











### 2 CF card recording operation (4K and 2K modes)



- When double slot recording ( 46) is activated, the  icon will appear to the left of the operation indicator.

### 10 Remaining battery time

- The icon shows a rough estimate of the remaining charge as a percentage of the full charge of the battery pack. The remaining recording/playback time of the battery pack is displayed, in minutes, next to the icon.
-  →  →  →  →  (in red).  
When  is displayed, replace the battery pack with a fully charged one.
- Depending on the conditions under which the camera and the battery pack are used, the actual battery charge may not be indicated accurately.

### 12 Recording command status (4K and 2K modes) / Recording operation (MXF mode)

-  Recording
-  Record pause
-  Interval recording
-  Interval record pause
-  Frame recording
-  Frame record pause (after starting recording)
-  Frame record pause (before starting recording)
-  Slow & fast motion recording
-  Slow & fast motion record pause
-  Pre-recording (after pressing the START/STOP button)
-  Pre-recording (before pressing the START/STOP button)

- In MXF mode, when double slot recording ( 46) is activated, the  icon will appear to the left of the operation indicator. Also,  does not appear in the indicator.
- Pre-recording is available only during MXF mode.



## Rear Panel Displays

You can check the following information on the rear panel. This allows you to easily adjust main camera functions like the shutter speed, white balance and ISO speed/gain even when the monitor unit is not attached to the camera without having to use the viewfinder.

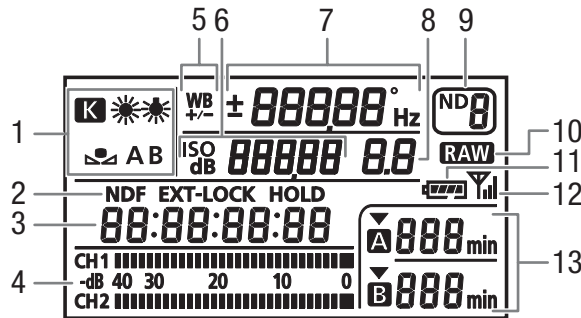

- |   |   |
|---|---|
| 1 White balance ( 76)   | 8 <b>C500</b> Aperture value ( 74)                          |
| 2 Time code settings: NDF Non-drop frame ( 85) / EXT-LOCK External time code signal locked ( 89) / HOLD Time code display on hold ( 85) | 9 ND filter ( 73)   |
| 3 Time code ( 84)   | 10 RAW output ( 60)   |
| 4 Audio level meter <sup>1</sup> ( 94, 95)  | 11 Approximate remaining battery time <sup>1</sup>          |
| 5 White balance fine-tuning ( 76)   | 12 Wi-Fi <sup>4</sup> ( 49)                                 |
| 6 <b>250</b> ISO speed/ <b>6.0</b> Gain ( 70)   | 13 CF card status and available recording time <sup>1</sup> |
| 7 Shutter speed ( 67)/White balance   |   |
| <b>100</b> Shutter speed <sup>2</sup> (mode set to [Speed], [Slow] or [Off])  |   |
| <b>18000°</b> Shutter speed (mode set to [Angle])   |   |
| <b>5994 Hz</b> Shutter speed (mode set to [Clear Scan])   |   |
| <b>±0</b> White balance fine-tuning <sup>3</sup> ( 76)  |   |
| <b>5500</b> White balance, color temperature <sup>3</sup> ( 77)   |   |

<sup>1</sup> Displayed also in **[MEDIA]** mode.

<sup>2</sup> In these shutter speed modes, only the denominator is displayed - **100** indicates a shutter speed of 1/100, etc.

<sup>3</sup> Only displayed while adjusting the setting.

<sup>4</sup> Only when an optional WFT-E6 Wireless File Transmitter is connected to the camera.

### Adjusting the Brightness of the Rear Panel

Repeatedly pressing the  (backlight) button will change the brightness of the rear panel in the following order: Backlight on (bright) → Backlight on (dim) → Backlight off.

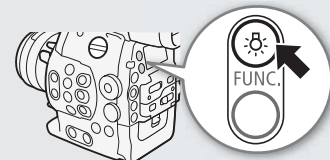

## Canon Log Gamma and CINEMA Preset

The Canon Log gamma setting makes full use of the newly developed image sensor to offer spectacular dynamic range.

You can easily set the camcorder to use a number of preset picture-related settings especially designed with professional cinematography and motion picture production in mind. With the CINEMA preset settings, the gamma and color matrix (📖 117) will be set to the advanced Canon Log setting, which makes full use of the newly developed image sensor to offer spectacular dynamic range. On the other hand, other custom picture settings will not be available.

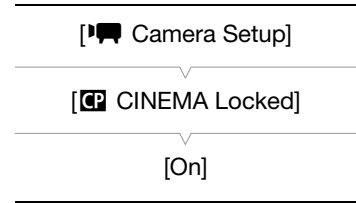

| System priority | Output terminal/<br>Recording destination | [CINEMA Locked] setting          | Picture setting                               |
|-----------------|---|----------------------------------|---|
| 4K<br>2K        | 3G-SDI terminals                          | –                                | Canon Log gamma                               |
|                 | MON. terminals                            | –                                | Canon Log gamma with or without a LUT applied |
|                 | CF card                                   | [On]                             | CINEMA preset settings with Canon Log gamma   |
| [Off]           |   | Based on custom picture settings |   |
| MXF             | CF card                                   | [On]                             | CINEMA preset settings with Canon Log gamma   |
|                 |   | [Off]                            | Based on custom picture settings              |

Clips recorded using Canon Log gamma need to be processed in post-production. During post-production, you can apply a LUT (lookup table) to clips recorded using Canon Log gamma to view the clips with more natural colors. For details about available LUTs, visit your local Canon Web site.

\* You can also apply a LUT to the MON. terminal or HD/SD SDI terminal output.

### Setting CINEMA Preset

1 Open the [CINEMA Locked] submenu.

[Camera Setup] ➤ [CINEMA Locked]

2 Select [On] and then press SET.

- All picture-related settings will be set according to the CINEMA preset values. As such, you will not be able to adjust custom picture settings.
- [LOCKED] appears on the left of the screen.

### Checking Clips Recorded with Canon Log Gamma (View Assistance)

When Canon Log gamma is used, the image displayed on the screen will appear darker than usual. When you are shooting with Canon Log gamma and are checking the picture on an external monitor connected to a MON. terminal or the HD/SD SDI you can apply a LUT to the output (📖 146). In addition, you can use the view assistance function to display an image that approximates the one that would be obtained using normal gamma settings. View assistance is only applied on the camera screen; it will not affect your recordings or the video signal output from the various terminals.

1 Open the [View Assist.] submenu.

[LCD/VF Setup] ➤ [View Assist.]

2 Select [On] and then press SET.

- [V.Assist.] will appear on the lower left of the screen.

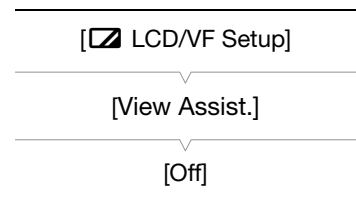

### NOTES

- If you set an assignable button to [View Assist.] (📖 111), you can press the button to enable the view assistance function.

## Using the Internal Cooling Fan

During **CAMERA** mode, the camera uses an internal cooling fan to reduce the camera's internal heat.

Operating modes: **CAMERA** **MEDIA**

1 Open the [Fan] submenu.

[ Other Functions]  [Fan]

2 Select the desired option and then press SET.

### Options

[On]: The cooling fan is active at all times regardless of the camera's internal temperature.

[Automatic]: During record pause mode, the cooling fan is always activated. While you are recording (while [ REC] appears on the screen), if the camera's internal temperature lowers to a predetermined level, the cooling fan will deactivate. If the camera's internal temperature rises to a predetermined level, the cooling fan will activate automatically (**FAN** will appear on the screen), even while you are recording.

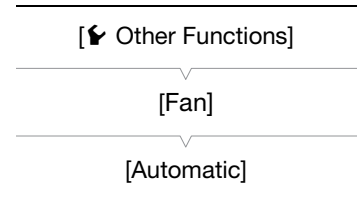

### NOTES

- While the cooling fan is set to [Automatic], when you start the camera in a cooled down state and shoot in 4K or 2K mode, the cooling fan will activate in approximately 10 minutes, based on a surrounding temperature of 25 °C (77 °F). Also, depending on the surrounding temperature, the cooling fan may stop after a short period of time or continue to operate.

## Video Configuration: Type of Recording, Resolution and Frame Rate

Before you shoot, select the type of recording, resolution (frame size), frame rate and other settings that best match your creative needs. The options available will depend on whether the camera is in 4K mode, 2K mode or MXF mode, as well as the system frequency setting.

### Selecting the Video Configuration for 4K and 2K Modes

To set the video configuration, select the system frequency, system priority, recording mode, resolution, and frame rate, as necessary. For a summary of the video configuration, refer to the table following the procedures below.

Operating modes: CAMERA MEDIA | 4K 2K MXF

#### Selecting the System Priority

When you select the system priority, you can have the camera output 4K or 2K image data.

- 1 Open the [System Priority] submenu.  
[<sup>4K</sup>/<sub>2K</sub> 4K/2K/MXF Setup] ➤ [System Priority]
- 2 Select [4K] or [2K] and then press SET.
  - The camera will switch to the selected mode. If the camera was in MXF mode, it will restart in the selected mode.

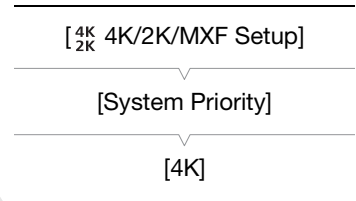

#### Selecting the System Frequency

- 1 Open the [System Frequency] submenu.  
[<sup>4K</sup>/<sub>2K</sub> 4K/2K/MXF Setup] ➤ [System Frequency]
- 2 Select the desired option and then press SET.
  - The camera will restart in the selected mode.
  - In this manual, recordings with a system frequency of 59.94 Hz, 50.00 Hz and 24.00 Hz are referred to as 59.94 Hz recordings, 50.00 Hz recordings and 24.00 Hz recordings, respectively.

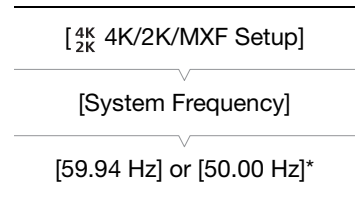

\* Depending on the country/region of purchase.

#### Selecting the Recording Mode

For 4K mode, the recording mode determines whether the vertical resolution is 2160 pixels (RAW) or 1080 pixels (HRAW or 4K1K RAW). For 2K mode, it determines the color sampling and bit depth.

- 1 Open the [Mode] submenu.  
[<sup>4K</sup>/<sub>2K</sub> 4K/2K/MXF Setup] ➤ [4K (4096/3840)] or [2K (2048/1920)] ➤ [Mode]

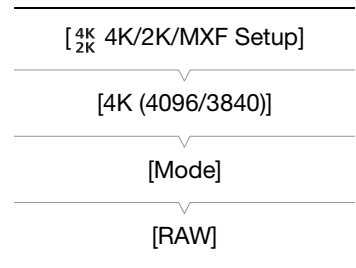

2 Select the desired recording mode and then press SET.

Available recording modes by system priority

| System priority | Recording mode       | Description   |
|-----------------|----------------------|---|
| 4K              | RAW                  | Standard recording mode for 4K clips. This recording mode features a 10-bit bit depth and should be used if you plan to develop the clip using the <b>Cinema RAW Development</b> software ( 150).   |
|                 | HRAW                 | Recording mode for use with slow & fast motion recording ( 108) when you want to set the shooting frame rate from 62 to 120P (for 59.94 Hz recordings) or 52 to 100P (for 50.00 Hz recordings).   |
|                 | 4K1K RAW             | Recording mode that features half the vertical resolution of RAW recording. You can set the shooting frame rate from 62 to 120P (for 59.94 recordings) or 52 to 100P (for 50.00 Hz recordings). This recording mode can be used with slow & fast motion recording. When you develop the clip using the <b>Cinema RAW Development</b> software ( 150), you can cover it using options such as 4K1K video, 4K2K video (letterboxed) and 2K/1K video/full HD video (side-cropped). |
| 2K              | <b>RGB444</b> 12-bit | Standard recording modes for 2K clips. These recording modes use the RGB color space, 4:4:4 color sampling, and have a 12-bit or 10-bit bit depth. High image quality than <b>YCC422</b> 10-bit mode.   |
|                 | <b>RGB444</b> 10-bit |   |
|                 | <b>YCC422</b> 10-bit | Recording mode for use with slow & fast motion recording ( 108) when you want to set the shooting frame rate from 62 to 120P (for 59.94 Hz recordings) or 52 to 100P (for 50.00 Hz recordings). This recording mode uses the YCC color space, 4:2:2 color sampling, and has a 10-bit bit depth.   |

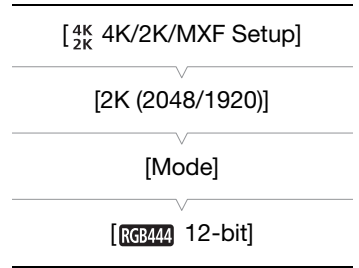

**i** NOTES

- During slow & fast motion recording, when you want to set the shooting frame rate to 1 to 60P (for 59.94 Hz recordings) or 1 to 50P (for 50.00 Hz recordings), we recommend you set [Mode] to [RAW], **RGB444** 12-bit or **RGB444** 10-bit.

### Selecting the Resolution

- 1 Open the [Resolution] submenu.  
 [ <sup>4K</sup>/<sub>2K</sub> 4K/2K/MXF Setup ] ➤ [4K (4096/3840)] or [2K (2048/1920)] ➤ [Resolution]
- 2 Select the desired resolution and then press SET.
  - Available resolution options depend on the system priority and recording mode settings.

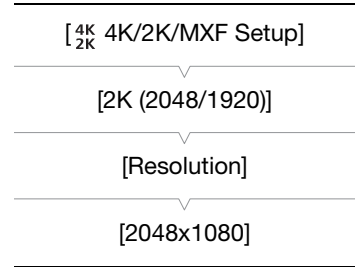
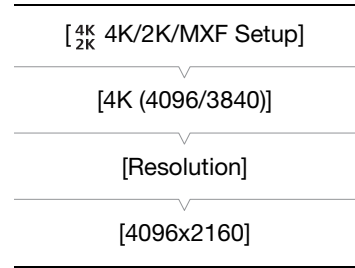

### Selecting the Frame Rate

This procedure is not necessary for 24.00 Hz recordings because the frame rate will automatically be set to [24.00P].

- 1 Open the [Frame Rate] submenu.  
 [ <sup>4K</sup>/<sub>2K</sub> 4K/2K/MXF Setup ] ➤ [4K (4096/3840)] or [2K (2048/1920)] ➤ [Frame Rate]
- 2 Select the desired frame rate and then press SET.
  - The available frame rates depend on the system priority, system frequency, recording mode and resolution settings.

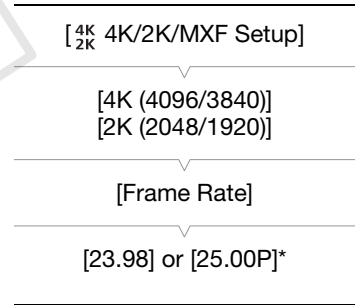

### NOTES

- Onscreen displays representing the mode, resolution and frame rate that you selected will appear on the upper right of the screen.
- For details on the signal output from the 3G-SDI terminals, refer to *Connecting to a 4K- or 2K-Compatible External Recorder* (41). For details on the signal output from the other terminals, refer to *Video Output Configuration* (139).

\* Depending on the country/region of purchase.

### Available system frequency, system priority, recording mode, resolution, and frame rate settings

| System priority | System frequency →   | 59.94 Hz     |        |        | 50.00 Hz |        | 24.00 Hz |
|-----------------|----------------------|--------------|--------|--------|----------|--------|----------|
|                 | Mode / Resolution ↓  | Frame rate ↓ |        |        |          |        |          |
|                 |                      | 23.98P       | 29.97P | 59.94P | 25.00P   | 50.00P | 24.00P   |
| 4K              | RAW / 4096×2160      | ●            | ●      | ●      | ●        | ●      | ●        |
|                 | HRAW/ 4096×1080      | -            | -      | ●      | -        | ●      | -        |
|                 | 4K1K RAW / 4096x1080 | -            | -      | ●      | -        | ●      | -        |
|                 | RAW / 3840×2160      | ●            | ●      | ●      | ●        | ●      | ●        |
|                 | HRAW/ 3840×1080      | -            | -      | ●      | -        | ●      | -        |

| System priority | System frequency →               | 59.94 Hz     |        |        | 50.00 Hz |        | 24.00 Hz |
|-----------------|----------------------------------|--------------|--------|--------|----------|--------|----------|
|                 | Mode / Resolution ↓              | Frame rate ↓ |        |        |          |        |          |
|                 |                                  | 23.98P       | 29.97P | 59.94P | 25.00P   | 50.00P | 24.00P   |
| 2K              | <b>RGB444</b> 12-bit / 2048×1080 | ●            | ●      | ●      | ●        | ●      | ●        |
|                 | <b>RGB444</b> 10-bit / 2048×1080 | ●            | ●      | ●      | ●        | ●      | ●        |
|                 | <b>YCC422</b> 10-bit / 2048×1080 | –            | –      | ●      | –        | ●      | –        |
|                 | <b>RGB444</b> 12-bit / 1920×1080 | ●            | ●      | ●      | ●        | ●      | ●        |
|                 | <b>RGB444</b> 10-bit / 1920×1080 | ●            | ●      | ●      | ●        | ●      | ●        |
|                 | <b>YCC422</b> 10-bit / 1920×1080 | –            | –      | ●      | –        | ●      | –        |

### Recording MXF Clips on a CF Card During 4K and 2K Modes

While recording on an external recorder in 4K and 2K modes, the camera can simultaneously record an MXF clip on a CF card inserted in the camera, except during special recording modes. The selected video configuration for 4K and 2K modes will be converted to HD video and recorded onto the CF card. You can select the video configuration of the MXF clips that are recorded on the CF card.

#### Video configuration recorded on CF card

| Video configuration for external recording |  |                         |            | Video configuration recorded on CF card                           |                            |
|--|--|-------------------------|------------|---|----------------------------|
| System priority                            | Recording mode                               | Resolution              | Frame rate | Bit rate / Resolution   | Frame rate                 |
| 4K   | RAW  | 4096×2160<br>3840×2160  | 59.94P     | 50 Mbps / 1920x1080<br>35 Mbps / 1920x1080<br>25 Mbps / 1440x1080 | 29.97P<br>23.98P<br>25.00P |
|  |  |                         | 29.97P     |   |                            |
|  |  |                         | 23.98P     |   |                            |
|  |  |                         | 50.00P     |   |                            |
|  |  |                         | 25.00P     |   |                            |
|  |  |                         | 24.00P     |   |                            |
|  | HRAW<br>4K1K RAW                             | 4096×1080<br>3840×1080* | 59.94P     | 50 Mbps / 1280x720  | 59.94P                     |
|  |  |                         | 50.00P     | 35 Mbps / 1280x720  | 50.00P                     |
| 2K   | <b>RGB444</b> 12-bit<br><b>RGB444</b> 10-bit | 2048×1080<br>1920×1080  | 59.94P     | 50 Mbps / 1920x1080<br>35 Mbps / 1920x1080<br>25 Mbps / 1440x1080 | 29.97P<br>23.98P<br>25.00P |
|  |  |                         | 29.97P     |   |                            |
|  |  |                         | 23.98P     |   |                            |
|  |  |                         | 50.00P     |   |                            |
|  |  |                         | 25.00P     |   |                            |
|  |  |                         | 24.00P     |   |                            |
|  | <b>YCC422</b> 10-bit                         | 2048×1080<br>1920×1080  | 59.94P     | 50 Mbps / 1280x720  | 59.94P                     |
|  |  |                         | 50.00P     | 35 Mbps / 1280x720  | 50.00P                     |

\* HRAW only.

### Selecting the Resizing Method When Converting to HD Video

When converting 4K or 2K image data with a resolution of 4096x2160, 4096x1080 or 2048x1080 to MXF video with a resolution of 1920x1080, you can select how it will be recorded on a CF card or output from the HD/SD SDI terminal, HDMI OUT terminal and SYNC OUT terminal (only when [HD-Y] is selected).

- Open the [Resize MXF Output] submenu.  
[4K/2K 4K/2K/MXF Setup] ► [Resize MXF Output]
- Select [Letterbox], [Squeeze] or [Side Crop] and then press SET.
  - The options are the same as those listed for *Selecting the Resizing Method* (145).

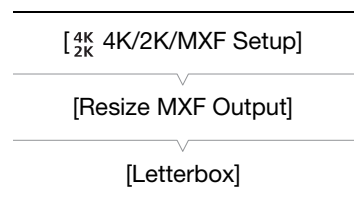

**i** NOTES

- If you set an assignable button to [Resize MXF Output] (📖 111), you can press the button to switch the resizing method.
- During 4K and 2K modes, the picture output from the 3G-SDI terminals and the picture recorded on a CF card will differ in image quality due to differences in the signal processing algorithm.
- Because the camera uses a simple resize conversion process vertically, diagonal lines may appear jagged.

### Selecting the Video Configuration for MXF Mode

To set the video configuration, select the system frequency, system priority, bit rate and resolution, and frame rate, as necessary. For a summary of the video configuration, refer to the table following the procedures below.

Operating modes: CAMERA | MEDIA | 4K | 2K | MXF

#### Selecting the System Priority

- 1 Open the [System Priority] submenu.  
[4K/2K 4K/2K/MXF Setup] ➤ [System Priority]
- 2 Select [MXF] and then press SET.
  - The camera will restart in MXF mode.

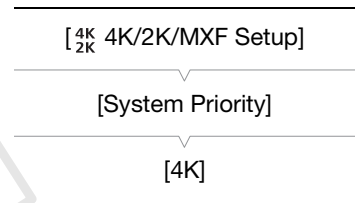

#### Selecting the System Frequency

- 1 Open the [System Frequency] submenu.  
[4K/2K 4K/2K/MXF Setup] ➤ [System Frequency]
- 2 Select a desired option and then press SET.
  - The camera will restart in the selected mode.

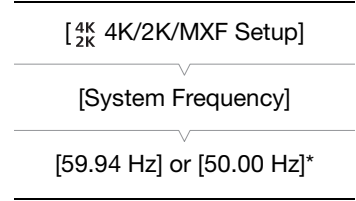

\* Depending on the country/region of purchase.

#### Selecting the Bit Rate and Resolution

- 1 Open the [Bit Rate/Resolution] submenu to set the bit rate and resolution.  
[4K/2K 4K/2K/MXF Setup] ➤ [MXF] ➤ [Bit Rate/Resolution]
- 2 Select the desired option and then press SET.
  - The selected bit rate and resolution will appear on the upper right of the screen.

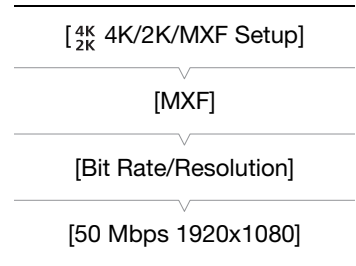



## Selecting the Frame Rate

This procedure is not necessary for 24.00 Hz recordings.

1 Open the [Frame Rate] submenu to set the frame rate.

[ $\frac{4K}{2K}$  4K/2K/MXF Setup] ► [MXF] ► [Frame Rate]

2 Select the desired option and then press SET.

- The selected frame rate will appear on the upper right of the screen.



### NOTES

- A single CF card cannot be used to record clips with different system frequencies (59.94 Hz/50.00 Hz/24.00 Hz).

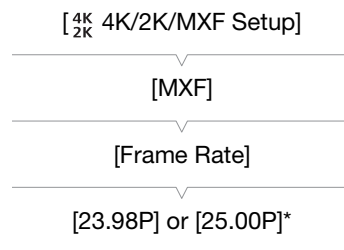

\* Depending on the country/region of purchase.

## Available bit rate, resolution and frame rate settings

| Bit rate*              | System frequency →<br>Resolution ↓ | 59.94 Hz     |        |        |        | 50.00 Hz |        |        | 24.00 Hz |
|------------------------|------------------------------------|--------------|--------|--------|--------|----------|--------|--------|----------|
|                        |                                    | Frame rate ↓ |        |        |        |          |        |        |          |
|                        |                                    | 59.94i       | 59.94P | 29.97P | 23.98P | 50.00i   | 50.00P | 25.00P | 24.00P   |
| 50 Mbps<br>(CBR 4:2:2) | 1920×1080                          | ●            | –      | ●      | ●      | ●        | –      | ●      | ●        |
|                        | 1280×720                           | –            | ●      | ●      | ●      | –        | ●      | ●      | ●        |
| 35 Mbps<br>(VBR 4:2:0) | 1920×1080                          | ●            | –      | ●      | ●      | ●        | –      | ●      | –        |
|                        | 1280×720                           | –            | ●      | ●      | ●      | –        | ●      | ●      | –        |
| 25 Mbps<br>(CBR 4:2:0) | 1440×1080                          | ●            | –      | ●      | ●      | ●        | –      | ●      | –        |

\* The first line indicates the bit rate (in Mbps); the second line indicates in parentheses whether the bit rate is constant (CBR) or variable (VBR), and the color sampling. The recordings have 8-bit bit depth.

## Changing Main Camera Functions with the FUNC. Button

You can adjust three main camera functions –shutter speed, white balance and ISO speed/gain– using the FUNC. button (direct setting mode). In direct setting mode, you can change settings using the LCD screen/viewfinder or using only the rear panel, which is convenient when the monitor unit is not attached to the camera. This section will explain the basic operation of the direct setting mode. For specific details about the functions please refer to the each function's section: shutter speed (☞ 67), white balance (☞ 76), ISO speed/gain (☞ 70).

Operating modes: CAMERA MEDIA | 4K 2K MXF

### Using the Direct Setting Mode

#### 1 Press the FUNC. button.

- **On the screen:** The onscreen display of the function to be adjusted will be highlighted in orange.
- **On the rear panel:** Only the icon (white balance) or value (ISO speed, gain, shutter speed) of the function to be adjusted will be displayed.
- Repeatedly pressing the FUNC. button will change the function to be adjusted in the following order: White balance → ISO speed/gain → Shutter speed → Direct setting mode off.

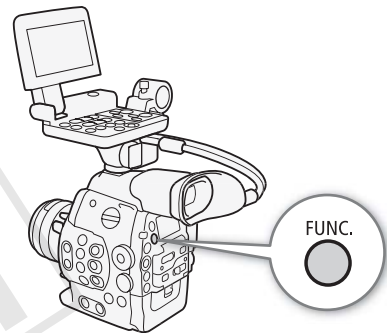

#### 2 Push the joystick up/down or turn the SELECT dial to select the desired value (ISO speed, gain, shutter speed) or desired white balance mode and then press SET.

- The selected value will be set and the camera will exit the direct setting mode.
- **On the screen:** The onscreen display of the selected function will return to normal.
- **On the rear panel:** The display will return to normal (all displays will reappear).
- Depending on the function selected, additional adjustment may be possible or necessary before pressing SET.

#### NOTES

- The camera will automatically end the direct setting mode in the following cases.
  - If no operation was performed for more than 6 seconds.
  - If the menu, custom picture menu or a status screen was opened.
  - If the aperture was adjusted or the ND filter setting was changed.
  - If the control dial's function is set to [ISO/Gain] and you operate the control dial while adjusting the white balance or shutter speed in direct setting mode.
- If you set an assignable button to [FUNC.] (☞ 111), you can press that button instead of the FUNC. button to enter the direct setting mode.

## Shutter Speed

Set the shutter speed based on the recording conditions. For example, you may want to set slower shutter speeds in darker environments. The camera offers the following 5 modes.

Operating modes: CAMERA MEDIA | 4K 2K MXF

[Speed]: Allows you to set the shutter speed (in fractions of a second). You can select the increment to use when adjusting the shutter speed between 1/3-stop and 1/4-stop increments.

[Angle]: You can set the shutter angle to determine the shutter speed.

[Clear Scan]: Set the frequency in order to record CRT computer monitors without displaying black bands or flicker on the screen.

[Slow]: You can set slower shutter speeds to obtain brighter recordings in places with insufficient lighting. This mode is not available during slow & fast motion recording mode.

[Off]: The camera uses a standard shutter speed based on the frame rate.

### Available Shutter Speeds

The available shutter speeds vary depending on the frame rate.

| Shutter speed mode      |                     | Frame rate (59.94 Hz and 24.00 Hz recordings)   |   |   |
|-------------------------|---------------------|---|---|---|
|                         |                     | 59.94i / 59.94P   | 29.97P  | 23.98P / 24.00P   |
| Off <sup>1</sup>        |                     | 1/60  | 1/30  | 1/24  |
| Speed <sup>1,2</sup>    | 1/3-stop increments | 1/60, 1/80, 1/100, 1/125, 1/160, 1/200, 1/250, 1/320, 1/400, 1/500, 1/640, 1/800, 1/1000, 1/1250, 1/1600, 1/2000                                    | 1/30, 1/40, 1/50, 1/60, 1/80, 1/100, 1/125, 1/160, 1/200, 1/250, 1/320, 1/400, 1/500, 1/640, 1/800, 1/1000, 1/1250, 1/1600, 1/2000  | 1/25, 1/30, 1/40, 1/50, 1/60, 1/80, 1/100, 1/125, 1/160, 1/200, 1/250, 1/320, 1/400, 1/500, 1/640, 1/800, 1/1000, 1/1250, 1/1600, 1/2000  |
|                         | 1/4-stop increments | 1/60, 1/75, 1/90, 1/100, 1/120, 1/150, 1/180, 1/210, 1/250, 1/300, 1/360, 1/420, 1/500, 1/600, 1/720, 1/840, 1/1000, 1/1200, 1/1400, 1/1700, 1/2000 | 1/30, 1/34, 1/40, 1/48, 1/60, 1/75, 1/90, 1/100, 1/120, 1/150, 1/180, 1/210, 1/250, 1/300, 1/360, 1/420, 1/500, 1/600, 1/720, 1/840, 1/1000, 1/1200, 1/1400, 1/1700, 1/2000 | 1/24, 1/30, 1/34, 1/40, 1/48, 1/60, 1/75, 1/90, 1/100, 1/120, 1/150, 1/180, 1/210, 1/250, 1/300, 1/360, 1/420, 1/500, 1/600, 1/720, 1/840, 1/1000, 1/1200, 1/1400, 1/1700, 1/2000 |
| Angle <sup>1</sup>      |                     | 360°, 240°, 216°, 180°, 120°, 90°, 60°, 45°, 30°, 22.5°, 15°, 11.25°  | 360°, 240°, 216°, 180°, 120°, 108°, 90°, 60°, 45°, 30°, 22.5°, 15°, 11.25°  | 360°, 345.6°, 288°, 240°, 180°, 172.8°, 144°, 120°, 90°, 86.4°, 72°, 60°, 45°, 30°, 22.5°, 15°, 11.25°  |
| Clear Scan <sup>1</sup> |                     | 59.94 Hz to 250.27 Hz   | 29.97Hz to 250.27 Hz  | 23.98 Hz or 24.00 Hz to 250.27 Hz   |
| Slow <sup>3</sup>       |                     | 1/4, 1/8, 1/15, 1/30  | 1/4, 1/8, 1/15  | 1/3, 1/6, 1/12  |

| Shutter speed mode      |                     | Frame rate (50.00 Hz recordings)  |   |
|-------------------------|---------------------|---|---|
|                         |                     | 50.00i / 50.00P   | 25.00P  |
| Off <sup>1</sup>        |                     | 1/50  | 1/25  |
| Speed <sup>1,2</sup>    | 1/3-stop increments | 1/50, 1/60, 1/80, 1/100, 1/125, 1/160, 1/200, 1/250, 1/320, 1/400, 1/500, 1/640, 1/800, 1/1000, 1/1250, 1/1600, 1/2000                                    | 1/25, 1/30, 1/40, 1/50, 1/60, 1/80, 1/100, 1/125, 1/160, 1/200, 1/250, 1/320, 1/400, 1/500, 1/640, 1/800, 1/1000, 1/1250, 1/1600, 1/2000  |
|                         | 1/4-stop increments | 1/50, 1/60, 1/75, 1/90, 1/100, 1/120, 1/150, 1/180, 1/210, 1/250, 1/300, 1/350, 1/400, 1/500, 1/600, 1/700, 1/800, 1/1000, 1/1200, 1/1400, 1/1600, 1/2000 | 1/25, 1/29, 1/33, 1/40, 1/50, 1/60, 1/75, 1/90, 1/100, 1/120, 1/150, 1/180, 1/210, 1/250, 1/300, 1/350, 1/400, 1/500, 1/600, 1/700, 1/800, 1/1000, 1/1200, 1/1400, 1/1600, 1/2000 |
| Angle <sup>1</sup>      |                     | 360°, 300°, 240°, 180°, 150°, 120°, 90°, 60°, 45°, 30°, 22.5°, 15°, 11.25°  | 360°, 300°, 240°, 180°, 150°, 120°, 90°, 75°, 60°, 45°, 30°, 22.5°, 15°, 11.25°   |
| Clear Scan <sup>1</sup> |                     | 50.00 Hz to 250.78 Hz   | 25.00 Hz to 250.78 Hz   |
| Slow <sup>3</sup>       |                     | 1/3, 1/6, 1/12, 1/25  | 1/3, 1/6, 1/12  |

<sup>1</sup> During slow & fast motion recording mode, available values will vary depending on the selected shooting frame rate.

<sup>2</sup> In the Wi-Fi Remote application, all shutter speeds (1/3-stop and 1/4-stop increments) will be available from the same list.

<sup>3</sup> Not available during slow & fast motion recording mode.

## Changing the Shutter Speed Mode and Value

1 Open the shutter [Mode] submenu.

[Camera Setup] ➤ [Shutter] ➤ [Mode]

2 Select the desired mode and then press SET.

- If you selected [Speed] you can select the increment scale to use when adjusting the shutter speed; otherwise, skip to step 5.

3 Open the [Shutter Increment] submenu.

[Camera Setup] ➤ [Shutter] ➤ [Shutter Increment]

4 Select [1/3 stop] or [1/4 stop] and then press SET.

5 Adjust the shutter speed, angle value or clear scan frequency using the direct setting mode.

- Repeatedly press the FUNC. button to highlight the shutter speed display, select the desired value and then press SET. For details refer to *Using the Direct Setting Mode* (66).

### **i** NOTES

- If you set an assignable button to [FUNC. Shutter] (111), you can press the button to enter the direct setting mode with the shutter speed highlighted and ready to be adjusted.

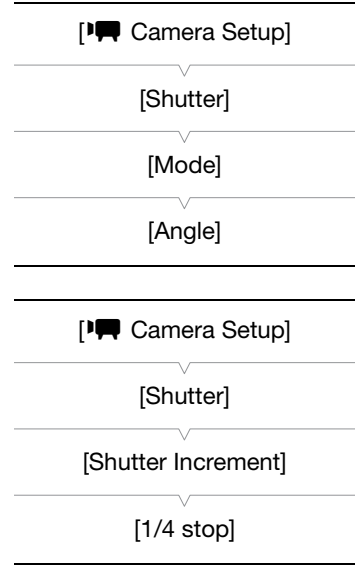

## Remote Operation Using Wi-Fi Remote

After completing the necessary preparations (49) you can adjust the shutter speed remotely from a Wi-Fi-enabled device using the Wi-Fi Remote application.

1 Press [ANGLE] on the Wi-Fi Remote screen.

2 Select the desired mode.

3 Press the current shutter speed, angle value or clear scan frequency and select the desired value from the list.

- You may need to scroll up/down to see all the available values.
- The selected value will be displayed on the Wi-Fi Remote screen and will be applied on the camera.

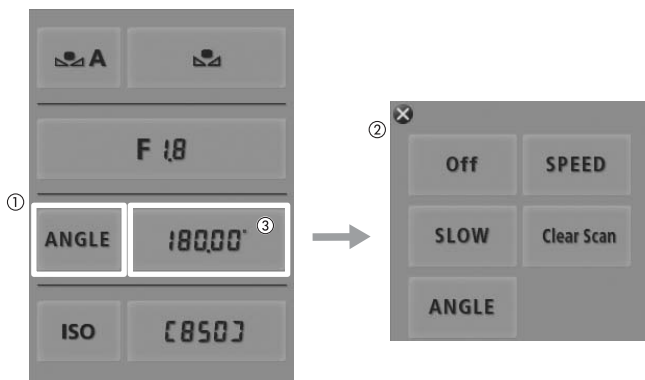



### Using Slow Shutter Mode

When recording in dark surroundings, you can obtain a brighter picture by using slow shutter mode. You can also use this mode when you wish to add certain effects to your recordings, such as blurring the background during panning shots or recording a moving subject with an afterimage trail.

- Image quality may not be as good as when using faster shutter speeds in brighter surroundings.

### NOTES

- When recording under artificial light sources such as fluorescent, mercury or halogen lamps, the screen may flicker depending on the shutter speed. You may be able to avoid flicker by setting the shutter mode to [Speed] and the shutter speed to a value matching the frequency of the local electrical system: 1/50\* or 1/100 (for 50 Hz recordings) or 1/60 or 1/120 (for 60 Hz recordings).  
\* May not be available depending on the frame rate.
- Closing down the aperture when recording under bright conditions may cause the picture to appear soft or out of focus. To avoid the loss of sharpness due to diffraction, use a faster shutter speed, a denser ND filter ( 73) or open up the aperture.
- When the shutter speed mode is set to [Slow], bright red, green or blue dots may appear on the screen. In such case, use a faster shutter speed or select a lower ISO speed or gain value ( 70).
- Even when using the [C9: EOS Std.] preset custom picture file, if you set the camera to a certain shutter speed, you may not get the exactly the same image brightness as you would on an EOS digital SLR camera set to the same shutter speed.

COPY

## ISO Speed/Gain

Depending on the shooting conditions you may want to adjust the brightness of the image. You can do so by changing the ISO speed or gain value to adjust the sensitivity of the sensor.

Operating modes: CAMERA MEDIA | 4K 2K MXF

### Available ISO speed and gain settings

|           | Increment           | Normal range   | Extended range <sup>1</sup>              |
|-----------|---------------------|--|--|
| ISO Speed | 1-stop increments   | 320 <sup>2</sup> , 400, 800, <850> <sup>3</sup> , 1600, 3200, 6400, 12800, 20000 <sup>2,4</sup>                                      | 25600, 51200, 80000 <sup>2</sup>         |
|           | 1/3-stop increments | 320, 400, 500, 640, 800, <850> <sup>3</sup> , 1000, 1250, 1600, 2000, 2500, 3200, 4000, 5000, 6400, 8000, 10000, 12800, 16000, 20000 | 25600, 32000, 40000, 51200, 64000, 80000 |
| Gain      | Normal              | -6 dB, -3 dB, 0 dB, 3 dB, 6 dB, 9 dB, 12 dB, 15 dB, 18 dB, 21 dB, 24 dB, 27 dB, 30 dB  | 33 dB, 36 dB, 39 dB, 42 dB               |
|           | Fine                | 0 dB to 24 dB in 0.5 dB increments   | –  |

<sup>1</sup> Settings available only when [Camera Setup] ➤ [ISO/Gain] ➤ [Extended Range] is set to [On].

<sup>2</sup> The minimum and maximum ISO speeds are available even when the 1-stop increment scale is selected.

<sup>3</sup> ISO speed required for a suitable dynamic range for Canon Log gamma. Equivalent to a gain value of 2.5 dB.

<sup>4</sup> This value is only available when [Extended Range] is set to [Off].

### Changing the ISO Speed or Gain Value

1 Open the ISO Speed/Gain [Select] submenu.

[Camera Setup] ➤ [ISO/Gain] ➤ [Select]

2 Select [ISO] or [Gain] and then press SET.

**If you selected [ISO] (the default value):**

3 Open the [ISO Increment] submenu to select the increment to use when adjusting the ISO speed.

[Camera Setup] ➤ [ISO/Gain] ➤ [ISO Increment]

4 Select [1 stop] or [1/3 stop] and then press SET.

5 Adjust the ISO speed using the direct setting mode.

- Repeatedly press the FUNC. button to highlight the ISO speed display, select the desired value and then press SET. For details refer to *Using the Direct Setting Mode* (66).

**If you selected [Gain]:**

3 Open the [Gain] submenu to select the increment to use when adjusting the gain.

[Camera Setup] ➤ [ISO/Gain] ➤ [Gain]

4 Select [Normal] (3-dB increment) or [Fine] (0.5-dB increment) and then press SET.

5 Adjust the gain using the direct setting mode.

- Repeatedly press the FUNC. button to highlight the gain display, select the desired value and then press SET. For details refer to *Using the Direct Setting Mode* (66).

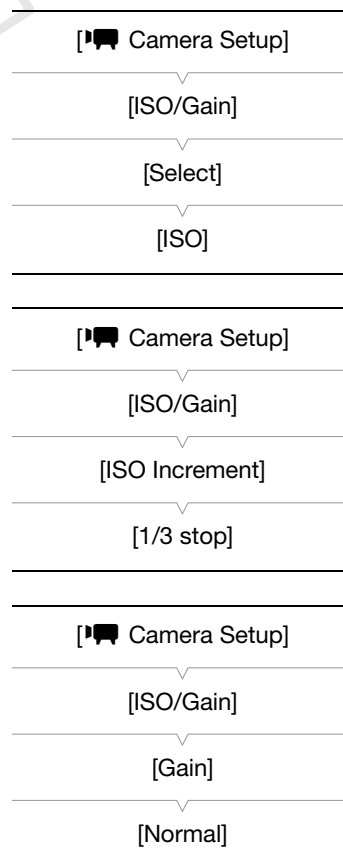

**i** NOTES

- If you set an assignable button to [FUNC. ISO/Gain] (📖 111), you can press the button to enter the direct setting mode with the ISO speed/gain highlighted and ready to be adjusted.

**Using the Control Dial**

You can adjust the value of the ISO speed or gain using the control dial on the camera. When you have attached the grip unit of the C300 / C300 PL or C100 to the camera, you can select the function assigned to each control dial independently.

You will need to set the control dial's function to [ISO/Gain] in advance.

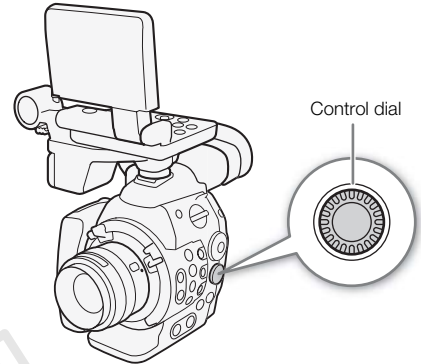
**Assigning ISO Speed/Gain Control to the Control Dial**

1 Open the [Control Dial] submenu.

[👉 Other Functions] ➤ [Custom Function] ➤ [Control Dial]\*

\* When you are assigning the function to the control dial on the grip unit of the C300 / C300 PL or C100, select [Grip Ctrl Dial] instead.

2 Select [ISO/Gain] and then press SET.

**Changing the ISO Speed or Gain Value**

To select whether to change the ISO speed or the gain, perform steps 1 to 4 in the previous procedure. Turn the control dial to set the desired ISO speed or gain value.

**i** NOTES

- You can use the [👉 Other Functions] ➤ [Custom Function] ➤ [Control Dial Dir.] or [Grip Dial Dir.] setting (📖 122) to change the direction of the adjustment when you turn the control dial on the camera or on the grip unit of the C300 / C300 PL or C100, respectively.

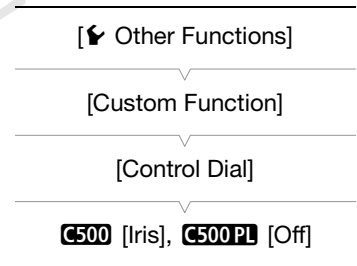
**Remote Operation Using Wi-Fi Remote**

After completing the necessary preparations (📖 49) you can adjust the ISO speed/gain remotely from a Wi-Fi-enabled device using the Wi-Fi Remote application.

1 To change the gain value, press [ISO] and then [Gain] on the Wi-Fi Remote screen.

2 Press the current ISO speed or gain value and select the desired value from the list.

- You may need to scroll up/down to see all the available values.
- The selected value will be displayed on the Wi-Fi Remote screen and will be applied on the camera.

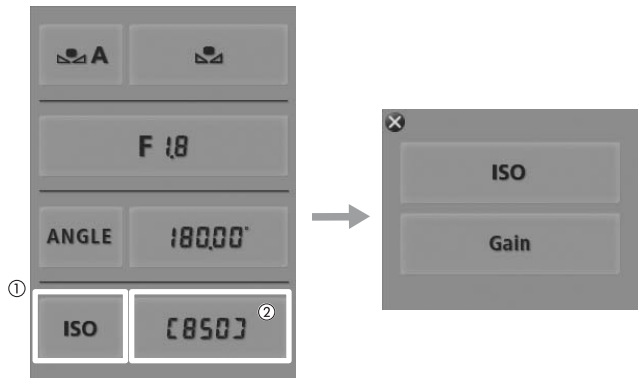
**i** NOTES

- When high ISO speeds or gain levels are set, the picture may flicker slightly. ISO 12800 / 30 dB gain and higher values in particular, allow you to shoot video with a higher sensitivity but are more prone to the appearance of noise.
- When high ISO speeds or gain levels are set, bright red, green or blue dots may appear on the screen. In such case, use a faster shutter speed (📖 67) or select a lower ISO speed or gain value.
- When the ISO speed or gain level is changed, some noise may appear momentarily on the screen. Do not adjust the ISO speed/gain level while recording.

COPY



## ND Filter

Using the ND filters allows you keep the aperture within an appropriate range when recording in bright surroundings\*.

\* Closing down the aperture when recording under bright conditions may cause the picture to appear soft or out of focus. To avoid the loss of sharpness due to diffraction, use a denser ND filter or a faster shutter speed (☞ 67).

Operating modes: CAMERA MEDIA | 4K 2K MXF

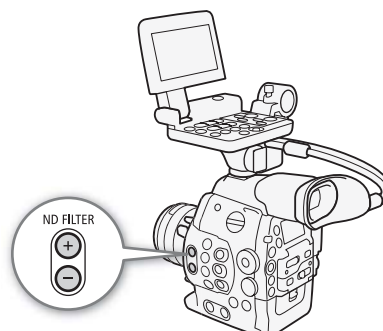

### Using the ND Filter

Press the ND FILTER + or - button to select the desired ND filter setting.

- Repeatedly pressing ND FILTER + button will change the ND filter setting in the following order: [ND1 2 stops] → [ND2 4 stops] → [ND3 6 stops] → ND filter off. (The ND FILTER - button cycles through the settings in reverse order.)

### Remote Operation Using Wi-Fi Remote

After completing the necessary preparations (☞ 49) you can adjust the ND filter remotely from a Wi-Fi-enabled device using the Wi-Fi Remote application.

Press [ND +] or [ND -] on the Wi-Fi Remote screen.

- The function is identical to that of the ND FILTER + and - buttons on the camera.
- The selected ND filter setting will be displayed on the Wi-Fi Remote screen and will be applied on the camera.

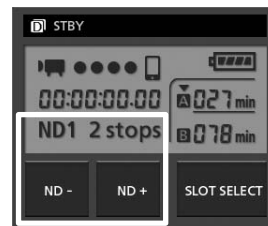

#### **i** NOTES

- Depending on the scene, the color may change when turning the ND filter on/off. Setting a custom white balance (☞ 76) may be effective in such case.
- If you set an assignable button to [ND -] or [ND +] (☞ 111), you can press the button to adjust the ND filter.

## C500 Adjusting the Aperture

You can affect the brightness of your recordings or change the depth of field by adjusting the aperture. For example, use a small aperture value for a shallow depth of field that isolates the subject in focus and nicely blurs the background. Available aperture values will vary depending on the EF lens attached to the camera.

Operating modes: CAMERA MEDIA | 4K 2K MXF

### Using the Control Dial

You can adjust the aperture value of most EF lenses using the control dial on the camera. When you have attached the grip unit of the C300 / C300 PL or C100 to the camera, you can select the function assigned to each control dial independently.

By default the control dial's function is set to aperture control. If it has been changed, follow the procedure below to set the control dial's function to [Iris] in advance.

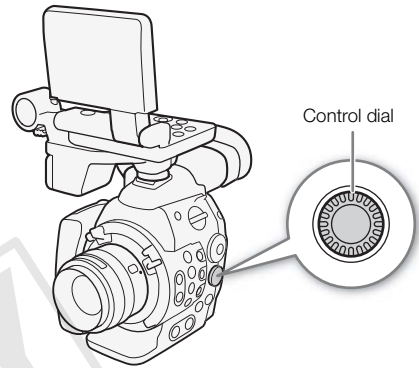

### Assigning Aperture Control to the Control Dial

1 Open the [Control Dial] submenu.

[Other Functions] ➤ [Custom Function] ➤ [Control Dial]\*

\* When you are assigning the function to the control dial on the grip unit of the C300 / C300 PL or C100, select [Grip Ctrl Dial] instead.

2 Select [Iris] and then press SET.

### Selecting the Increment Scale to Use When Adjusting the Aperture

1 Open the [Iris Increment] submenu.

[Camera Setup] ➤ [Iris] ➤ [Iris Increment]

2 Select [1/2 stop], [1/3 stop] or [Fine] and then press SET.

### Changing the Aperture Value

Turn the control dial to adjust the aperture.

- The selected aperture value will appear on the lower left of the screen.
- When [Camera Setup] ➤ [Iris] ➤ [Iris Increment] is set to [Fine], the actual increments will be smaller than 1/3 stop but the onscreen display will show the closest 1/3-stop aperture value.

### NOTES

- You can use the [Other Functions] ➤ [Custom Function] ➤ [Control Dial Dir.] or [Grip Dial Dir.] setting (122) to change the direction of the adjustment when you turn the control dial.

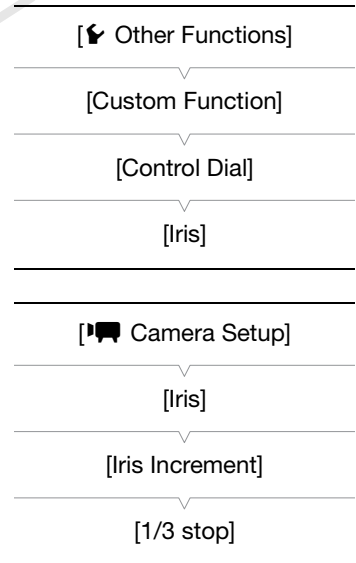

## Remote Operation Using Wi-Fi Remote

After completing the necessary preparations (📖 49) you can adjust the aperture value remotely from a Wi-Fi-enabled device using the Wi-Fi Remote application.

1 Press the current aperture value on the Wi-Fi Remote screen.

2 Select the desired aperture value from the list.

- You may need to scroll up/down to see all the available values.
- Alternatively, you can press IRIS [+] to open the aperture or IRIS [-] to close the aperture in 1/8-stop increments. (Onscreen displays will show the closest 1/3-stop aperture value.)
- The selected value will be displayed on the Wi-Fi Remote screen and will be applied on the lens.





### **i** NOTES

- When using an EF lens with no lens contacts, such as a Canon Cinema Lens, you cannot adjust the aperture using the camera. Adjust the aperture using the lens.
- When using an EF lens that can correct the aperture value according to the position of the zoom, you can use the [🗨 Camera Setup] ➤ [Iris] ➤ [Zoom-Iris Correct.] setting to activate this correction.

## White Balance

The camera uses an electronic white balance process to calibrate the picture and ensure accurate colors under different lighting conditions. There are 3 methods of setting the white balance.

**Custom white balance:** You can use a white object to establish the white balance and set it to one of two custom white balance positions, A or B.



**Set color temperature:** Allows you to set the color temperature between 2,000 K and 15,000 K.

**Preset white balance:** Set the white balance to  (daylight) or  (incandescent lamp). Preset white balance settings can be further fine-tuned within a range of -9 to 9.

When recording under fluorescent lights, we recommend setting the custom white balance.

Operating modes:   |   

### NOTES

- When recording on a CF card, the [Color Matrix] and [White Balance] custom picture settings (📖 120) take precedence over the white balance settings.
- You can use the [ Other Functions]  [Custom Function]  [Shockless WB] setting (📖 122) to make the transition look smoother when you change the white balance settings.



## Setting the White Balance

### 1 Set the white balance mode using the direct setting mode.

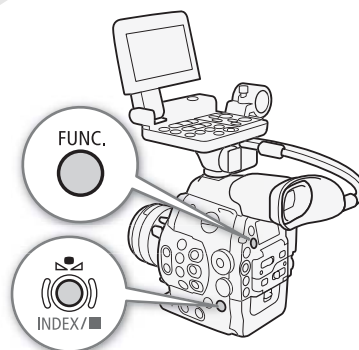
- Press the FUNC. button to highlight the white balance icon and select the desired white balance mode.
- To apply the setting as it is, press SET. To establish the custom white balance, fine-tune the preset white balance settings or change the color temperature, continue the procedure as described below before pressing SET.
- For details refer to *Using the Direct Setting Mode* (📖 66).





### If you selected one of the custom white balance settings A or B:

If a custom white balance has not yet been stored, the custom white balance icon A or B and default value (5,500 K) will flash slowly. To establish the custom white balance:

### 2 Point the camera at a white object so that it fills the whole screen.

- Use the same lighting conditions you plan to use when recording.

### 3 Press the button.

- The  A or  B icon will flash quickly.
- Make sure the white object fills the screen until the procedure is completed.
- After the icon stops flashing, the procedure is completed and the camera will exit the direct setting mode. The setting is retained even if you turn off the camera.

### If you selected one of the preset white balance settings, or :

You can fine-tune the preset values within a range of -9 to 9.

### 2 Press the button.

- **On the screen:** The adjustment value  $\pm 0$  will appear next to the white balance icon, highlighted in orange.
- **On the rear panel:** The adjustment value  $\pm 0$  will appear.

- 3 Push the joystick up/down or turn the SELECT dial to change the adjustment value and then press SET.
- The selected adjustment value will be set and the camera will exit the direct setting mode.
  - **On the screen:** The selected adjustment value will appear next to the white balance icon.
  - **On the rear panel:** The adjustment value display will disappear and the display will return to normal (all displays will reappear). The white balance fine-tuning icon  will appear to indicate that an adjustment has been made.

**If you selected the color temperature setting, .**

You can set the color temperature between 2,000 K and 15,000 K in 100 K increments.

- 2 Press the  button.
- **On the screen:** The default color temperature value (5,500 K) will be highlighted in orange.
  - **On the rear panel:** The default color temperature value will appear.
- 3 Push the joystick up/down or turn the SELECT dial to change the color temperature value and then press SET.
- The selected color temperature will be set and the camera will exit the direct setting mode.
  - **On the screen:** The selected color temperature will appear next to the white balance icon.
  - **On the rear panel:** The color temperature value will disappear and the display will return to normal (all displays will reappear).



 NOTES





- If you set an assignable button to [FUNC. WB] ( 111), you can press the button to enter the direct setting mode with the white balance icon highlighted and ready to be adjusted.

## Remote Operation Using Wi-Fi Remote

After completing the necessary preparations ( 49) you can adjust the white balance remotely from a Wi-Fi-enabled device using the Wi-Fi Remote application.

- 1 Press [A] on the Wi-Fi Remote screen.
- 2 Select the desired white balance mode.

**If you selected ,  or .**

- 3 Press the adjustment value [ ±0] (, ) or color temperature [5500K] () and then select the desired value from the list.
- You may need to scroll up/down to see all the available values.

- The selected value will be displayed on the Wi-Fi Remote screen and will be applied on the camera.

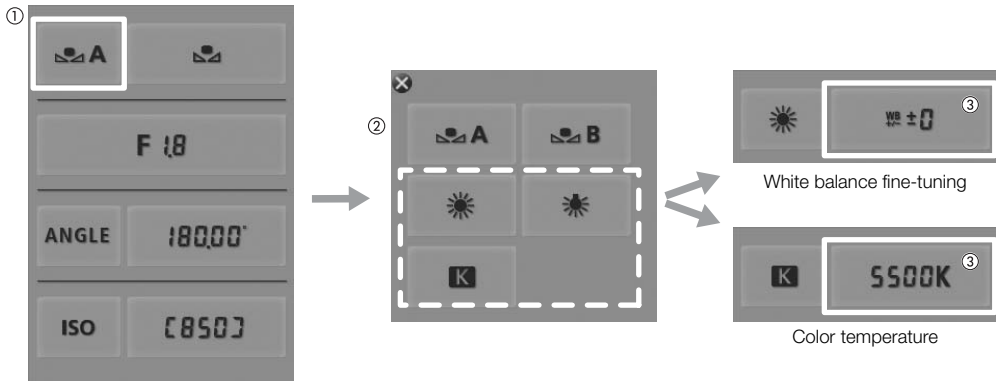

If you selected A or B:

3 Point the camera at a white object so that it fills the whole screen.

- Use the same lighting conditions you plan to use when recording.
- Make sure the white object fills the screen until the procedure is completed.

4 Press [].

- If a custom white balance has not yet been stored, [] will flash slowly.
- During the procedure, [] will flash quickly. When it stops flashing, the procedure is completed and the setting will be applied on the camera.

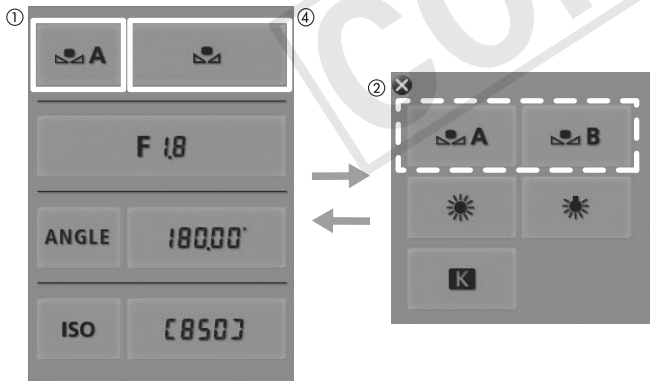

NOTES

• **Using the custom white balance setting:**

- Readjust the custom white balance if you turn the ND filter on/off or when the light source has changed.
- Very rarely and depending on the light source, may keep flashing (it will change to a slow flashing). You can still use the setting even in such case.

## Adjusting the Focus

The camera does not have automatic focus control and focusing is done manually using the focus ring on the attached lens. Nevertheless, the camera offers focus assistance functions to help you adjust the focus more accurately.

**C500** only: You can adjust the focus of an attached EF lens remotely using the Wi-Fi Remote application.

Operating modes: CAMERA MEDIA | 4K 2K MXF

### Adjusting the Focus Manually

Turn the focus ring on the attached lens to adjust the focus.

- 1 If the attached lens is equipped with an automatic focus function, set the lens to manual focus mode in advance.
  - Refer to the instruction manual of the lens used.
- 2 Turn the focus ring to adjust the focus.
  - **C500** Set the focus mode switch of the EF lens to MF in advance.

#### **i** NOTES

- **C500** On some EF lenses, you can turn the focus ring to adjust the focus even when focus mode switch is set to AF.

### **C500** Remote Operation Using Wi-Fi Remote

After completing the necessary preparations (📖 49) you can adjust the focus remotely from a Wi-Fi-enabled device using the Wi-Fi Remote application.

- 1 Set the focus mode switch on the EF lens to AF (autofocus) mode.
- 2 Press one of the focus controls to adjust the focus as necessary.
  - Press one of the controls on the [NEAR] side to focus closer or one of the controls on the [FAR] side to focus farther away.
  - There are three levels of adjustment - [ < ]/[ > ] is the smallest and [ <<< ]/[ >>> ] the largest.

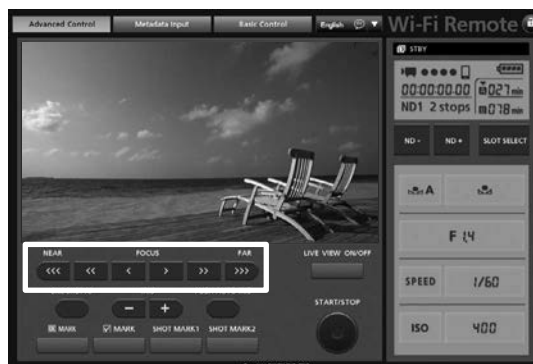

**i** NOTES

- If the focus mode switch on the EF lens is set to MF, you will not be able control the focus through remote operation. Depending on the lens used, remote operation may not work correctly.
- If you operate the zoom after focusing, the focus on the subject may be lost.
- If you focus manually and then leave the camera with the power turned on, the focus on the subject may be lost after a while. This possible slight shift in focus is a result of the internal temperature rising in the camera and lens. Check the focus before resuming shooting.
- While the camera is focusing, do not touch the end of the lens or focus ring while they are moving.

### Using the Focus Assistance Functions

In order to focus more accurately, you can use two focus assistance functions – peaking, which creates a clearer contrast by emphasizing the outlines of the subject, and magnification, which enlarges the image on the screen. You can use both functions simultaneously for greater effect.

You can also use the [F. Assist. B&W] setting (122) to switch the screen and output from the MON. terminals to black & white while using the focus assistance functions.

#### Peaking

The camera offers two peaking levels to help you focus more accurately.

- 1 Press the PEAKING button.
  - The peaking icon (PEAK1 or PEAK2) appears at the lower center of the screen and the outlines in the image on the screen will be emphasized, depending on the focus.
  - Press the button again to turn off peaking.
  - Alternatively, you can use the [LCD/VF Setup] [Peaking] setting to turn peaking on and off.
- 2 Open the [Select] submenu (under [Peaking]) to select the peaking level.
 

[LCD/VF Setup] [Select] (under [Peaking])
- 3 Select the desired level and then press SET.
  - You can use the [LCD/VF Setup] [Peaking 1] and [Peaking 2] [Color], [Gain] and [Frequency] settings to set the color, gain and frequency of the two peaking levels independently of each other. However, only [Color] will be applied to an external monitor connected to the MON. 1 terminal. Perform the following procedure to adjust the peaking gain on an external monitor.

#### To adjust the peaking gain on an external monitor

- 1 Open the [Peaking Gain] submenu.
 

[4K/2K/MXF Setup] [MON. 1] [Peaking Gain]
- 2 Push the joystick up/down or turn the SELECT dial to set the level and then press SET.

#### Magnification

- 1 Press the MAGN. button.
  - **MAGN.** appears at the lower center of the screen and the center of the picture is magnified approximately 2 times\*.
  - A white frame representing the whole screen area is displayed on the top left of the screen. The orange frame within it represents the approximate part of the image shown magnified.

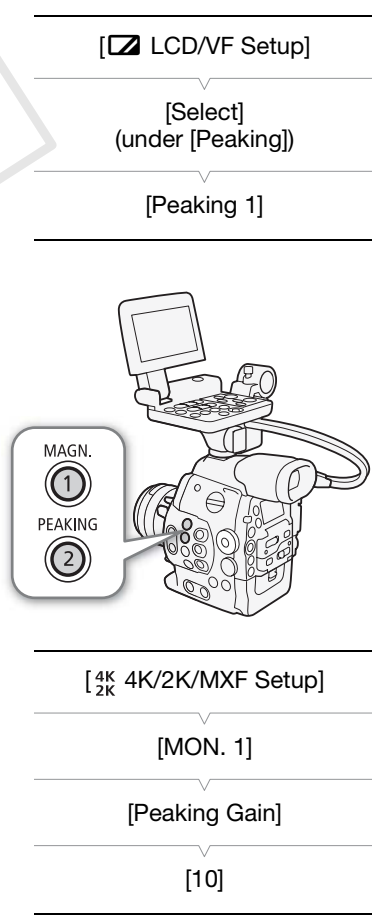



2 If necessary, use the joystick (▲▼◀▶) or SELECT dial to move the orange frame around and check other parts of the image.

- You can move the orange frame 5 steps vertically or horizontally. Press the CANCEL button to return the magnification frame to the center position.

3 Press the button again to cancel the magnification.

\* The magnification that appears on the LCD screen, viewfinder screen and external monitor is different. The magnification also differs based on the video configuration.

### **i** NOTES

- Peaking appears on the camera screen and an external monitor connected to the MON. 1 terminal. Magnification appears on the camera screen and an external monitor connected to the MON.1 or MON. 2 terminal. They will not appear when using the other terminals.
- Peaking/Magnification will not affect recordings made on a CF card.
- **When using the camera's screen to focus:**
  - The camera features professional video scopes (📖 100). You can display the edge monitor to help you focus even more accurately.
  - You can use peaking together with the edge monitor. In such case, the gain and frequency of the peaking effect will be adjusted automatically according to the gain settings of the edge monitor.
- You can use the [👉 Other Functions] ➡ [Custom Function] ➡ [Magn. Add. Disp.] setting to activate peaking and the edge monitor while the picture on the screen is being magnified.

# Onscreen Markers and Zebra Patterns

Using onscreen markers allows you to make sure your subject is correctly framed and is within the appropriate safe area. The zebra patterns help you identify areas that are overexposed. The onscreen displays and zebra pattern appear on the camera screen and an external monitor connected to the MON. 1 terminal. The onscreen markers and zebra pattern will not affect recordings made on a CF card or the signal output from the 3G-SDI and MON. 2 terminals.

Operating modes: CAMERA MEDIA | 4K 2K MXF

## Displaying Onscreen Markers

The camera offers 5 types of onscreen markers. You can display multiple onscreen markers simultaneously.

1 Open the [Markers] submenu.

[LCD/VF Setup] [Markers]

2 Select a marker you wish to display, select [White] or [Gray] and then press SET.

- Select [Off] to turn off the selected marker.
- You can display multiple markers simultaneously. Repeat this step as necessary.
- If you selected [Safety Zone] or [Aspect Marker], continue to step 3. Otherwise, you can skip to step 4.

3 Select [Safety Zone Area] or [Aspect Ratio], select the desired option and then press SET.

4 Select [Enable], select [On] and then press SET to enable the onscreen markers.

- All of the selected onscreen markers will be displayed.
- Select [Off] to turn off all onscreen markers.

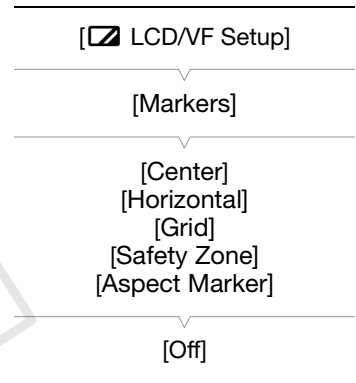

### Options

- [Center]: Displays a small marker that indicates the center of the screen.
- [Horizontal]: Displays a horizontal line to help you compose level shots.
- [Grid]: Displays a grid that allows you to frame your shots correctly (horizontally and vertically).
- [Safety Zone]: Displays indicators that show various safe areas, such as the action safe area and text safe area. Available options for [Safety Zone Area] are [80%], [90%], [92.5%] and [95%].
- [Aspect Marker]: Displays markers that indicate various aspect ratios to help you keep your shot within that area. Available options for [Aspect Ratio] are [2.35:1], [1.85:1], [1.75:1], [1.66:1], [14:9], [13:9] and [4:3].

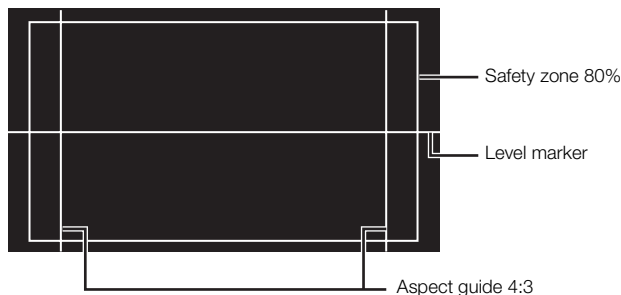

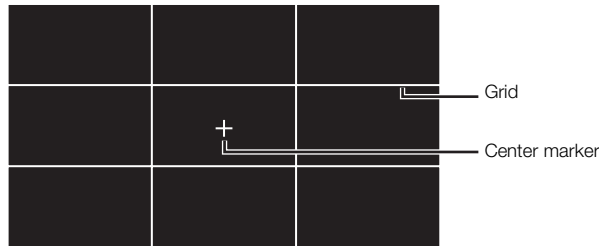

**i** NOTES

- You can turn off all onscreen displays except for the onscreen markers ( 55).
- If you set an assignable button to [Markers] ( 111), you can press the button to turn the onscreen markers on and off.
- If you selected [Side Crop] for the [4K/2K/MXF Setup] ► [MON. 1 & 2] ► [Resize Output] setting while video is output from the MON. 1 terminal:
  - The [1.85:1] aspect ratio marker will not be displayed.
  - If you select [95%] for [Safety Zone Area], the markers on the left and right side will not be displayed.

**Displaying Zebra Patterns**

The camera has a zebra pattern feature that shows black and white diagonal stripes over areas that are overexposed. The zebra patterns will not affect your recordings. There are two types of zebra patterns and you can display both simultaneously. Zebra 1 lets you identify areas within a certain range ( $\pm 5\%$  of a specified level) while zebra 2 lets you identify areas that are over a specified level. When you display both simultaneously and they overlap, only zebra 1 will be displayed in those areas.

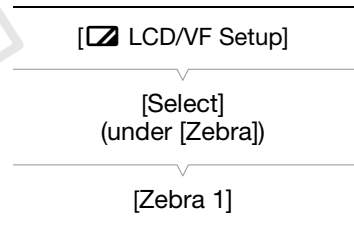

- 1 Open the zebra pattern [Select] submenu.  
[LCD/VF Setup] ► [Select] (under [Zebra])
- 2 Select [Zebra 1], [Zebra 2] or [Zebra 1&2] and then press SET.
- 3 Open the zebra level submenu.  
[LCD/VF Setup] ► [Zebra 1 Level] or [Zebra 2 Level]
- 4 Select a zebra level and then press SET.
- 5 Press the ZEBRA button to activate the selected zebra pattern.
  - Alternatively, before closing the menu, you can also select [Zebra], select [On] and then press SET.

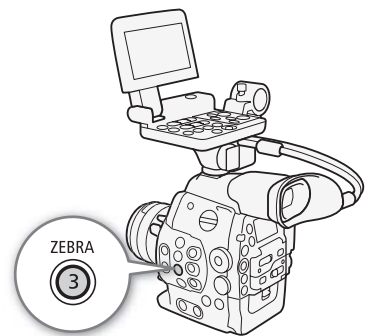

**i** NOTES

- You can use the [4K/2K/MXF Setup] ► [HD/SD Output] ► [Zebra HD Output] setting to display the zebra pattern on an external monitor connected to the HD/SD SDI terminal (HD output only), SYNC OUT terminal (HD-Y signal output only) or HDMI OUT terminal (HD output only).

## Setting the Time Code

While recording, the camera can generate a time code signal and embed it in your recordings. You can have the camera output the time code signal from the 3G-SDI terminals, MON. terminals, HD/SD SDI terminal or TIME CODE terminal (📖 91). In addition, you can superimpose the time code on video output from the HDMI OUT terminal or SYNC OUT terminal. While playing back video recorded on a CF card, you can output the time code on the CF card from the HD/SD SDI terminal or TIME CODE terminal. Additionally, you can superimpose the time code on the picture from the HDMI OUT terminal or SYNC OUT terminal. For recordings with a frame rate of 29.97P, 59.94i or 59.94P, you can also select between a drop frame and non-drop frame time code. To synchronize the camera's time code to an external time code generator, refer to *Synchronizing with an External Device* (📖 88).

Operating modes: CAMERA | MEDIA | 4K 2K MXF

### Selecting the Running Mode

During MXF mode, you can select the running mode of the camera's time code. During 4K and 2K modes, the running mode will be set to [Free Run] during normal shooting and slow & fast recording mode; it will be set to [Rec Run] during interval recording and frame recording modes. You can set the time code's initial value, however, by performing the procedure in the following section *Setting the Time Code's Initial Value*.

1 Open the time code [Mode] submenu.

[00:00 TC/UB Setup] ➤ [Time Code] ➤ [Mode]

2 Select the desired option and then press SET.

- If you selected [Regen.], you do not need to perform the rest of this procedure. If you selected [Preset] and would like to set the time code's initial value, see the following section *Setting the Time Code's Initial Value*.

3 After you select [Preset], open the time code [Run] submenu.

[00:00 TC/UB Setup] ➤ [Time Code] ➤ [Run]

4 Select the desired option and then press SET.

#### Options

[Preset]: The time code starts from an initial value you can select in advance. The default initial time code is 00:00:00.00. The time code's running mode depends on the [Run] setting.

[Rec Run]: The time code runs only while recording so clips recorded consecutively on the same CF card will have continuous time codes.

[Free Run]: The time code starts running the moment you press SET to select this option and keeps running regardless of the camera's operation.

[Regen.]: The camera will read the selected CF card and the time code will continue from the last recorded time code on the CF card. The time code runs only while recording so clips recorded consecutively on the same CF card will have continuous time codes.

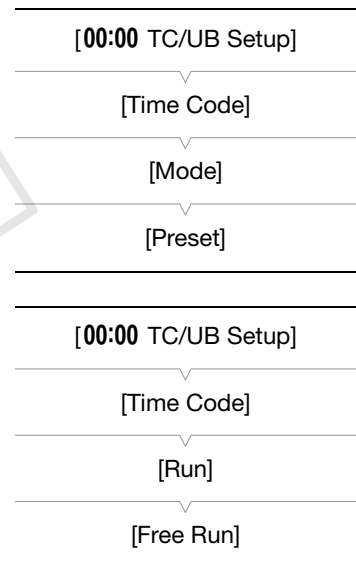

## Setting the Time Code's Initial Value

If you set the time code mode to [Preset], you can set the initial value of the time code.

- 1 Open the time code [Setting] submenu.  
[00:00 TC/UB Setup] ➤ [Time Code] ➤ [Setting]
- 2 Select [Set] and then press SET.
  - The time code setting screen appears with an orange selection frame indicating the hours.
  - To reset the time code to [00:00:00.00], select [Reset] instead. If the running mode is set to [Free Run], the time code will be reset the moment you press SET and keep running continuously from 00:00:00.00.
- 3 Use the joystick (▲▼) or SELECT dial to set the hours and press SET to move to the minutes.
- 4 Change the rest of the fields (minutes, seconds, frame) in the same way.
  - Press the CANCEL button to close the screen without setting the time code.
- 5 Select [Set] and then press SET to close the screen.
  - If the running mode is set to [Free Run], the time code will start running from the selected time code the moment you press SET.

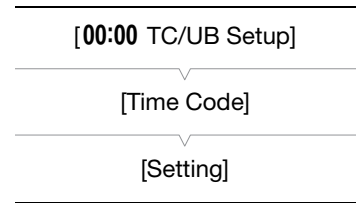

## Selecting Drop or Non-Drop Frame

When [ $\frac{4K}{2K}$  4K/2K/MXF Setup] ➤ [4K (4096/3840)], [2K (2048/1920)] or [MXF] ➤ [Frame Rate] is set to [59.94P], [59.94i] or [29.97P], you can select between a drop frame (DF) or non-drop frame (NDF) time code, depending on how you plan to use your recordings.

When [Frame Rate] is set to any other setting, the time code is set to non-drop frame (NDF) and cannot be changed.

- 1 Open the [DF/NDF] submenu.  
[00:00 TC/UB Setup] ➤ [Time Code] ➤ [DF/NDF]
- 2 Select [DF] or [NDF] and then press SET.
  - The time code display will differ depending on the setting. When you select [DF], the time code will appear as [00:00:00.00]; when you select [NDF], it will appear as [00:00:00:00].

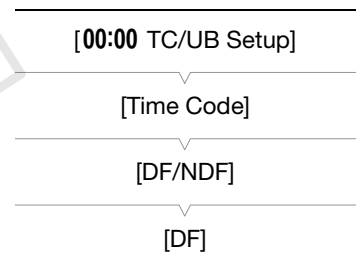

## Putting the Time Code Display on Hold

If you set an assignable button to [Time Code Hold] (📖 111), you can press the button to freeze the display of the time code\*. While the time code display is put on hold, [H] will appear on the screen next to the time code and [HOLD] will appear on the rear panel.

The time code continues to run normally while the time code display is on hold. When you resume the time code display, the current time code will be displayed.

\* The time code display from the video output terminals will be put on hold. The time code data that is superimposed on the output from the TIME CODE terminal, 3G-SDI terminals, MON. terminals and HD/SD SDI terminal will not be put on hold.

About the Time Code Display

An icon may appear next to the time code depending on the operation. Refer to the following table.

| Icon    | Description   |
|---------|---|
| R       | The time code is set to [Regen.].   |
| P       | The time code is set to [Preset] and the running mode is set to [Rec Run].  |
| F       | The time code is set to [Preset] and the running mode is set to [Free Run]. |
| E       | Time code signal is coming from an external source.                         |
| H       | Time code display is on hold.   |
| No icon | Time code during clip playback.   |

 NOTES

- When the frame rate is 23.98P or 24.00P, the frames value in the time code runs from 0 to 23. When the frame rate is 25.00P, 50.00i or 50.00P, it runs from 0 to 24. For other frame rates, it runs from 0 to 29.
- In 4K and 2K modes or when using pre-recording mode in MXF mode, [Free Run] is set automatically and cannot be changed. When you are using interval recording, frame recording or slow & fast motion recording mode, you cannot select the [Free Run] running mode.
- When you mix drop frame and non-drop frame time codes, there might be a discontinuity in the time code at the point where the recording starts.
- As long as the built-in rechargeable lithium battery is charged and you selected the [Free Run] running mode, the time code continues to run even if you disconnect all other power sources. However, this is less accurate than when the camera is on.
- If you set an assignable button to [Time Code] (📖 111), you can press the button to open the [00:00 TC/UB Setup] ➤ [Time Code] submenu.

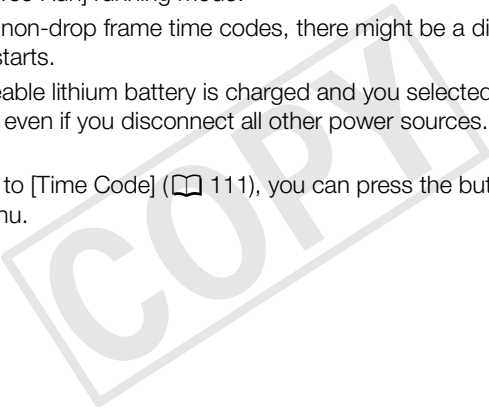

## Setting the User Bit

The user bit display can be selected from the date or the time of recording, or an identification code consisting of 8 characters in the hexadecimal system. There are sixteen possible characters: the numbers 0 to 9 and the letters A to F.

If user bit information is being received along with an external time code, you can also record the external user bit on the recording media. The user bit information can be output from the 3G-SDI terminals, MON. terminals and HD/SD SDI terminals.

Operating modes: CAMERA MEDIA | 4K 2K MXF

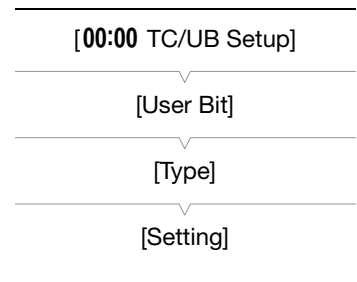

### 1 Open the user bit [Type] submenu.

[00:00 TC/UB Setup] ➤ [User Bit] ➤ [Type]

### 2 Select the desired user bit type and press SET.

- Select [Setting] to set your own identification code, [Time] to use the time as user bit, or [Date] to use the date as the user bit.
- If you selected [Time] or [Date], you do not need to perform the rest of the procedure. If you selected [Setting], continue the procedure to set the identification code.

### 3 Select [Set] and then press SET.

- The user bit setting screen appears with an orange selection frame on the leftmost digit.
- To reset the user bit to [00 00 00 00], select [Reset] instead.

### 4 Use the joystick (▲▼) or SELECT dial to select the first character and press SET to move to the next digit.

- Change the rest of the digits in the same way.
- Press the CANCEL button to close the screen without setting the user bit.

### 5 Select [Set] and then press SET to close the screen.

## Synchronizing with an External Device

Using genlock synchronization, you can synchronize this camera's video signal to that of an external video device. Similarly, using an external time code signal, you can synchronize this camera's time code to the external signal. Using the external time code signal with multiple cameras allows you to set up a multi-camera recording. You can also output the time code signal from this camera to achieve the same result. If you output the time code (while shooting) from the 3G-SDI terminals or HD/SD SDI terminal\* to an editing device, the editor can create video with the same time code.

\* The HD/SD SDI terminal can also output the time code during playback.

### Connecting an External Device

When synchronizing the camera to an external signal, input a reference video signal\* through the GENLOCK terminal or output the camera's signal as a reference signal for an external device through the SYNC OUT terminal. When synchronizing a time code signal, use the TIME CODE terminal. Be sure to set the TIME CODE terminal to input or output in advance.

Connect the external device to the camera as shown in the following diagram.

\* For the reference video signal, you can use an analog blackburst or tri-level signal.

#### Connection Diagram

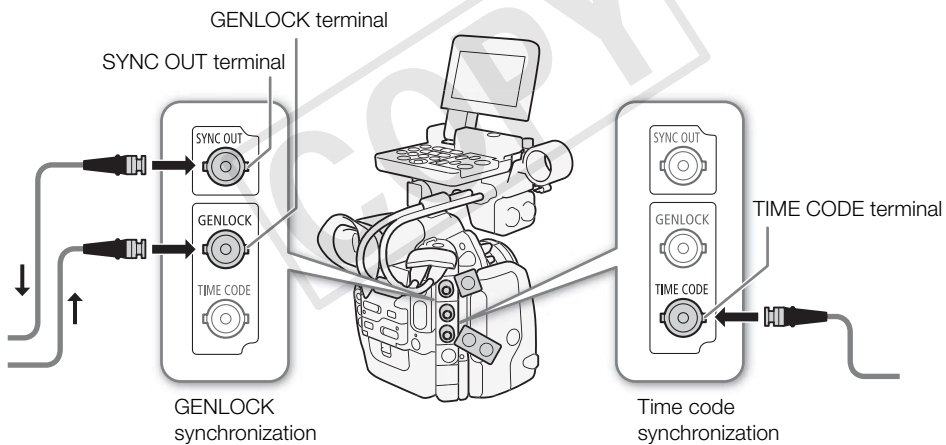

### Reference Video Signal Input (Genlock Synchronization)

When a reference sync signal (analog blackburst or tri-level signal) is input through the GENLOCK terminal, the phases of the camera's V and H sync will automatically be synchronized to it. The phase difference between the external Genlock signal and the camera is initially set to 0. The H phase can be adjusted within the range of approximately  $\pm 0.4$  H (HD equivalent).

Operating modes: CAMERA MEDIA | 4K 2K MXF

- 1 Open the [Genlock Adjust.] submenu.  
[Other Functions] [Genlock Adjust.]
- 2 Adjust the phase to the desired level, select [Set] and then press SET.
  - Use the joystick (▲▼) or SELECT dial to select the value for each field and press SET to move to the next field.

[Other Functions]

[Genlock Adjust.]



## Time Code Signal Input

An external SMPTE-standard LTC timing signal received from the TIME CODE terminal will be recorded as the time code. The user bit of the external timing signal can also be recorded. Before connecting the device, set the TIME CODE terminal to input. Also, you must set the running mode of the time code to [Free Run] (📖 84).

Operating modes: CAMERA MEDIA | 4K 2K MXF

1 Open the [TC In/Out] submenu.

[00:00 TC/UB Setup] ➤ [Time Code] ➤ [TC In/Out]

2 Select [In] and then press SET.

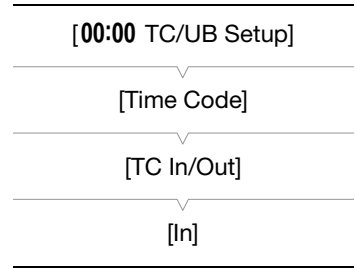

## Recording the User Bit of an External Signal

The user bit of an external time code signal can also be recorded with the time code itself.

1 Open the user bit [Rec Mode] submenu.

[00:00 TC/UB Setup] ➤ [User Bit] ➤ [Rec Mode]

2 Select [External] and then press SET.

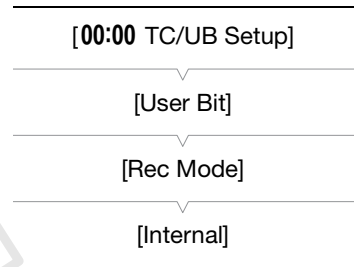

### NOTES

- The Genlock signal synchronization stabilizes after approximately 10 seconds. When the camera locks on an external Genlock signal, **Gen** will appear on the upper right of the screen.
- If the external Genlock signal is incorrect or there is no input signal, the external time code that is recorded may be incorrect.
- While a time code signal is being received, the external time code's drop-frame bit will be used (if the external time code is non-drop frame, [NDF] will appear on the rear panel).
- When an external time code signal is received, the camera's own time code will be synchronized to it and the synchronization will be maintained even if you disconnect the cable from the TIME CODE terminal. However, performing any of the following actions while the cable is not connected will cause the synchronization to be disrupted; the correct time code will be restored once you reconnect the cable.
  - Turning the camera off/on
  - Changing the operating mode to MEDIA mode
  - Changing the video configuration
- If the external time code signal is incorrect or there is no input signal, the internal time code set in the [00:00 TC/UB Setup] ➤ [Time Code] submenu will be recorded instead.
- When the camera locks on an external time code signal, [EXT-LOCK] appears on the rear panel.

## Reference Video Signal Output

You can output the camera's video signal as a reference sync signal (analog blackburst or tri-level signal) through the SYNC OUT terminal to synchronize an external device to this camera.

Operating modes: CAMERA | MEDIA | 4K | 2K | MXF

In CAMERA mode, you must first set **[00:00 TC/UB Setup]** ➤ **[Time Code]** ➤ **[24P TC/Sync]** to [Normal], which is the default setting. In MEDIA mode or if the default setting has not been changed in CAMERA mode, start from step 3 below.

1 Open the **[24P TC/Sync]** submenu.

**[00:00 TC/UB Setup]** ➤ **[Time Code]** ➤ **[24P TC/Sync]**

2 Select [Normal] and then press SET.

3 Open the **[Output]** submenu.

**[4K/2K/MXF Setup]** (in CAMERA mode) or **[Video Setup]** (in MEDIA mode) ➤ **[SYNC OUT]** ➤ **[Output]**

4 Select **[HD Sync]** (tri-level signal) or **[Blk Burst]\*** (black burst) and then press SET.

- If necessary, select [Normal] or [XF Legacy] with the **[00:00 TC/UB Setup]** ➤ **[Time Code]** ➤ **[24P TC/Sync]** setting.
- If necessary, adjust the scan mode with the **[4K/2K/MXF Setup]** ➤ **[SYNC OUT]** ➤ **[Scan Mode]** setting.

\* Not available for 24.00 Hz recordings.

CAMERA mode

**[00:00 TC/UB Setup]**

**[Time Code]**

**[24P TC/Sync]**

**[Normal]**

CAMERA mode:

**[4K/2K/MXF Setup]**

MEDIA mode:

**[Video Setup]**

**[SYNC OUT]**

**[Output]**

**[Composite]**

### Synchronization signal summary

| Video configuration for recording |  |                        |            | SYNC OUT terminal    |             |            |
|-----------------------------------|--|------------------------|------------|----------------------|-------------|------------|
| System priority                   | Recording mode                               | Resolution             | Frame rate | HD Sync <sup>1</sup> |             | Blk Burst  |
|                                   |  |                        |            | Normal <sup>2</sup>  | XF Legacy   |            |
| 4K                                | RAW  | 4096×2160<br>3840×2160 | 59.94P     | 1080/29.97 (P/PsF)   | 1080/59.94i | 480/59.94i |
|                                   |  |                        | 29.97P     |                      |             |            |
|                                   |  |                        | 23.98P     |                      |             |            |
|                                   |  |                        | 50.00P     | 1080/25.00 (P/PsF)   | 1080/50.00i | 576/50.00i |
|                                   |  |                        | 25.00P     |                      |             |            |
|                                   |  |                        | 24.00P     |                      |             |            |
| HRAW<br>4K1K RAW                  | 4096×1080<br>3840×1080*                      | 59.94P                 | 720/59.94P | 720/59.94P           | 480/59.94i  |            |
|                                   |  | 50.00P                 | 720/50.00P | 720/50.00P           | 576/50.00i  |            |
| 2K                                | <b>RGB444</b> 12-bit<br><b>RGB444</b> 10-bit | 2048×1080<br>1920×1080 | 59.94P     | 1080/29.97 (P/PsF)   | 1080/59.94i | 480/59.94i |
|                                   |  |                        | 29.97P     |                      |             |            |
|                                   |  |                        | 23.98P     |                      |             |            |
|                                   |  |                        | 50.00P     | 1080/25.00 (P/PsF)   | 1080/50.00i | 576/50.00i |
|                                   |  |                        | 25.00P     |                      |             |            |
|                                   |  |                        | 24.00P     |                      |             |            |
| <b>YCC422</b> 10-bit              | 2048×1080<br>1920×1080                       | 59.94P                 | 720/59.94P | 720/59.94P           | 480/59.94i  |            |
|                                   |  | 50.00P                 | 720/50.00P | 720/50.00P           | 576/50.00i  |            |

\* HRAW only.

| Video configuration |            |            | SYNC OUT terminal    |             |             |            |
|---------------------|------------|------------|----------------------|-------------|-------------|------------|
| System priority     | Resolution | Frame rate | HD Sync <sup>1</sup> |             |             | Blk Burst  |
|                     |            |            | CAMERA mode          |             | MEDIA mode  |            |
|                     |            |            | Normal <sup>2</sup>  | XF Legacy   |             |            |
| MXF                 | 1920×1080  | 59.94i     | 1080/59.94i          | 1080/59.94i | 1080/59.94i | 480/59.94i |
|                     |            | 29.97P     | 1080/29.97 (P/PsF)   |             |             |            |
|                     |            | 23.98P     | 1080/23.98 (P/PsF)   |             |             |            |
|                     |            | 50.00i     | 1080/50.00i          | 1080/50.00i | 1080/50.00i | 576/50.00i |
|                     |            | 25.00P     | 1080/25.00 (P/PsF)   |             |             |            |
|                     |            | 24.00P     | 1080/24.00 (P/PsF)   |             |             |            |
|                     | 1280×720   | 59.94P     | 720/59.94P           | 720/59.94P  | 720/59.94P  | 480/59.94i |
|                     |            | 29.97P     | 720/29.97P           |             |             |            |
|                     |            | 23.98P     | 720/23.98P           |             |             |            |
|                     |            | 50.00P     | 720/50.00P           | 720/50.00P  | 720/50.00P  | 576/50.00i |
|                     |            | 25.00P     | 720/25.00P           |             |             |            |
|                     |            | 24.00P     | 720/24.00P           |             |             |            |

<sup>1</sup> You can use the [00:00 TC/UB Setup] ➤ [Time Code] ➤ [24P TC/Sync] setting to select [Normal] or [XF Legacy].

<sup>2</sup> You can switch between the P and PsF setting for output.

## Time Code Signal Output

The time code will be output from the TIME CODE terminal as an SMPTE-standard LTC timing signal. The user bit will also be output. Before connecting the device, set [00:00 TC/UB Setup] ➤ [Time Code] ➤ [TC In/Out] to [Out] to change the TIME CODE terminal to output (89). The embedded time code will be output from the 3G-SDI terminals, MON. terminals and HD/SD SDI terminal.

Operating modes: CAMERA MEDIA | 4K 2K MXF

### NOTES

- The user bit of the time code signal is output while the camera is recording in CAMERA mode or during playback of a clip recorded on a CF card in MEDIA mode. For the HD/SD SDI terminal, when the frame rate is set to [23.98P] and the [00:00 TC/UB Setup] ➤ [User Bit] ➤ [Output Mode] setting is set to [Pull-down], the user bit will be 2:3 pull-down data. In other words, when a 23.98P recording is output from the HD/SD SDI terminal, the signal is converted to 59.94i using the 2:3 pull-down method. An external device can receive the data used in this conversion (2:3 pull-down data) to convert the signal to the original 23.98P specifications.

## Recording Audio

The camera features two-channel linear PCM audio recording and playback with a sampling frequency of 48 kHz. You can record audio using commercially available microphones (XLR terminal, MIC terminal) or line input (XLR terminal). You can select the audio input independently for channel 1 and channel 2.

An audio signal will be output with the video signal from the 3G-SDI terminals, MON. terminals and HD/SD SDI terminal. When you use an external recorder, the audio signal will also be recorded.

Operating modes: CAMERA MEDIA | 4K 2K MXF

### Connecting an External Microphone or External Audio Input Source to the Camera

In order to use the XLR terminals, the monitor unit must be attached to the camera. The monitor unit features two XLR terminals (CH1/CH2) that can be used to record audio independently to the two audio channels.

In addition to XLR microphones, you can also connect to the camera's MIC terminal commercially available condenser microphones with their own power supply and a  $\varnothing$  3.5 mm mini-stereo plug\*. If the monitor unit is attached to the camera, you can use the microphone holder on the monitor unit.

\* For 50.00 Hz recordings, use commercially available microphones with a cable no longer than 3 m.

Follow the procedure below to attach a microphone (refer also to the following illustration). To connect an external device to the camera, plug the device's cable into the camera's XLR terminal (④).

- 1 Loosen the microphone lock screw (①), open the microphone holder and insert the microphone (②).
- 2 Tighten the lock screw and put the microphone cable through the microphone cable clamp under the microphone holder (③).
- 3 Plug the microphone cable into the desired XLR terminal (④) or the MIC terminal (⑤).

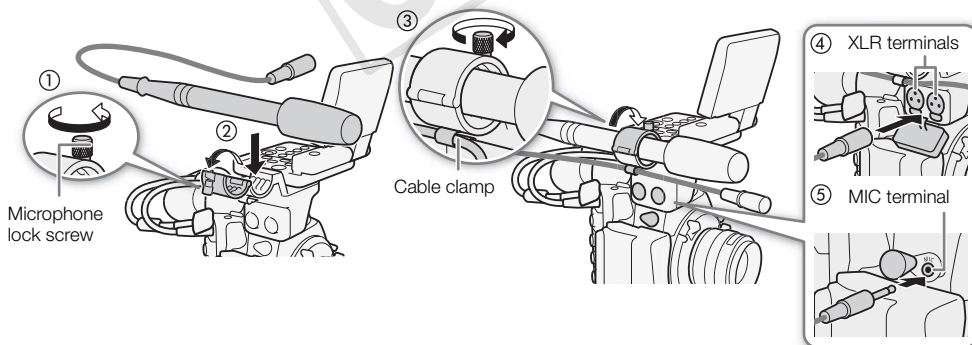

#### **i** NOTES

- Be careful not to pass the microphone cable in front of the cooling fan's air vents. Failure to do so may cause audio noise to be recorded.

## Selecting the Audio Input from the XLR Terminals

Using the XLR terminals CH1 and CH2, you can record audio independently to the two audio channels from a microphone or analog audio input source. Note that the camera's MIC terminal is given priority over the XLR terminals. To record audio from the XLR terminals, be sure not to connect any microphones to the MIC terminal.

### Switching Between Microphone and Line Input

Set the XLR terminal switch of the desired channel to **LINE** or **MIC**.

- To supply a microphone with phantom power, set the switch to **MIC+48V** instead. Make sure to connect the microphone first, before turning the phantom power on. Keep the microphone connected when turning off the phantom power.
- When using the XLR terminal to record to only one channel, use the CH1 terminal.

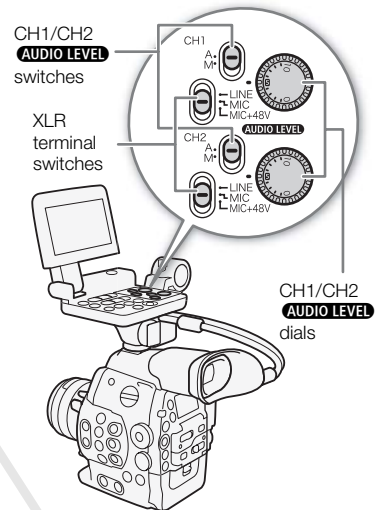

### Selecting the Recording Channel

You can select to which channel the camera will record audio.

- 1 Open the [XLR Rec Channel] submenu.  
[J) Audio Setup] ➤ [Audio Input] ➤ [XLR Rec Channel]
- 2 Select the desired option and then press SET.

#### Options

- [CH1]: Records audio to each channel separately. Audio input into CH1 is recorded to channel 1, while audio input into CH2 is recorded to channel 2.
- [CH1/CH2]: Audio input into CH1 is recorded to both channels. Audio input into CH2 will not be recorded.

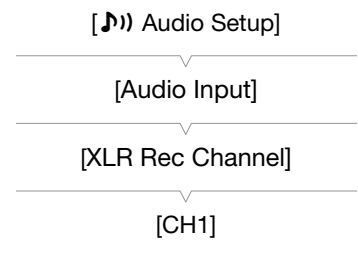

#### ! IMPORTANT

- When connecting a microphone or device that does not support phantom power, make sure to set the XLR terminal switch to **MIC** or **LINE**, respectively. If you set the switch to **MIC+48V**, the microphone or device may be damaged.

## Adjusting the Audio Level from the XLR Terminals

You can set the audio recording level for audio input from the XLR terminals to auto or manual for each channel.

### 94 Automatic Audio Level Adjustment

Set the **AUDIO LEVEL** switch of the desired channel to A (automatic) to let the camera automatically adjust that channel's audio level.

#### **i** NOTES

- When both CH1 and CH2 are set to the same audio input (external microphone or external line input), if the audio level is set to automatic, you can use the [M] Audio Setup] ➤ [Audio Input] ➤ [XLR ALC Link] setting to link the audio level adjustment of both channels.

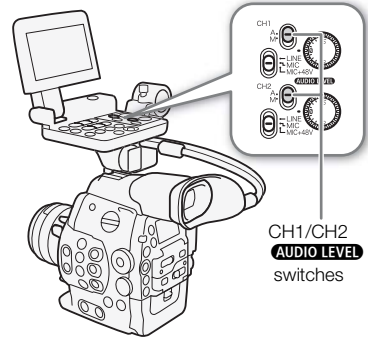

### Manual Audio Level Adjustment

You can set the audio level for each channel manually from  $-\infty$  to 18 dB.

- 1 Set the **AUDIO LEVEL** switch of the desired channel to M.
- 2 Turn the corresponding **AUDIO LEVEL** dial to adjust the audio level.
  - For reference, the 0 corresponds to  $-\infty$ , 5 corresponds to 0 dB, and 10 corresponds to +18 dB.
  - As a guideline, adjust the audio recording level so that the audio level meter on the screen or rear panel will go to the right of the 18 dB mark (one mark right of the 20 dB mark) only occasionally.
  - Closing the protective cover for XLR audio controls will prevent the audio controls from being changed inadvertently.

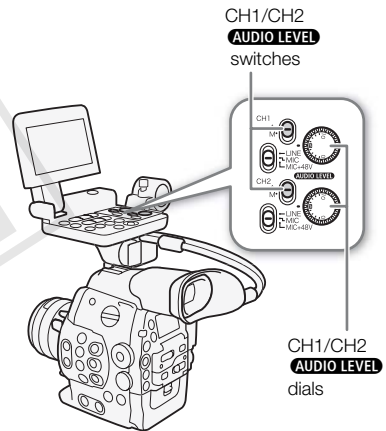

#### **i** NOTES

- If at least one of the channels is set to manual audio level adjustment, you can also activate the audio peak limiter to prevent audio distortions. When activated, the audio peak limiter will limit the amplitude of audio input signals when they exceed -4 dBFS. Use the [M] Audio Setup] ➤ [Audio Input] ➤ [Limiter] setting.
- We recommend using headphones when adjusting the audio level. If the input level is too high, audio may become distorted even if the audio level indicator shows an appropriate level.
- If you set an assignable button to [Audio Level] (📖 111), you can press the button to turn the onscreen audio level indicator on and off.

## Adjusting the Microphone's Sensitivity

You can adjust the microphone's sensitivity if the XLR terminal switch is set to MIC or MIC+48V.

- 1 Open the desired XLR terminal's sensitivity submenu.  
[🎧] Audio Setup] ➤ [Audio Input] ➤ [XLR1 Mic Trimming] or [XLR2 Mic Trimming]
- 2 Select the desired level and then press SET.

### Available Sensitivity Levels

|        |       |      |       |        |
|--------|-------|------|-------|--------|
| +12 dB | +6 dB | 0 dB | -6 dB | -12 dB |
|--------|-------|------|-------|--------|

## Activating the Microphone's Attenuator

You can activate the microphone's attenuator (20 dB) if the XLR terminal switch is set to MIC or MIC+48V.

- 1 Open the desired XLR terminal's microphone attenuator submenu.  
[🎧] Audio Setup] ➤ [Audio Input] ➤ [XLR1 Mic Att.] or [XLR2 Mic Att.]
- 2 Select [On] and then press SET.

## Adjusting the Audio Level from the MIC Terminal

You can adjust the audio recording level of a microphone attached to the MIC terminal to auto or manual. You can set the audio level manually within a range of 0 to 99.

- 1 Open the [MIC Mode] submenu.  
[🎧] Audio Setup] ➤ [Audio Input] ➤ [MIC Mode]
- 2 Select [Automatic] or [Manual] and then press SET.
  - If you selected [Automatic], you do not need to perform the rest of the procedure. If you selected [Manual], continue the procedure to set the microphone's audio recording level.
- 3 Open the [MIC Level] submenu.  
[🎧] Audio Setup] ➤ [Audio Input] ➤ [MIC Level]
- 4 Use the joystick (▲▼) or SELECT dial to set the audio recording level and then press SET.
  - As a guideline, adjust the audio recording level so that the audio level meter on the screen or rear panel will go to the right of the 18 dB mark (one mark right of the 20 dB mark) only occasionally.

### NOTES

- When adjusting the audio level manually, you can activate the audio peak limiter with the [🎧] Audio Setup] ➤ [Audio Input] ➤ [Limiter] setting. When activated, the audio peak limiter will limit the amplitude of audio input signals when they exceed -6 dBFS.
- We recommend using headphones when adjusting the audio level. If the input level is too high, audio may become distorted even if the audio level indicator shows an appropriate level.
- If you set an assignable button to [Audio Level] (🗨 111), you can press the button to turn the onscreen audio level indicator on and off.

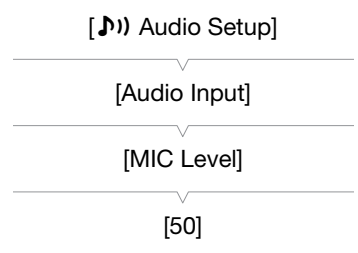
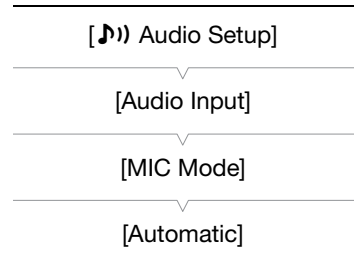
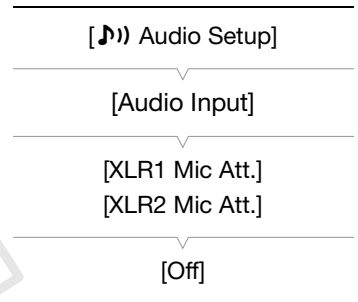
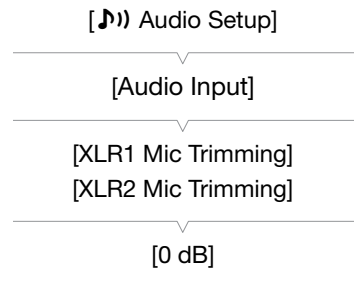

### Activating the Microphone's Attenuator

If the audio level is too high and the sound sounds distorted, activate the microphone attenuator (20 dB).

- 1 Open the [MIC Att.] submenu.  
[J) Audio Setup] ➤ [Audio Input] ➤ [MIC Att.]
- 2 Select [On] and then press SET.

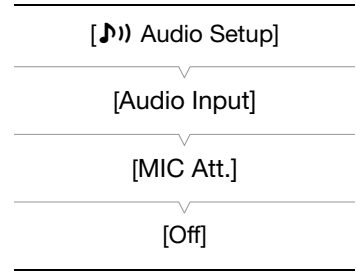

### Monitoring the Audio with Headphones

Connect headphones\* to the ♪ (headphone) terminal to monitor the recorded audio. You can adjust the headphone volume with the [J) Audio Setup] ➤ [Audio Output] ➤ [Headphone Volume] setting.

\* For 50.00 Hz recordings, use commercially available headphones with a cable no longer than 3 m.

### Selecting the Audio Channel

You can select the audio channel that is output from the ♪ (headphone) terminal.

Operating modes: CAMERA MEDIA | 4K 2K MXF

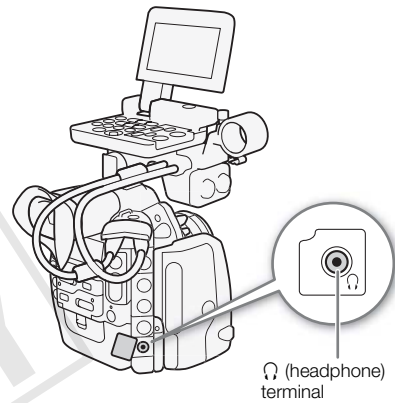

- 1 Open the [Channel] submenu.  
[J) Audio Setup] ➤ [Audio Output] ➤ [Channel]
- 2 Select the desired option and then press SET.

#### Options

- [CH1/CH2]: Audio from CH1 is output from the left audio channel and audio from CH2 is output from the right audio channel.
- [CH1/CH1]: Audio from CH1 is output from both the left and right audio channels.
- [CH2/CH2]: Audio from CH2 is output from both the left and right audio channels.
- [All/All]: Audio from CH1 and CH2 is mixed and output from both the left and right audio channels.

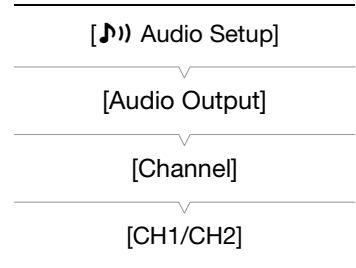

### **i** NOTES

- If you set an assignable button to [Audio Output CH] (📖 111), you can press the button to change the audio channel directly.



## Using Metadata

The camera automatically adds metadata to MXF clips, which are recorded on a CF card. You can use the supplied **Canon XF Utility** software to check and search for specific metadata. You can also create and transfer a user memo remotely using the Wi-Fi Remote application (📖 49).

### Metadata Components

| Metadata  | Entering content |                  |              | Checking content |
|---|------------------|------------------|--------------|------------------|
|   | Camera           | Canon XF Utility | Wi-Fi Remote | Canon XF Utility |
| User Memo: clip title, creator, location and description.   | –                | ● <sup>1</sup>   | ●            | ●                |
| GPS information: altitude, latitude and longitude.  | –                | ● <sup>2</sup>   | ●            | ●                |
| Recording data: Shutter speed, ISO speed/gain value, etc.   | – <sup>3</sup>   | –                | –            | ●                |
| Unique Material Identifiers (UMID): country, organization and user codes based on the SMPTE standard. | ●<br>(📖 172)     | –                | –            | –                |

<sup>1</sup> User memo files need to be created using the software and saved on the SD card in advance.

<sup>2</sup> Can only be added to clips already recorded.

<sup>3</sup> Recording data is logged automatically by the camera.

Operating modes: CAMERA MEDIA | 4K 2K MXF

### Setting a User Memo Created with Canon XF Utility

Before you can add a user memo, you must first install the supplied **Canon XF Utility** software (📖 153). Next, create the user memo and then save it to an SD card. Once you insert the SD card in the camera and select the user memo, it will be added to clips you record.

For details on using the supplied software, refer to the instruction manual that is installed with the **Canon XF Utility** software (📖 159).

#### 1 Use **Canon XF Utility** to save a user memo to an SD card.

- For details, refer to *Managing User Memo Profiles* in the Canon XF Utility Instruction Manual.

#### 2 Insert the SD card into the SD card slot of the camera.

#### 3 Open the metadata [Setting] submenu.

[ $\frac{4K}{2K}$  4K/2K/MXF Setup] ➤ [Metadata] ➤ [Setting]

#### 4 Select [SD Card] and then press SET.

#### 5 Open the [User Memo] submenu.

[ $\frac{4K}{2K}$  4K/2K/MXF Setup] ➤ [Metadata] ➤ [User Memo]

#### 6 Select the file name of the desired user memo and then press SET.

- The **MEMO** icon appears on the right of the screen.
- Select [Off] to record clips without a user memo.

#### **i** NOTES

- After you set a user memo, do not remove the SD card while you are recording. If the SD card is removed, the user memo will not be added to the clip.
- You must set the user memo before you start recording for it to be added to the clip. You cannot change the user memo already added to a clip using the camera but you can do so with the **Canon XF Utility** software.

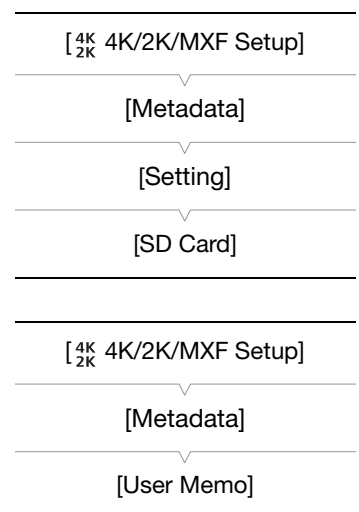

## Setting a User Memo Using Wi-Fi Remote

After completing the necessary preparations (📖 49) you create a user memo profile and transfer it to the camera from a Wi-Fi-enabled device using the Wi-Fi Remote application. Using the Wi-Fi Remote application you have two additional advantages over user memos created with **Canon XF Utility**: you can change the user memo of the last clip recorded, even if you did not specify a user memo in advance; and you can enter manually the GPS information of your shooting location.

1 Press the [Metadata Input] tab on the Wi-Fi Remote screen.

2 Press [(P)] Activate].

- Alternatively, on the camera, you can set [ $\frac{4K}{2K}$  4K/2K/MXF Setup] ➤ [Metadata] ➤ [Setting] to [Remote].

3 Fill the necessary user memo and GPS information fields.

- You can press [Clear] to clear the information entered into each field.

4 Press one of the transfer options to transfer the metadata to the camera.

- [Metadata correctly transferred] will be displayed on the Wi-Fi Remote screen and the metadata will be transferred and applied to the clips on the camera.

5 Press [X] to close the message.

### Options

[Apply from Next]: Adds the metadata you set in Wi-Fi Remote to all clips recorded after the transfer.

[Overwrite Prev.]: Only available after recording a clip. Adds the metadata you set in Wi-Fi Remote to all clips recorded after the transfer and also to the last clip recorded (overwriting any user memo that may have been recorded previously with the clip).

[Overwrite]: Only available while recording a clip. Adds the metadata you set in Wi-Fi Remote to the clip that is being recorded (overwriting any previous user memo). It will also add this metadata to all clips recorded after the transfer.



### NOTES

- The metadata sent to the camera from Wi-Fi Remote will be lost in the following cases.
  - If the camera was turned off.
  - If the [ $\frac{4K}{2K}$  4K/2K/MXF Setup] ➤ [Metadata] ➤ [Setting] setting was changed.
- Metadata sent to the camera from Wi-Fi Remote will not be added to relay clips recorded before the switch to the current CF card.

## Color Bars/Audio Reference Signal

You can have the camera generate and record color bars and/or a 1 kHz audio reference signal and output them from the 3G-SDI terminals<sup>1</sup>, MON. terminals<sup>1</sup>, HD/SD SDI terminal, HDMI OUT terminal, SYNC OUT terminal<sup>2</sup> and  (headphone) terminal<sup>1</sup>.

<sup>1</sup> Outputs audio reference signal only.

<sup>2</sup> Outputs color bars only.

Operating modes: CAMERA MEDIA | 4K 2K MXF

### Recording Color Bars

You can choose between SMPTE standard-definition color bars, EBU color bars and ARIB multi-format HDTV color bars.

1 Open the color bars [Type] submenu.

 Camera Setup ➤ [Color Bars] ➤ [Type]

2 Select the type of color bars and then press SET.

3 Open the [Enable] submenu to activate the color bars.

 Camera Setup ➤ [Color Bars] ➤ [Enable]

4 Select [On] and then press SET.

- The selected color bars appear on the screen and will be recorded when you press the START/STOP button.
- Turning the camera off or changing the operating mode to MEDIA mode will deactivate the color bars.
- Alternatively, if you set an assignable button to [Color Bars] ( 111), you can press the button to activate the color bars.

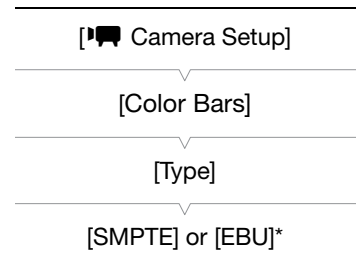

\* Depending on the country/region of purchase.

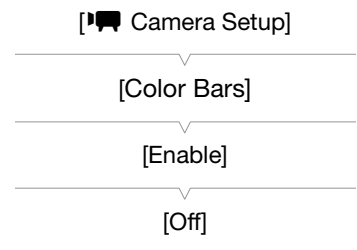

### Recording an Audio Reference Signal

The camera can output a 1 kHz audio reference signal with the color bars.

1 Open the [1 kHz Tone] submenu.

 Audio Setup ➤ [Audio Input] ➤ [1 kHz Tone]

2 Select the desired level and then press SET.

- Available levels are -12 dB, -18 dB and -20 dB.
- Select [Off] to turn off the signal.
- The signal is output at the selected level and will be recorded when you press the START/STOP button.

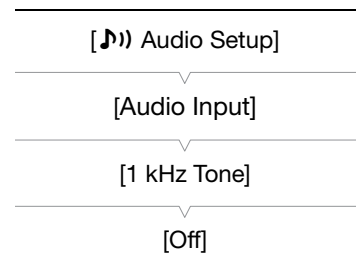

## Video Scopes

The camera can display a simplified waveform monitor or vectorscope. It can also display an edge monitor\* to help you focus. The video scopes appear only on the LCD screen. They do not appear in the viewfinder or on an external monitor. In order to use the video scopes, the monitor unit must be attached to the camera.

\* The edge monitor looks at the focus of the entire picture and displays the results as a waveform. The edge monitor is available only in **CAMERA** mode.

### Displaying a Video Scope

Press the WFM button (waveform monitor or vectorscope) or EDGE MON. button (edge monitor).

Operating modes: **CAMERA** | **MEDIA** | **4K** | **2K** | **MXF**

- The waveform monitor will appear in a window on the lower right of the screen.
- You can repeatedly press the WFM button to activate the video scopes in the following sequence.  
Waveform monitor → Vectorscope → Off
- Alternatively, you can display the video scopes using [**Other Functions**] ➤ [WFM (LCD)] ➤ [Setting]. Select [WFM] for the waveform monitor, [VS] for the vectorscope or [Edge Mon.] for the edge monitor.

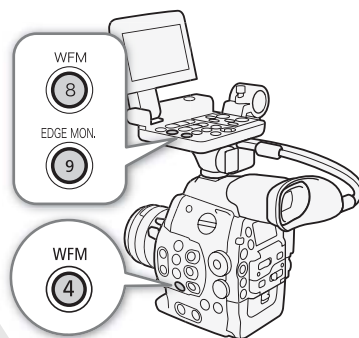

### Configuring the Waveform Monitor

The camera's waveform monitor function offers 5 modes. You can also change the gain.

Operating modes: **CAMERA** | **MEDIA** | **4K** | **2K** | **MXF**

1 Open the [Waveform Monitor] submenu.

[**Other Functions**] ➤ [WFM (LCD)] ➤ [Waveform Monitor]

2 Select the desired option and then press SET.

- If you do not need to change the gain, you do not need to perform steps 3 and 4.

3 Open the waveform monitor [Gain] submenu.

[**Other Functions**] ➤ [WFM (LCD)] ➤ [Gain] (under [Waveform Monitor])

4 Select [1x] or [2x] and then press SET.

#### Options

[Line]: Sets the waveform monitor to line display mode.

[Line+Spot]: The waveform of the area in the red frame is displayed in red on top of the [Line] mode waveform.

[Field]: Sets the waveform monitor to field display mode.

[RGB]: Functions like an RGB parade scope.

[YPbPr]: Functions like a YPbPr parade scope.

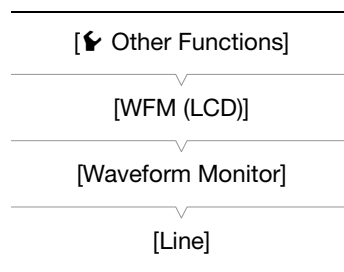

## Configuring the Vectorscope

The camera's vectorscope function offers 2 modes. You can also change the gain.

Operating modes: CAMERA MEDIA | 4K 2K MXF

1 Open the [Vectorscope] submenu.

[Other Functions] ➤ [WFM (LCD)] ➤ [Vectorscope]

2 Select the desired option and then press SET.

- If you do not need to change the gain, you do not need to perform steps 3 and 4.

3 Open the vectorscope [Gain] submenu.

[Other Functions] ➤ [WFM (LCD)] ➤ [Gain] (under [Vectorscope])

4 Select [1x] or [5x] and then press SET.

### Options

[Spot]: The color signal of the area in the red frame is displayed in red on top of the [Normal] mode waveform.

[Normal]: Displays the vectorscope.

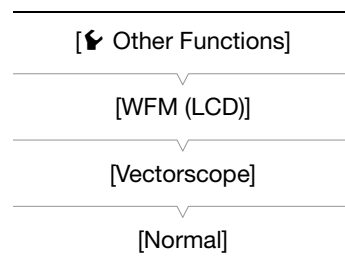

## Configuring the Edge Monitor

Using this video scope allows you to focus with more precision. You can use the edge monitor along with the other focus assistance functions (□ 80). The edge monitor features 2 modes.

Operating modes: CAMERA MEDIA | 4K 2K MXF

1 Open the [Edge Monitor] submenu.

[Other Functions] ➤ [WFM (LCD)] ➤ [Edge Monitor]

2 Select the desired option and then press SET.

- If you do not need to change the gain, you do not need to perform steps 3 and 4.

3 Open the edge monitor [Gain] submenu.

[Other Functions] ➤ [WFM (LCD)] ➤ [Gain] (under [Edge Monitor])

4 Select the desired gain value and then press SET.

### Options

[Type 1]: The waveform that represents the focus of the entire picture is displayed in green. In addition, the waveform of the area in the three red frames is displayed in red on top of the previous waveform.

[Type 2]: This mode displays the edge monitor with the waveform monitor in [Line+Spot] mode. The waveform monitor appears on the left in green while the edge monitor appears on the right in blue. The waveform of the area in the red frame is displayed in red on top of the edge monitor waveform.

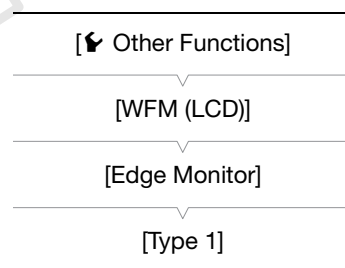

## Adding Marks while Recording MXF Clips

When recording on a CF card, you can flag an important shot in a clip by adding a “shot mark” (S1). There are two types of shot marks, shot mark 1 (S1) and shot mark 2 (S2), and you can add either or both types to a single clip. You can also add an OK mark (OK) or check mark (✓) to the entire clip to flag clips you want to set apart. You can add all four types of marks remotely using the Wi-Fi Remote application.

When the camera is in **MEDIA** mode, you can add or delete shot marks (136). You can also display an index screen of all the shot marks (135), allowing you to find a particular scene in a clip more quickly.

Operating modes: **CAMERA** **MEDIA** | **4K** **2K** **MXF**

### Adding Shot Marks while Recording

To add a shot mark to a clip while recording, you must first set in advance an assignable button to [Add Shot Mark 1] or [Add Shot Mark 2].

1 Set an assignable button to [Add Shot Mark 1] or [Add Shot Mark 2] (111).

- To add both shot marks, set one assignable button to [Add Shot Mark 1] and another assignable button to [Add Shot Mark 2].

2 While you are recording, press the assignable button at the beginning of the shot you wish to mark.

- A message indicating the short mark will appear and the selected shot mark will be added to the current frame of the clip.
- You can press the button again to add another shot mark. Up to 100 shot marks (S1 and S2 marks combined) can be added to a single clip.

### Remote Operation Using Wi-Fi Remote

After completing the necessary preparations (49) you can set a shot mark (S1 or S2) remotely from a Wi-Fi-enabled device using the Wi-Fi Remote application.

1 While recording a clip, press [SHOT MARK1] on the Wi-Fi Remote screen to set a shot mark 1 or [SHOT MARK2] to set a shot mark 2.

- [Shot Mark1] or [Shot Mark2] will be displayed on the Wi-Fi Remote screen and the shot mark will be applied to the clip.

2 Press **X** to close the message.

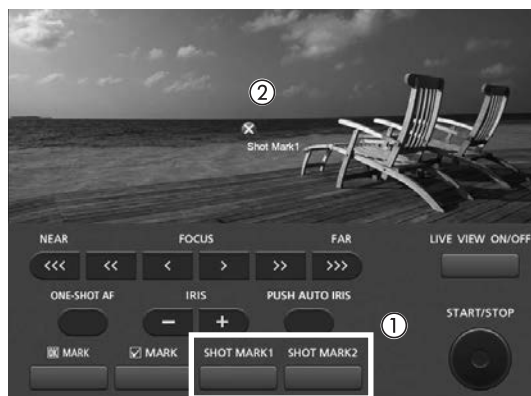

**i** NOTES

- There may be up to a 0.5 second delay from when you press the button to when the camera adds the shot mark. When using the Wi-Fi Remote application, the delay may be longer depending on the conditions of the wireless signal.
- When you are using interval recording or frame recording mode, you cannot add shot marks to a clip.
- When a clip contains either shot mark, **S** will appear next to the clip's thumbnail in the playback index screen.

### Adding an **OK** Mark or **✓** Mark to the Last Clip Recorded

After recording an important clip, you can add an OK mark (**OK**) or check mark (**✓**) to the clip to flag it and set it apart. When the camera is in **MEDIA** mode, you can display an index screen that contains only clips with an **OK** mark or only clips with a **✓** mark (126). Furthermore, you can use the **OK** mark to protect important clips, as clips with an **OK** mark cannot be deleted.

To add an **OK** mark or **✓** mark to the last clip recorded in **CAMERA** mode, you must first set in advance an assignable button to [Add **OK** Mark] or [Add **✓** Mark].

- 1 Set an assignable button to [Add **OK** Mark] or [Add **✓** Mark] (111).
  - To add both types of clip marks (to different clips), set one assignable button to [Add **OK** Mark] and another assignable button to [Add **✓** Mark].
- 2 After recording a clip, press the assignable button.
  - A message indicating the clip mark will appear and the selected clip mark will be added to the clip.

### Remote Operation Using Wi-Fi Remote

After completing the necessary preparations (49) you can set an **OK** mark or a **✓** mark remotely from a Wi-Fi-enabled device using the Wi-Fi Remote application.

- 1 After recording a clip, press [**OK** MARK] on the Wi-Fi Remote screen to set a an **OK** mark or [**✓** MARK] to set a **✓** mark.
  - [OK Mark] or [Check Mark] will be displayed on the Wi-Fi Remote screen and the mark will be applied to the clip.
- 2 Press **X** to close the message.

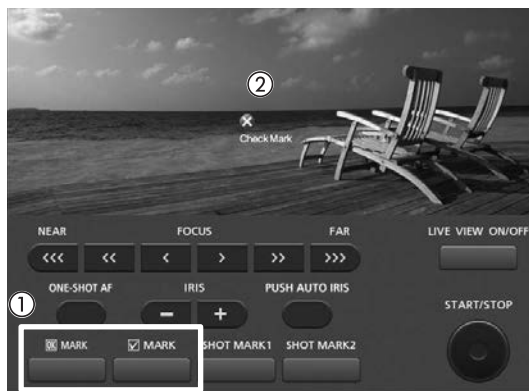

**i** NOTES

- A clip cannot have both an **OK** mark and a **✓** mark at the same time.

## Reviewing an MXF Clip

When the camera is in **CAMERA** mode, you can review the last clip that was recorded on a CF card.

Operating modes: **CAMERA** | **MEDIA** | **4K** | **2K** | **MXF**

1 Open the **[Rec Review]** submenu to set the review length.

**[Other Functions]** **[Rec Review]**

2 Select the desired option and then press **SET**.

3 After you finish recording, press the **[G]** button.

- The last clip that was recorded is played back without audio for the selected duration. **[REVIEW]** appears at the top of the screen.
- Press the **CANCEL** button to stop reviewing the clip and change the camera back to record pause mode.
- After the clip finishes playing back, the camera returns to record pause mode.

### Options

**[Entire Clip]:** Allows you to review the entire clip.

**[Last 4 sec]:** Allows you to review just the last 4 seconds of the clip.

### **i** NOTES

- When you are using a special recording mode (105), you cannot review a clip.
- If the camera switched CF cards during a recording, the camera will play back the clip on the CF card most recently recorded on.

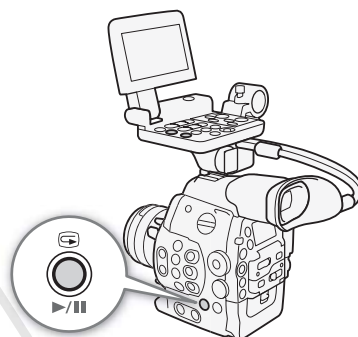
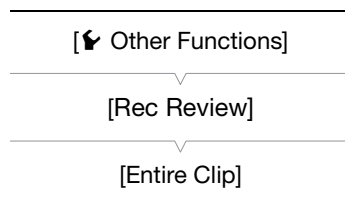

COPY



## Special Recording Modes

The camera features 4 special recording modes.

Interval recording ([Interval Rec]): A pre-defined number of frames at a pre-defined interval will be recorded automatically. This mode is suitable for recording subjects with little movement, such as natural surroundings or plants.

Frame recording ([Frame Rec]): A pre-defined number of frames will be recorded every time you press the START/STOP button. This mode is suitable for recording stop motion animation.

Slow & fast motion recording ([Slow & Fast Motion]): This mode allows you to change the shooting frame rate to achieve a slow motion or fast motion effect during playback.

Pre-recording ([Pre Rec]): The camera will start recording approximately 3 seconds before you press the START/STOP button. This is especially useful when it is difficult to predict when to start recording. Pre-recording is available only in MXF mode.

### Interval Recording Mode

Set the interval and number of frames in advance. Sound is not recorded in this mode. During 4K and 2K modes, MXF clips will not be recorded simultaneously on a CF card even if a card is inserted in the camera.

Operating modes: CAMERA MEDIA | 4K 2K MXF

#### Configuring Interval Recording Mode

- 1 Open the [Interval] submenu.  
[ $\frac{4K}{2K}$  4K/2K/MXF Setup] ➤ [Interval Rec] ➤ [Interval]
- 2 Select the desired interval and then press SET.
  - See the following table for the available intervals.
- 3 Select [Rec Frames], select the desired number of frames and then press SET.

#### Available Intervals

|        |        |        |        |        |        |        |       |       |
|--------|--------|--------|--------|--------|--------|--------|-------|-------|
| 1 sec  | 2 sec  | 3 sec  | 4 sec  | 5 sec  | 6 sec  | 7 sec  | 8 sec | 9 sec |
| 10 sec | 15 sec | 20 sec | 30 sec | 40 sec | 50 sec | 1 min  | 2 min | 3 min |
| 4 min  | 5 min  | 6 min  | 7 min  | 8 min  | 9 min  | 10 min |       |       |

#### Number of Frames Recorded

| System priority | Frame rate                     | Frames recorded |
|-----------------|--------------------------------|-----------------|
| 4K              | Any                            | 1, 3, 6, 9      |
| 2K              |                                |                 |
| MXF             | 59.94i, 29.97P, 23.98P, 24.00P |                 |
|                 | 59.94P, 50.00i, 50.00P, 25.00P | 2, 6, 12        |

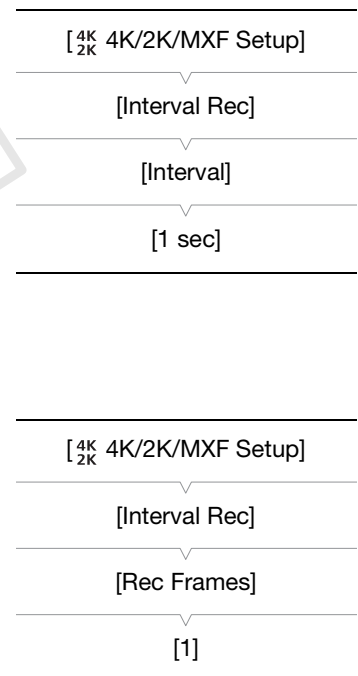

### Activating Interval Recording Mode and Recording

1 Open the [Special Rec] submenu.

[<sup>4K</sup>/<sub>2K</sub> 4K/2K/MXF Setup] ➤ [Special Rec]

2 Select [Interval Rec] and then press SET.

- [INT STBY ➔] (during 4K and 2K modes) or [INT STBY] (during MXF mode) appears at the top of the screen (with [INT] flashing).

3 Press the START/STOP button to begin recording.

- The set number of frames are recorded automatically at the set interval.
- The tally lamp illuminates.
- [INT] changes to [● INT] while recording frames.

4 Press the START/STOP button again to stop recording.

- All of the recorded frames are joined together into one clip.
- [INT STBY ➔] (during 4K and 2K modes) or [INT STBY] (during MXF mode) appears at the top of the screen (with [INT] flashing).
- The tally lamp goes out.

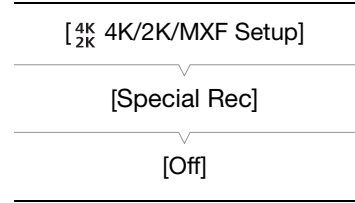

### **i** NOTES

- You can use only one special recording mode at a time.
- While recording, you cannot change the interval or number of frames.
- Some frames at the point the recording was stopped may be recorded and added to the end of the clip.
- Interval recording mode will be deactivated if the special recording mode is changed or turned off. It will be deactivated also if you change the video configuration.
- During this special recording mode, the running mode of the time code (📖 84) can be set to [Rec Run] or [Regen.]\*. The time code advances by the number of frames recorded. If the running mode of the time code (📖 84) is set to [Free Run] or the time code is input from an external source, the running mode will switch to [Rec Run] during special recording mode. When special recording mode is deactivated, the running mode will return to its previous setting.
- During special recording mode, the time code signal will not be output from the MON. terminals, TIME CODE terminal or HD/SD SDI terminal. During 4K and 2K modes, the time code signal will be output from the 3G-SDI terminals.

\* During MXF mode only.

### Frame Recording Mode

Set the number of frames in advance. We recommend operating the camera remotely or stabilizing the camera, for example, on a tripod. Sound is not recorded in this mode. During 4K and 2K modes, MXF clips will not be recorded simultaneously on a CF card even if a card is inserted in the camera.

Operating modes: CAMERA | MEDIA | 4K 2K MXF

## Configuring Frame Recording Mode

- 1 Open the [Rec Frames] submenu.  
 [4K/2K 4K/2K/MXF Setup] ➤ [Frame Rec] ➤ [Rec Frames]
- 2 Select the desired number of frames and then press SET.

### Number of Frames Recorded

| System priority | Frame rate                     | Frames recorded |
|-----------------|--------------------------------|-----------------|
| 4K              | Any                            | 1, 3, 6, 9      |
| 2K              |                                |                 |
| MXF             | 59.94i, 29.97P, 23.98P, 24.00P |                 |
|                 | 59.94P, 50.00i, 50.00P, 25.00P | 2, 6, 12        |

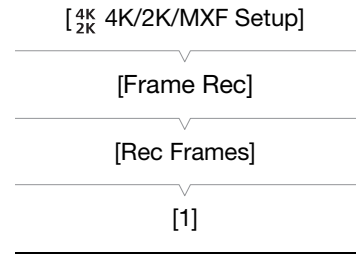

## Activating Frame Recording Mode and Recording

- 1 Open the [Special Rec] submenu.  
 [4K/2K 4K/2K/MXF Setup] ➤ [Special Rec]
- 2 Select [Frame Rec] and then press SET.
  - [FRM STBY ➤] (during 4K and 2K modes) or [FRM STBY] (during MXF mode) appears at the top of the screen (with [FRM] flashing).
- 3 Press the START/STOP button to begin recording.
  - The set number of frames are recorded automatically.
  - The tally lamp illuminates.
  - [FRM] changes to [● FRM].
  - Repeat until you finish recording.
- 4 Open the [Special Rec] submenu.  
 [4K/2K 4K/2K/MXF Setup] ➤ [Special Rec]
- 5 Select [Off] and then press SET.
  - Frame recording mode ends and all of the recorded frames are joined together into one clip.
  - [STBY ➤] (during 4K and 2K modes) or [STBY] (during MXF mode) appears at the top of the screen.
  - The tally lamp goes out.

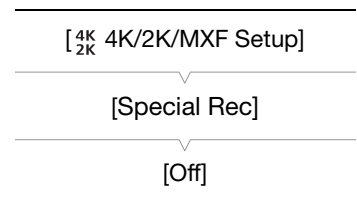

### NOTES

- You can use only one special recording mode at a time.
- While recording, you cannot change the number of frames.
- Some frames at the point the recording was stopped may be recorded and added to the end of the clip.
- Frame recording mode will be deactivated if the special recording mode is changed or turned off. It will be deactivated also if you change the video configuration.
- During this special recording mode, the running mode of the time code (□ 84) can be set to [Rec Run] or [Regen.]\*. The time code advances by the number of frames recorded. If the running mode of the time code (□ 84) is set to [Free Run] or the time code is input from an external source, the running mode will switch to [Rec Run] during special recording mode. When special recording mode is deactivated, the running mode will return to its previous setting.
- During special recording mode, the time code signal will not be output from the MON. terminals, TIME CODE terminal or HD/SD SDI terminal. During 4K and 2K modes, the time code signal will be output from the 3G-SDI terminals.  
 \* During MXF mode only.

## Slow & Fast Motion Mode

When you set the the frame rate to a progressive frame rate (📖 60), the camera can record with a frame rate (shooting frame rate) that is different from the playback frame rate. Recording a clip at a higher frame rate than the [Frame Rate] setting will result in a slow motion effect during playback (up to 1/2.5 of the original speed). Conversely, a lower frame rate will result in a fast motion effect (up to 60x the original speed). Sound is not recorded in this mode. During 4K and 2K modes, MXF clips will not be recorded simultaneously on a CF card even if a card is inserted in the camera.

Operating modes: CAMERA MEDIA | 4K 2K MXF

### Configuring Slow & Fast Motion Mode

- Open the [S&F Frame Rate] submenu.
  - [4K/2K 4K/2K/MXF Setup] ➤ [S&F Frame Rate]
- Select the desired shooting frame rate and then press SET.
  - Available shooting frame rates depend on other video configuration settings in use.

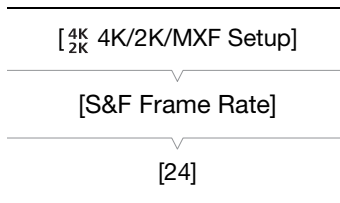

### Available Shooting Frame Rates

| System priority | Video configuration               |  | Shooting frame rate (fps, in 1 fps unless otherwise noted) |
|-----------------|-----------------------------------|--|--|
|                 | System frequency                  | Recording mode/<br>Vertical resolution |  |
| 4K<br>2K        | 59.94 Hz<br>24.00 Hz <sup>1</sup> | RAW<br>RGB444 12-bit<br>RGB444 10-bit  | 1 to 30<br>32 to 60 (in 2 fps increments) <sup>2</sup>     |
|                 |                                   | 4K1K RAW<br>HRAW<br>YCC422             | 1 to 60<br>62 to 120 (in 2 fps increments) <sup>2</sup>    |
|                 | 50.00 Hz                          | RAW<br>RGB444 12-bit<br>RGB444 10-bit  | 1 to 25<br>26 to 50 (in 2 fps increments) <sup>2</sup>     |
|                 |                                   | 4K1K RAW<br>HRAW<br>YCC422             | 1 to 50<br>52 to 100 (in 2 fps increments) <sup>2</sup>    |
| MXF             | 59.94 Hz<br>24.00 Hz              | 1080                                   | 1 to 30  |
|                 |                                   | 720                                    | 1 to 60  |
|                 | 50.00 Hz                          | 1080                                   | 1 to 25  |
|                 |                                   | 720                                    | 1 to 50  |

<sup>1</sup> The recording mode cannot be set to [HRAW], [4K1K RAW] or [YCC422] for this system frequency.

<sup>2</sup> This range is in 2 fps increments. When the shooting frame rate appears in brackets on the screen, this indicates that both 3G-SDI terminals are required for output.

### Activating Slow & Fast Motion Mode and Recording

- Open the [Special Rec] submenu.
  - [4K/2K 4K/2K/MXF Setup] ➤ [Special Rec]
- Select [Slow & Fast Motion] and then press SET.
  - [S&F STBY ➤] (during 4K and 2K modes) or [S&F STBY] (during MXF mode) appears at the top of the screen.
  - The selected shooting frame rate appears on the right of the screen next to the frame rate setting (the playback frame rate).

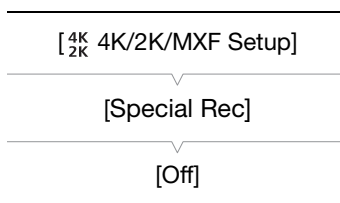



- 3 Press the START/STOP button to begin recording.
  - The tally lamp illuminates.
  - [S&F] changes to [● S&F] while recording.
- 4 Press the START/STOP button again to stop recording.
  - A clip is recorded at the set frame rate.
  - [S&F STBY➡] (during 4K and 2K modes) or [S&F STBY] (during MXF mode) appears at the top of the screen.
  - The tally lamp goes out.

### Setting the Shooting Frame Rate from the Shooting Screen

If you set an assignable button to [S&F Frame Rate], you can conveniently set the shooting frame rate from the shooting screen without having to go through the menus.

- 1 Set an assignable button to [S&F Frame Rate] (☐ 111).
- 2 Press the assignable button.
  - The shooting frame rate will be highlighted in orange.
- 3 Push the joystick up/down or turn the SELECT dial to select the desired frame rate.
- 4 Press SET.
  - The display of the shooting frame rate will return to normal.

### **i** NOTES

- You can use only one special recording mode at a time. In addition, slow & fast motion mode cannot be used with double slot recording.
- While recording, you cannot change the shooting frame rate.
- For lower shooting frame rates, it may take approximately 1 second to stop recording.
- During special recording mode, the time code signal will not be output from the MON. terminals, TIME CODE terminal or HD/SD SDI terminal. During 4K and 2K modes, the time code signal will be output from the 3G-SDI terminals.
- Slow & fast motion mode will be deactivated if the special recording mode is changed or turned off. It will be deactivated also if you change the video configuration.
- When the bit rate in the [4K/2K/MXF Setup] ➡ [MXF] ➡ [Bit Rate/Resolution] setting is set to [50 Mbps 1920x1080] or [50 Mbps 1280x720], relay recording is not available during slow motion recording.
- During 4K and 2K modes, the running mode of the time code (☐ 84) is set to [Free Run] and cannot be changed. During MXF mode, the running mode is set to [Regen.]. The time code advances while video is recorded. If the running mode of the time code is set to [Free Run] or the time code is input from an external source, the running mode will switch to [Rec Run] during special recording mode. When special recording mode is deactivated, the running mode will return to its previous setting.

## Pre-recording Mode

When pre-recording mode is activated, the camera starts recording continuously into a temporary memory of approximately 3 seconds so when you press the START/STOP button, the clip will contain also approximately 3 seconds of video and audio recorded before you pressed the button.

Operating modes: CAMERA MEDIA | 4K 2K MXF

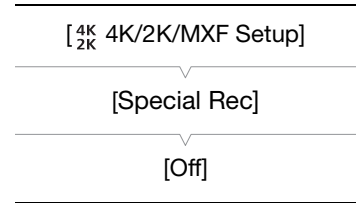

1 Set the system priority to MXF (📖 64).

2 Open the [Special Rec] submenu.

[4K/2K MXF Setup] ➤ [Special Rec]

3 Select [Pre Rec] and then press SET.

- [PRE REC STBY] appears at the top of the screen.

4 Press the START/STOP button to begin recording.

- The tally lamp illuminates.
- [PRE REC STBY] changes to [● PRE REC] while recording.

5 Press the START/STOP button again to stop recording.

- The camera records the clip, including approximately 3 seconds of video and audio recorded before the START/STOP button was pressed.
- The tally lamp goes out and [PRE REC STBY] appears at the top of the screen.

### NOTES

- You can use only one special recording mode at a time.
- Pre-recording mode will be deactivated if the special recording mode is changed or turned off. It will be deactivated also if you change the video configuration.
- During pre-recording mode, the time code will be recorded with the running mode (📖 84) set to [Free Run], regardless of the previous setting. Alternatively, you can use an external time code signal. When the time code is recorded, it will include the 3 seconds before the START/STOP button was pressed. When special recording mode is deactivated, the running mode will return to its previous setting.

## Assignable Buttons

The camera allows you to assign various functions to 15 buttons\*. By assigning often-used functions, you can quickly access them with a single press of a button. Some assignable buttons are located on the monitor unit so their availability depends on the camera configuration used.

\* In **MEDIA** mode, only assignable buttons 1 to 9 are available.

Operating modes: **CAMERA** **MEDIA** | **4K** **2K** **MXF**

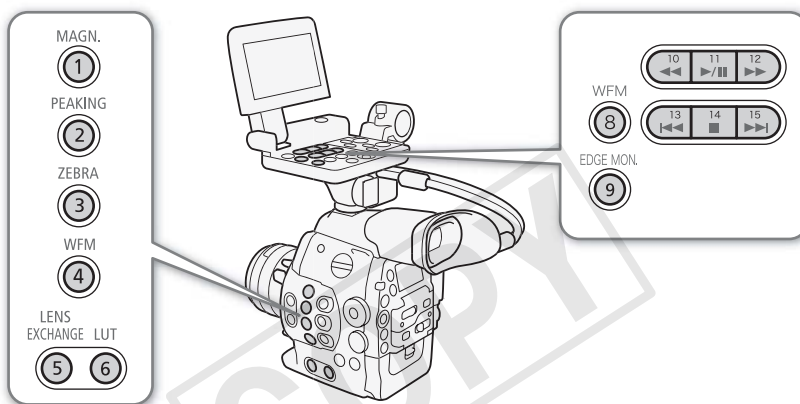

### Changing the Assigned Function

1 Open the [Assign Button] submenu.

[Other Functions] ➤ [Assign Button]

2 Select the button to change and then press SET.

- A list of available functions appears.
- The quick reference to the right shows the default settings for each assignable button. Also, the label on the camera for assignable buttons 1 to 9 indicates the default setting\*. By default, buttons 10 to 15 have no assignable function set.

\* Assignable button 7 is usable only when you attach the grip unit of the C300 / C300 PL or C100.

3 Select the desired function and then press SET.

- If you selected [User Setting (NONE)], the menu will change from orange to blue to indicate you are selecting a menu setting to register. Continue the procedure to register a menu setting. Otherwise, you do not need to perform the rest of the procedure.

4 Navigate the menus to find the menu setting you want to register and then press SET.





- The selected menu setting will be registered to the customizable slot and to the assignable button.
- The name of the selected menu setting will be listed instead of [User Setting (NONE)] and the customizable slot will be marked by a ★.

[Other Functions]

[Assign Button]

[1 MAGN.]  
 [2 PEAKING]  
 [3 ZEBRA]  
 [4 WFM]  
 [5 LENS EXCHANGE]  
 [6 LUT]  
 [7 MAGN.]  
 [8 WFM]  
 [9 EDGE MON.]  
 [10-15 (NONE)]

## NOTES











- You can check the two [Assign Button] status screens ( 182) to see what functions are set for the assignable buttons.
- You can reset the functions assigned to the assignable buttons, without affecting other camera settings, with the [ Other Functions]  [Reset]  [Assignable Buttons] function. All the assignable buttons will return to their default function.

## Using an Assignable Button

After you assign a function to one of the buttons, press the button to activate the function. For some functions, an options menu may appear. In such case, select the desired option and then press SET.

### Assignable Functions

Functions can be set separately in  mode and  mode. Refer to the following table for assignable functions and available modes.

| Function name  | Description   |  |  |  |
|--|---|--|---|---|
| [ND +]   | Cycles through the ND filter settings in order (progressively darker).  | ●  | –   | 73  |
| [ND -]   | Cycles through the ND filter settings in reverse order (progressively brighter).  | ●  | –   | 73  |
| [PEAKING]  | Turns peaking on/off.   | ●  | –   | 80  |
| [ZEBRA]  | Turns zebra patterns on/off.  | ●  | –   | 83  |
| [WFM]  | Activates video scopes in the following sequence:<br>Waveform monitor → Vectorscope → Off   | ●  | ●   | 100   |
| [EDGE MON.]  | Turns the edge monitor on/off.  | ●  | –   | 100   |
| [MAGN.]  | Turns magnification on/off.   | ●  | –   | 80  |
| [Color Bars]   | Turns color bars on/off.  | ●  | –   | 99  |
| [Markers]  | Turns onscreen markers on/off.  | ●  | –   | 82  |
| [LCD Setup]  | Opens the [LCD Setup] submenu.  | ●  | ●   | 38  |
| [VF Setup]   | Opens the [VF Setup] submenu.   | ●  | ●   | 38  |
| [LCD/VF B&W]   | Turns the B&W mode of the LCD and viewfinder on/off.  | ●  | ●   | 38  |
| [View Assist.]   | Turns view assistance on/off.   | ●  | –   | 58  |
| [LUT]  | Turns the LUT from the MON. terminals and HD/SD SDI terminals on/off.   | ●  | –   | 146   |
| [Resize MON. Output]   | Switches the resizing method of the MON. 1 terminal output in the following sequence:<br>Letterbox → Squeeze → Side Crop  | ●  | –   | 145   |
| [Resize MXF Output]  | Switches the resizing method of MXF clips in the following sequence:<br>Letterbox → Squeeze → Side Crop   | ●  | –   | 63  |
| [Onscreen Display]   | Turns on/off the inclusion of onscreen displays on video output from the HD/SD SDI terminal, HDMI OUT terminal and SYNC OUT terminal (both HD and SD video output). | ●  | ●   | 149   |
| [Add Shot Mark 1]  | Adds an  mark to the clip.   | ●  | ●   | 102   |
| [Add Shot Mark 2]  | Adds an  mark to the clip.   | ●  | ●   | 102   |
| [Add  Mark] | Adds an  mark to the clip.   | ●  | ●   | 132   |
| [Add  Mark] | Adds a  mark to the clip.  | ●  | ●   | 132   |
| [Time Code]  | Displays the [Time Code] submenu.   | ●  | –   | 84  |
| [Time Code Hold]*  | Puts the time code display on hold or resumes it.   | ●  | ●   | 85  |
| [Headphone +]  | Increases the headphone volume.   | ●  | ●   | 129   |
| [Headphone -]  | Reduces the headphone volume.   | ●  | ●   | 129   |
| [Audio Output CH]  | Switches the audio channel for audio output from the  terminal.                  | ●  | ●   | 129   |
| [Audio Level]  | Turns the audio level meter on/off.   | ●  | ●   | 94, 95  |



| Function name          | Description   | CAMERA | MEDIA |  |
|------------------------|---|--------|-------|---|
| [Photo]*               | Records a photo.  | ●      | ●     | 161   |
| [FUNC.]                | Enters the direct setting mode, replicating the function of the camera's FUNC. button.                | ●      | –     | 66  |
| [FUNC. Shutter]        | Enters the direct setting mode with the shutter speed highlighted and ready to be adjusted.           | ●      | –     | 68  |
| [FUNC. ISO/Gain]       | Enters the direct setting mode with the ISO speed or gain value highlighted and ready to be adjusted. | ●      | –     | 70  |
| [FUNC. WB]             | Enters the direct setting mode with the white balance highlighted and ready to be adjusted.           | ●      | –     | 76  |
| [S&F Frame Rate]*      | Allows you to set the shooting frame rate during slow & fast recording mode.                          | ●      | –     | 109   |
| [My Menu]              | Opens the [My Menu] customized submenu.   | ●      | –     | 30  |
| [Initialize Media]     | Opens the [Initialize Media] submenu.   | ●      | ●     | 45  |
| [LENS EXCHANGE]*       | Turns the lens exchange mode on/off.  | ●      | –     | 34  |
| [User Setting (NONE)]* | Customizable slot. Assign to the button any menu setting you would like to register.                  | ●      | ●     | –   |

\* Function can be used only by assigning it to a button.



## Custom Picture Settings

You can preset a number of picture-related settings (📖 117) for clips recorded on a CF card or video output from the various terminals (except the 3G-SDI terminals and MON. terminals). After changing individual settings to your preference, you can save the whole set in the camera or SD card as a custom picture file. You can then load the file at a later date to change the current settings to the preset levels you selected. You can even add custom picture settings to MXF clips recorded on a CF card or photos recorded on an SD card.

You can save up to 9 different custom picture files on the camera and up to 20 custom picture files on an SD card. Custom picture files can be copied between the camera and recording media.

Custom picture files created with this camera are compatible only with other C500 and C500 PL cameras.

Operating modes: CAMERA MEDIA | 4K 2K MXF

### Selecting Custom Picture Files

Select a custom picture file to apply its settings to your recordings or to edit, rename, protect, or transfer it.

1 If necessary, set [**CP** CINEMA Locked] to [Off] (📖 58).

2 Press the CUSTOM PICTURE button.

- The custom picture menu appears. The currently selected file appears next to the **SET** icon or [Off] if no file is selected.

3 Select the desired file and then press SET.

- Select [Off] to record without applying any custom picture settings.
- To apply the custom picture settings of the selected file, continue to step 4. To perform other operations on the selected file (edit settings, copy, protect, etc.), continue instead with the one of the procedures in the following pages.

4 Press the CUSTOM PICTURE button to exit the custom picture menu.

- The selected custom picture file's settings will be applied. **CP** (camcorder) or **CF** (SD card) and the custom picture file's number will appear on the left of the screen.

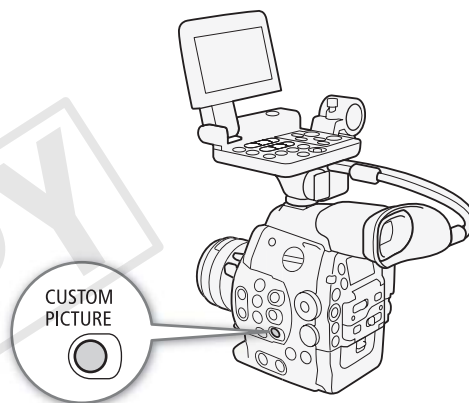

#### Preset Custom Picture Files

By default, the custom picture files in file slots [C8] and [C9] in the camera are protected. Remove the protection (📖 115) to edit the file. The following describes when to use the preset files.

[C8: CINEMA]: Uses the Canon Log gamma and color matrix for an outstanding dynamic range and an image suitable for processing in post-production.



[C9: EOS Std.]: Reproduces the image quality and look (high contrast, vibrant colors) of an EOS digital SLR camera with its picture style set to [Standard].

### Editing a Custom Picture File's Settings

1 After selecting a file, select [**CP** Edit File] and then press SET.

2 Select a setting and then press SET.



### 3 Change the setting to the desired level and then press SET.

- Refer to *Available Custom Picture Settings* (📖 117) for details on the various settings.
- Repeat steps 2 and 3 for other settings, as necessary.
- The new custom picture settings will be applied.  (camcorder) or  (SD card) and the custom picture file's number will appear on the left of the screen.

### Resetting the current file's settings to default values

- 1 Select [Reset] and then press SET.
- 2 Select the default values and then press SET.
  - Select [NEUTRAL] to reset to neutral default values (equivalent to not using custom picture settings at all) or [CINEMA] or [EOS Std.] if you want to replicate these preset settings, for example as a starting point to edit them further.
- 3 Select [OK] and then press SET.

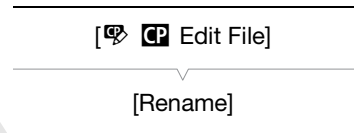

### Renaming Custom Picture Files

- 1 After selecting a file, open the [Rename] submenu.
  -   Edit File] ➤ [Rename]
  - A screen appears that displays the current file name with an orange selection frame on the first character.
- 2 Select an alphanumeric character or symbol then move (▶) to the next field.
  - Change the rest of the name in the same way.
- 3 Select [Set] and then press SET.
- 4 Press the CUSTOM PICTURE button to exit the custom picture menu.





### Protecting Custom Picture Files

Protecting a custom picture file prevents its settings from being accidentally changed.

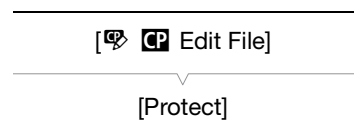



- 1 After selecting a file, open the [Protect] submenu.
  -   Edit File] ➤ [Protect]
- 2 Select [Protect] and then press SET.
  - In the custom picture menu,  will appear next to the file name.
  - To remove protection settings, select [Unprotect] instead.
- 3 Press the CUSTOM PICTURE button to exit the custom picture menu.



### Transferring Custom Picture Files



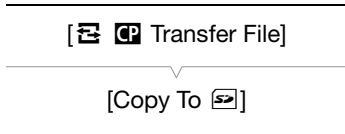

You can transfer custom picture files between the camera and SD card. When the selected custom picture file is in the camera, use [Copy To ] or [Load From ] depending on the operation you wish to perform. Similarly, when the selected custom picture file is on an SD card, use [Copy To Cam.] or [Load From Cam].

### Copying a File from the Camera to an SD Card

- 1 After selecting a file in the camera, open the [Copy To ] submenu.  
[  Transfer File] ➤ [Copy To ]
- 2 Select the file slot on the SD card under which to save the file and then press SET.
  - If there are available slots, you can select [New File] to save the file in the first available slot.
- 3 Select [OK] and then press SET.
  - The currently selected file will be copied to the selected slot on the SD card, overwriting the file in that slot. When the confirmation screen appears, press SET.
- 4 Press the CUSTOM PICTURE button to exit the custom picture menu.





### Replacing a File in the Camera with a File on an SD Card

- 1 After selecting a file in the camera to replace, open the [Load From ] submenu.  
[  Transfer File] ➤ [Load From ]
- 2 Select the file to transfer to the camera and then press SET.
- 3 Select [OK] and then press SET.
  - The file in the camera will be overwritten by the one on the SD card. When the confirmation screen appears, press SET.
- 4 Press the CUSTOM PICTURE button to exit the custom picture menu.



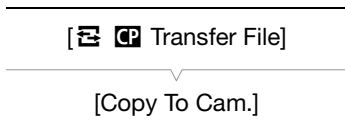

### Copying a File from an SD Card to the Camera

- 1 After selecting a file on the SD card, open the [Copy To Cam.] submenu.  
[  Transfer File] ➤ [Copy To Cam.]
- 2 Select the file slot under which to save the file and then press SET.
- 3 Select [OK] and then press SET.
  - The currently selected file will be copied to the selected slot on the camera, overwriting the file in that slot. When the confirmation screen appears, press SET.
- 4 Press the CUSTOM PICTURE button to exit the custom picture menu.



### Replacing a File on an SD Card with a File in the Camera

- 1 After selecting a file on the SD card to replace, open the [Load From Cam.] submenu.  
[  Transfer File] ➤ [Load From Cam.]
- 2 Select the file to transfer to the SD card and then press SET.
- 3 Select [OK] and then press SET.
  - The file on the SD card will be overwritten by the one on the camera. When the confirmation screen appears, press SET.
- 4 Press the CUSTOM PICTURE button to exit the custom picture menu.



#### NOTES

- You can also copy a custom picture file embedded in an MXF clip to the camera ( 134).

## Embedding Custom Picture Settings in a Recording

By default, when you record an MXF clip or take a photo with custom picture settings applied to it, the custom picture file used to record it is embedded in the image file. Later, those embedded settings in the MXF clip or photo can be copied to the camera (166) and be applied to future recordings. You may find that embedding custom picture settings in a recording helps you keep track of them, such as verifying what settings were used for a particular recording.

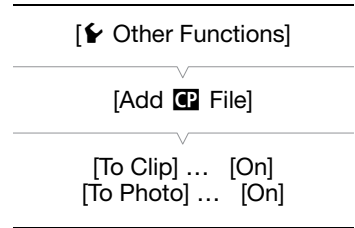

1 Open the [Add CP File] submenu.

[Other Functions] ➤ [Add CP File]

2 Select [To Clip] or [To Photo] and then press SET.

- Selecting [To Clip] will embed the custom picture file in a clip, while selecting [To Photo] will embed the file in a photo.

3 Select [On] or [Off] and then press SET.

## Available Custom Picture Settings

The following are the available settings. Even if no custom picture file is selected, the default settings are still applied to the picture.

### [Gamma]

The gamma curve changes the overall look of the image. (Default: [Normal 1]).

[Normal 1] to [Normal 4]: These settings are suitable for viewing the image on a TV monitor. Highlights in [Normal 2] are brighter than those of [Normal 1]. Dark tones in the lower part of the gamma curve for [Normal 3] (ITU-R BT.709 standard) and [Normal 4] are more pronounced than those of [Normal 2].

[Cine 1] or [Cine 2]: Use [Cine 1] for a gamma curve that results in a picture with a cinema-like feel and cinema-like tones. [Cine 2] has softer contrasts than does [Cine 1] but is also suitable for creating a cinema-like picture.

[Canon Log]: Applies a logarithmic gamma curve for outstanding dynamic range. Requires image processing in post-production.

[EOS Std.]: This gamma curve approximates the look of an EOS digital SLR camera when the picture style is set to [Standard] (high contrast, vibrant colors).

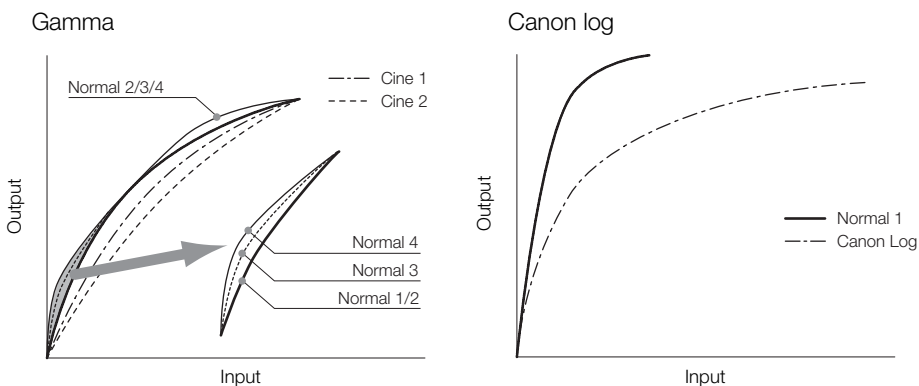

### [Black]

Controls the black level and color cast of blacks.

**[Master Pedestal]**

The master pedestal increases or decreases the black level. Higher settings will make dark areas brighter but decrease contrast. This setting can be adjusted from -50 to 50. (Default:  $\pm 0$ )

**[Master Black]**

Corrects color cast in blacks.

[Red]: -50 to 50 (Default:  $\pm 0$ )

[Green]: -50 to 50 (Default:  $\pm 0$ )

[Blue]: -50 to 50 (Default:  $\pm 0$ )

**[Black Gamma]**

Controls the lower part of the gamma curve (dark areas of the image). This setting is not available when [Gamma] is set to [Canon Log].

[Level]: Raises or lowers the lower part of the gamma curve. This setting can be adjusted from -50 to 50. (Default:  $\pm 0$ )

[Range]: Selects the range in which dark areas are affected. This setting can be adjusted from -5 to 50. (Default:  $\pm 0$ )

[Point]: Determines the shape of the lower part of the gamma curve. This setting can be adjusted from -1 to 50. (Default:  $\pm 0$ )

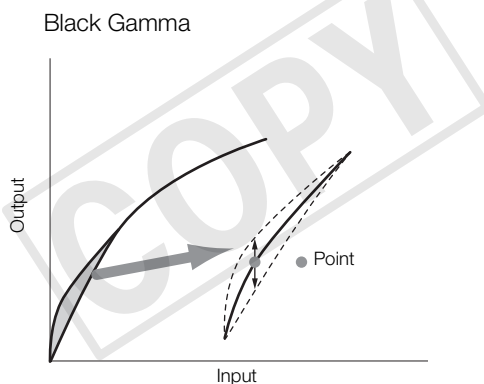

**[Low Key Satur.]**

Adjusts color saturation in dark areas.

[Enable]: Activates/deactivates the setting. (Default: [Off])

[Level]: Specifies how saturated colors are in dark areas. This setting can be adjusted from -50 to 50. (Default:  $\pm 0$ )

**[Knee]**

Controls the upper part of the gamma curve (highlights of the image). By compressing the highlights, you can prevent parts of the image from being overexposed. This is not available when [Gamma] is set to [Cine 1], [Cine 2], [Canon Log] or [EOS Std.].

[Enable]: Activates/deactivates the setting. (Default: [On])

[Slope]: Determines the slope of the gamma curve above the knee point. This setting can be adjusted from -35 to 50. (Default:  $\pm 0$ )

[Point]: Sets the knee point of the gamma curve. This setting can be adjusted from 50 to 109. (Default: 95)

[Saturation]: Adjusts color saturation in highlights. This setting can be adjusted from -10 to 10. (Default:  $\pm 0$ )

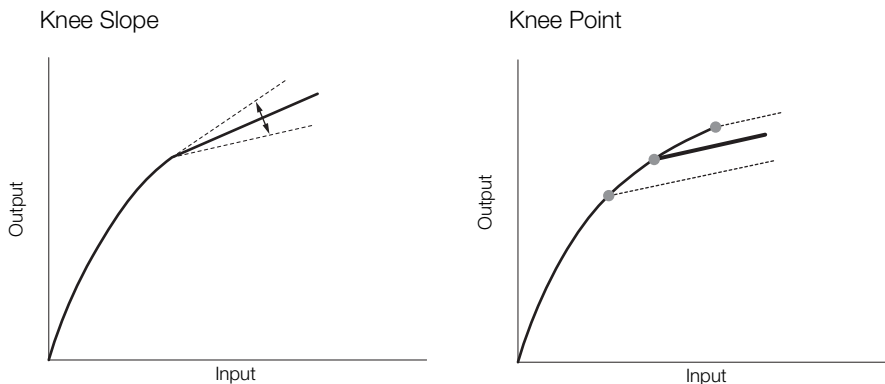
**[Sharpness]**

Sets the sharpness of the output and recording signal.

[Level]: Sets the sharpness level. This setting can be adjusted from -10 to 50. (Default:  $\pm 0$ )

[H Detail Freq.]: Sets the center frequency of horizontal sharpness. Setting higher values increases the frequency, which, in turn, increases the sharpness. This setting can be adjusted from -8 to 8. (Default:  $\pm 0$ )

[Coring]: Reduces noise artifacts caused by high sharpness levels.

[Level]: Sets the coring level. Higher values prevent sharpness from being applied to minute details, resulting in less noise. This setting can be adjusted from -30 to 50. (Default:  $\pm 0$ )

[D-Ofst]: You can use [D-Ofst], [D-Curve] and [D-Depth] to adjust the coring level based on brightness. [D-Ofst] sets the coring level of the minimum brightness level. This setting can be adjusted from 0 to 50. (Default: 0)

[D-Curve]: Sets the curve of the coring adjustment. This curve is the change from [Level] to [D-Ofst]. This setting can be adjusted from 0 to 8. (Default: 0)

[D-Depth]: Sets a multiplier to [D-Ofst] that determines the coring level adjustment based on brightness. Positive values raise the coring level in dark areas and negative values lower the level. This setting can be adjusted from -4 to 4. (Default:  $\pm 0$ )

[HV Detail Bal.]: Adjusts the ratio between horizontal and vertical detail. Higher values emphasize vertical detail while lower values emphasize horizontal detail. This setting can be adjusted from -8 to 8. (Default:  $\pm 0$ )

[Limit]: Restricts how much sharpness is applied. This setting can be adjusted from -50 to 50. (Default:  $\pm 0$ )

[Select]: In addition to the sharpness set by [Level], [Select] sets the sharpness for areas with higher frequencies. Higher values apply more sharpness to areas with higher frequencies. Use this for subjects in which normal sharpening is not effective. This setting is not available when the video configuration is 720P. This setting can be adjusted from 0 to 15. (Default: 0)

[Knee Aperture]: Allows you to set the sharpness of only the areas above the knee point by adjusting the gain and slope. When [Gamma] is set to [Cine 1], [Cine 2], [Canon Log] or [EOS Std.], this setting has no effect on the picture.

[Gain]: Sets the amount of sharpness. This setting can be adjusted from 0 to 9. (Default: 0)

[Slope]: Sets the slope of the sharpness. This setting can be adjusted from 0 to 3, with 0 having no slope, 1 having a steep slope and 3 having a gradual slope. (Default: 1)

[Level Depend]: Lowers the amount of sharpness applied to dark areas of the image.

[Level]: Sets the brightness of the dark areas of the image that will be affected. This setting can be adjusted from 0 to 50. (Default: 0)

[Slope]: Determines the slope of the area between the upper and lower parts of the gamma curve. This setting can be adjusted from 0 to 3, with 0 having no slope, 1 having a steep slope and 3 having a gradual slope. (Default: 0)

[Offset]: Adjusts the sharpness level of dark areas in the image. Setting higher values will lower the sharpness level. This setting can be adjusted from 0 to 50. (Default: 0)

#### [Noise Reduction]

Reduces the amount of noise that appears in the image. Select a level from 1 (lowest level) to 12 (highest level), or select [Off] to turn the noise reduction off. (Default: [Off])

#### [Skin Detail]

The camera applies a softening filter to areas in the picture with skin tones to give a more pleasant appearance. By changing these settings, you can determine what areas will be detected as skin tones. A zebra pattern will appear over areas on the screen that are detected as having skin tones.

[Effect Level]: Adjusts the level of the filter. The available options are [Off], [Low], [Middle] and [High]. (Default: [Off])

[Hue]: Adjusts the hue for detection of skin tones. This setting can be adjusted from -16 to 16. (Default:  $\pm 0$ )

[Chroma]: Adjusts the color saturation for detection of skin tones. This setting can be adjusted from 0 to 31. (Default: 16)

[Area]: Adjusts the color range for detection of skin tones. This setting can be adjusted from 0 to 31. (Default: 16)

[Y Level]: Adjusts the brightness for detection of skin tones. This setting can be adjusted from 0 to 31. (Default: 16)

#### [Selective NR]

The camera detects the characteristics of a certain color or tone and applies a noise reduction filter to the targeted areas. A zebra pattern will appear over targeted areas on the screen.

[Effect Level]: Adjusts the level of the noise reduction filter. The available options are [Off], [Low], [Middle] and [High]. (Default: [Off])

[Hue]: Adjusts the hue for the color to be detected. This setting can be adjusted from 0 to 31. (Default: 0)

[Chroma]: Adjusts the color saturation for the color to be detected. This setting can be adjusted from 0 to 31. (Default: 16)

[Area]: Adjusts the color range for the color to be detected. This setting can be adjusted from 0 to 31. (Default: 16)

[Y Level]: Adjusts the brightness for the color to be detected. This setting can be adjusted from 0 to 31. (Default: 16)

#### [Color Matrix]

Color matrix affects the color tones throughout the whole image. This setting is not available when [Gamma] is set to [Canon Log].

[Select]: Available options are [Normal 1] to [Normal 4], [Cine 1] and [Cine 2], [Canon Log] and [EOS Std.]. Generally, this is the same setting as [Gamma]. After selecting an option, you can make more precise adjustments. (Default: [Normal 1])

[Gain]: Adjusts the color intensity. This setting can be adjusted from -50 to 50. (Default:  $\pm 0$ )

[Phase]: Adjusts the color phase. This setting can be adjusted from -18 to 18. (Default:  $\pm 0$ )

[R-G]: The R-G matrix changes the tint of the picture along the cyan/green and red/magenta gradations. This setting can be adjusted from -50 to 50. (Default:  $\pm 0$ )

[R-B]: The R-B matrix changes the tint of the picture along the cyan/blue and red/yellow gradations. This setting can be adjusted from -50 to 50. (Default:  $\pm 0$ )

[G-R]: The G-R matrix changes the tint of the picture along the magenta/red and green/cyan gradations. This setting can be adjusted from -50 to 50. (Default:  $\pm 0$ )

[G-B]: The G-B matrix changes the tint of the picture along the magenta/blue and green/yellow gradations. This setting can be adjusted from -50 to 50. (Default:  $\pm 0$ )



- [B-R]: The B-R matrix changes the tint of the picture along the yellow/red and blue/cyan gradations. This setting can be adjusted from -50 to 50. (Default:  $\pm 0$ )
- [B-G]: The B-G matrix changes the tint of the picture along the yellow/green and blue/magenta gradations. This setting can be adjusted from -50 to 50. (Default:  $\pm 0$ )

### [White Balance]

Adjusts the amount of white balance throughout the whole image.

- [R Gain]: Adjust the intensity of red tones. This setting can be adjusted from -50 to 50. (Default:  $\pm 0$ )
- [G Gain]: Adjust the intensity of green tones. This setting can be adjusted from -50 to 50. (Default:  $\pm 0$ )
- [B Gain]: Adjust the intensity of blue tones. This setting can be adjusted from -50 to 50. (Default:  $\pm 0$ )

### [Color Correction]

The camera detects the characteristics of a certain color (color phase, chroma, area and Y level) and corrects them when recording. You can set the color correction for up to two different areas (A and B).

- [Select Area]: Selects the area or areas to correct. Available options are [Area A], [Area B] and [Area A&B]. Select [Off] to turn this setting off. (Default: [Off])
- [Area A Setting]: Determines the area in which colors will be corrected.
- [Phase]: Adjusts the color phase for area A. This setting can be adjusted from 0 to 31. (Default: 0)
  - [Chroma]: Adjusts the color saturation for area A. This setting can be adjusted from 0 to 31. (Default: 16)
  - [Area]: Adjusts the color range for area A. This setting can be adjusted from 0 to 31. (Default: 16)
  - [Y Level]: Adjusts the brightness for area A. This setting can be adjusted from 0 to 31. (Default: 16)
- [Area A Revision]: Sets the amount of correction for area A.
- [Level]: Adjusts the amount of correction to the color saturation. This setting can be adjusted from -50 to 50. (Default:  $\pm 0$ )
  - [Phase]: Adjusts the amount of correction to the color phase. This setting can be adjusted from -18 to 18. (Default:  $\pm 0$ )
- [Area B Setting]: Determines the area in which colors will be corrected.
- [Phase]: Adjusts the color phase for area B. This setting can be adjusted from 0 to 31. (Default: 0)
  - [Chroma]: Adjusts the color saturation for area B. This setting can be adjusted from 0 to 31. (Default: 16)
  - [Area]: Adjusts the color range for area B. This setting can be adjusted from 0 to 31. (Default: 16)
  - [Y Level]: Adjusts the brightness for area B. This setting can be adjusted from 0 to 31. (Default: 16)
- [Area B Revision]: Sets the amount of correction for area B.
- [Level]: Adjusts the amount of correction to the color saturation. This setting can be adjusted from -50 to 50. (Default:  $\pm 0$ )
  - [Phase]: Adjusts the amount of correction to the color phase. This setting can be adjusted from -18 to 18. (Default:  $\pm 0$ )

### [Other Functions]

- [Setup Level]: Adjusts the black level set by the [Black] and [Master Pedestal] settings.
- [Level]: Determines the amount of adjustment to be made. This setting can be adjusted from -50 to 50. (Default:  $\pm 0$ )
  - [Press]: Compresses the dynamic range of the video signal so that it does not exceed 100%. Available options are [On] and [Off]. (Default: [Off])
- [Clip At 100%]: When the video signal exceeds 100%, this function clips the white level at 100%. Available options are [On] and [Off]. (Default: [Off])

## Customizing Functions and Onscreen Displays

Customize the camera to match your shooting style and needs. Use the [👉 Other Functions] ➡ [Custom Function] setting to adjust how some of the camera's controls and functions operate in **CAMERA** mode. Similarly, use the [📺 LCD/VF Setup] ➡ [Custom Display 1] or [Custom Display 2] setting to customize the onscreen displays that appear on the screen during recording. You can save these preferences along with other menu settings to an SD card and use them again later (📖 124).

### Customizing Functions

The following table describes which functions can be customized using [Custom Function].

Operating modes: **CAMERA** | **MEDIA** | **4K** | **2K** | **MXF**

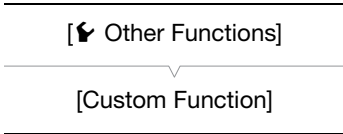

- 1 Open the [Custom Function] submenu.  
[👉 Other Functions] ➡ [Custom Function]
- 2 Select the desired function.
- 3 Change the setting option and then press SET.

#### Customizable Functions with [Custom Function]

| Menu item             | Setting options  | Description   |
|-----------------------|--|---|
| [Shockless WB]        | [On], <b>[Off]</b>   | Creates a softer transition when the white balance is changed.  |
| [Control Dial]        | <b>C500</b> [Iris], [ISO/Gain], [Off]<br><b>C500 PL</b> [ISO/Gain], <b>[Off]</b> | Selects the function of the control dial.   |
| [Grip Ctrl Dial]      | <b>C500</b> [Iris], [ISO/Gain], [Off]<br><b>C500 PL</b> [ISO/Gain], <b>[Off]</b> | Selects the function of the control dial on the grip unit of the C300 / C300 PL or C100 camcorder, which can be attached to the GRIP terminal.  |
| [Control Dial Dir.]   | [Reverse], <b>[Normal]</b>   | Changes the direction of the adjustment when operating the control dial.  |
| [Grip Ctrl Dial Dir.] | [Reverse], <b>[Normal]</b>   | Changes the direction of the adjustment when operating the control dial on the grip unit of the C300 / C300 PL or C100 camcorder, which can be attached to the GRIP terminal.   |
| [SELECT Dial Dir.]    | [Reverse], <b>[Normal]</b>   | Changes the direction of the adjustment when operating the SELECT dial.   |
| [F. Assist. B&W]      | [Both], [Magnify], [Peaking], <b>[Off]</b>                                       | Automatically switches the screen and output from the MON. terminals to B&W while the focus assist functions (peaking and magnification) are activated. You can have the screen and output from the MON. terminals switch to B&W when only the peaking is activated, when only the magnification is activated or when both are activated. |
| [Magn. Add. Disp.]    | [Peaking], [Edge Mon.], <b>[Off]</b>   | Displays peaking or the edge monitor when magnification is enabled.   |
| [3D Rec Mode]         | [On], <b>[Off]</b>   | When using another C500 or C500 PL camera to shoot 3D, this function compensates for the video and audio signals output from the 3G-SDI terminals and MON. terminals not being synchronized.  |
| [Scan Reverse Rec]    | [Both], [Vertical], [Horizontal], <b>[Off]</b>                                   | Inverts the recorded image horizontally and/or vertically. This also inverts the image output from the 3G-SDI terminals, MON. terminals, HD/SD SDI terminal and HDMI OUT terminal.  |
| [Character Rec]       | [On], <b>[Off]</b>   | When this function is set to [On], all of the onscreen displays will be recorded on the CF card exactly as they appear on the screen.   |
| [🔒 START/STOP]        | [On], <b>[Off]</b>   | Selects whether the START/STOP button will be active or locked too when the <b>POWER</b> switch is set to 🔒 (key lock) (📖 53).  |

## Customizing Onscreen Displays

For details on which onscreen displays can be customized, refer to *Onscreen Displays* (📖 55). For details on the setting options, refer to *[Custom Display 1]* and *[Custom Display 2]* (📖 174).

Operating modes:

- 1 Open the [Custom Display 1] or [Custom Display 2] submenu.  
[ LCD/VF Setup] ➤ [Custom Display 1] or [Custom Display 2]
- 2 Select the desired onscreen display.
- 3 Change the setting option and then press SET.

---

[ LCD/VF Setup]

---

[Custom Display 1]  
[Custom Display 2]

---

COPY

## Saving and Loading Camera Settings

After you adjust custom picture settings and settings in the various menus, you can save those settings on an SD card. You can load those settings at a later date or on another C500 or C500 PL camera so that you can use that camera in that same exact way.

Operating modes: CAMERA MEDIA | 4K 2K MXF

### Saving Camera Settings to an SD Card

1 Open the [Save To ] submenu.

[ Other Functions] ➤ [Transfer Menu/] ➤ [Save To ]

2 Select [Menu] or [Menu+] and then press SET.

- Selecting [Menu] will save menu settings and [Menu+] will save menu and custom picture settings.

3 Select [OK] and press SET.

- The current settings are saved to the SD card. If the SD card already has camera settings on it, they will be overwritten.

4 When the confirmation screen appears, press SET.

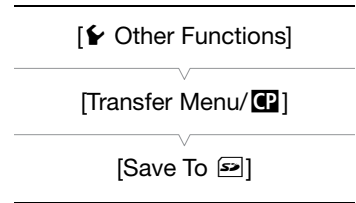

### Loading Camera Settings from an SD Card

1 Open the [Load From ] submenu.

[ Other Functions] ➤ [Transfer Menu/] ➤ [Load From ]

2 Select [Menu] or [Menu+] and then press SET.

- Selecting [Menu] will load menu settings and [Menu+] will load menu and custom picture settings.

3 Select [OK] and press SET.

- After the camera's current settings are replaced with the settings saved on the SD card, the screen will turn black momentarily and the camera will restart.

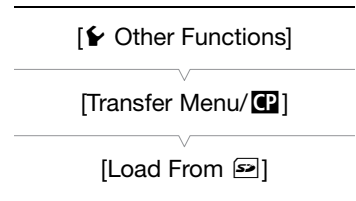

### NOTES

- The SD card includes a text file that lists the camera settings. You can check the settings by using a USB card reader to access the SD card on a computer. In the "PRIVATE\CAMSET" folder, open the file "CAMSET5.TXT".
- When loading camera settings from an SD card, even protected custom picture files in the camera will be replaced.
- For your protection, when the camera's settings are saved on an SD card, the following settings under [ Other Functions] ➤ [Wi-Fi Remote] are not saved: the encryption key/WEP index key in the wireless LAN setup of each of the configuration files [No. 1] to [No. 5] and the password in the camera settings.
- Only camera settings from other C500 / C500 PL cameras can be used with this camera.

## Playing Back MXF Clips

This section explains how to play back clips recorded on a CF card. For details on playing back clips using an external monitor, refer to *Connecting to an External Monitor* (144). For details on viewing photos on the SD card, refer to *Viewing Photos* (163). You cannot use this camera to play back video recorded in 4K or 2K mode on an external recorder. For details on developing RAW clips in order to play them back, refer to *Developing RAW Clips* (150).

Operating modes: CAMERA MEDIA

### Clip Index Screen

Playback functions are accessed from the clip index screen. To open the clip index screen, set the camera to MEDIA mode. If the CF card contains a clip with a system frequency that is different from the camera's current settings, then playback is not possible. In such case, change the [4K/2K 4K/2K/MXF Setup] ▶ [System Frequency] setting as necessary (53).

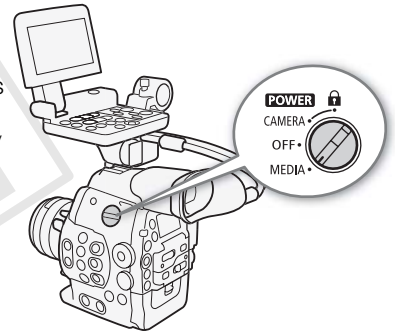

Set the **POWER** switch to MEDIA.

- The camera switches to MEDIA mode and the clip index screen appears.

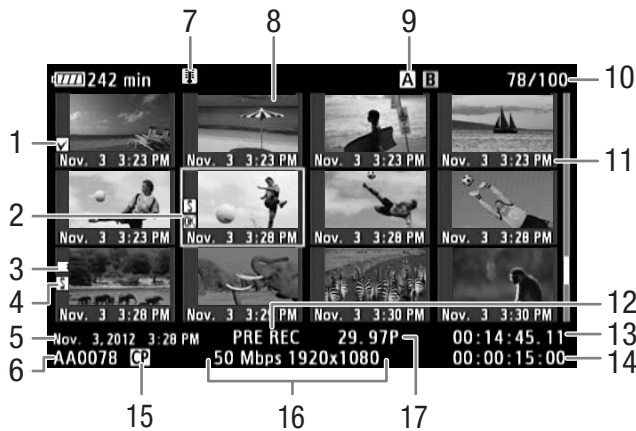

- |   |   |    |  |
|---|---|----|--|
| 1 | mark/ mark (📖 103, 132)   | 9  | Currently selected CF card slot (📖 46)       |
| 2 | Orange selection frame  | 10 | Clip number / Total number of clips          |
| 3 | Relay recording: Appears when a clip begins on one CF card and continues on the other. (📖 46) | 11 | Recording date (month and day only) and time |
| 4 | Shot mark (📖 102, 136)  | 12 | Special recording mode (📖 105)               |
| 5 | Recording date and time   | 13 | Time code of thumbnail                       |
| 6 | Clip name (📖 53)  | 14 | Total recording time                         |
| 7 | Temperature warning icon (📖 188)  | 15 | Embedded custom picture file (📖 114)         |
| 8 | Clip thumbnail (📖 137)  | 16 | Bit rate and resolution (📖 60)               |
|   |   | 17 | Frame rate*                                  |

\* For clips recorded using slow & fast motion mode, the shooting frame rate and playback frame rate will both be displayed.

### Switching Between the CF Card Slots

If both CF card slots contain a CF card, you can switch between them as necessary.

Operating modes: CAMERA MEDIA

Press the SLOT SELECT button.

- The access indicator of the selected CF card slot will illuminate in green.

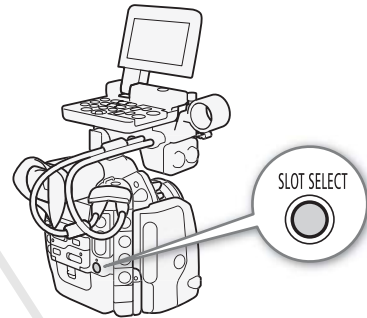

### Switching to Other Index Screens

All of the clips on a CF card can be accessed from the clip index screen. However, you can switch to other index screens that show only clips with an mark ([ Mark] index screen), clips with a mark ([ Mark] index screen), or photos\* ([Photos] index screen).

\* Photos are saved on the SD card.

- 1 Press the INDEX button.
  - The index screen selection menu appears.
- 2 Select the desired index screen and then press SET.
  - The selected index screen appears.
  - Select [Cancel] instead to cancel the operation.
  - Press the INDEX button again to return to the clip index screen.

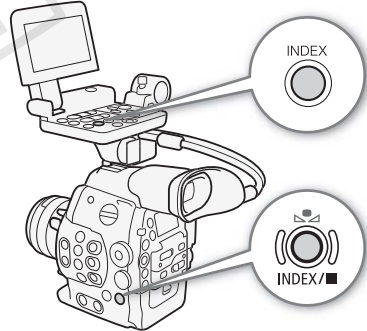

### Playing Back Clips

You can play back clips from the clip index screen, [ Mark] index screen and [ Mark] index screen. Use the playback control buttons on the monitor unit. When the monitor unit is not attached, you have limited playback control options (play/pause/stop only) with the buttons on the camera and full playback control options using the joystick and joystick guide.

- 1 Move the orange selection frame to the clip you want to play back.
- 2 Press the button to start playback.
  - Playback will start from the clip selected and continue until the end of the last clip in the index screen. When the last frame of the last clip is reached, playback will be paused.

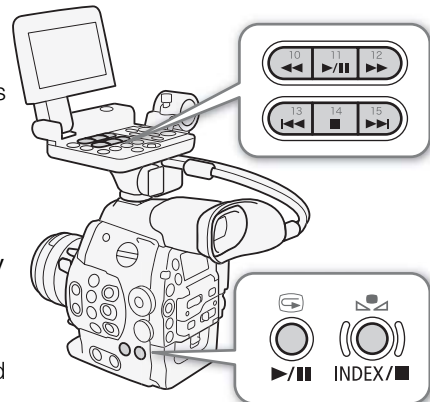

- Press the ►/|| button again or press SET to pause/resume the playback.
- Press the ■ button to stop the playback and return to the index screen.

**!** IMPORTANT

- Observe the following precautions while the CF **A** or CF **B** access indicator is illuminated in red. Failure to do so may result in permanent data loss.
  - Do not disconnect the power source or turn off the camera.
  - Do not open the cover of the CF card slot being accessed.

**i** NOTES

- You may notice brief stops in video or audio playback between clips.

### Onscreen Displays

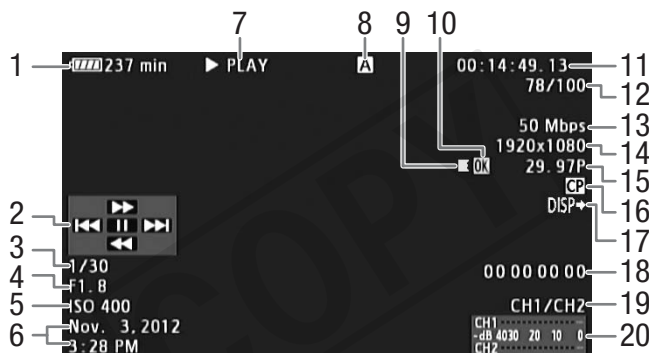

- |   |  |
|---|--|
| 1 Remaining battery time ( 56)                  | 11 Time code ( 84)                     |
| 2 Joystick guide ( 128)                         | 12 Clip number / Total number of clips |
| 3 Shutter speed <sup>1</sup> ( 67)              | 13 Bit rate ( 64)/Recording mode ( 60) |
| 4 <b>C500</b> Aperture value <sup>1</sup> ( 74) | 14 Resolution ( 62, 64)                |
| 5 ISO speed/Gain <sup>1</sup> ( 70)             | 15 Frame rate ( 60) <sup>3</sup>       |
| 6 Recording date and time <sup>2</sup>          | 16 Embedded custom picture file ( 114) |
| 7 Playback operation                            | 17 Output displays ( 149)              |
| 8 Selected CF card                              | 18 User bit ( 87)                      |
| 9 Relay recording                               | 19 Audio output channel ( 96)          |
| 10 <b>OK</b> mark/ <b>✓</b> mark ( 103, 132)    | 20 Audio level meter                   |

<sup>1</sup> Appears when [LCD/VF Setup] [Metadata Display] [Camera Data] is set to [On].

<sup>2</sup> Appears when [LCD/VF Setup] [Metadata Display] [Date/Time] is set to [On].

<sup>3</sup> When playing back clips that were recorded using slow & fast motion mode, the shooting frame rate and playback frame rate will both be displayed.

### 7 Playback operation

- ▶ PLAY Playback
- ⏸ PAUSE Playback pause
- ◀◀/▶▶ Frame reverse/Frame advance
- F FWD ▶▶ Fast playback\*
- ◀◀ F REV Fast reverse playback\*

\* The playback speed (x5, x15 or x60) will also appear in the indicator.

### 9 Relay recording

Appears when a clip begins on one CF card and continues uninterrupted on the other. ■ indicates the first part of the recording, ■ indicates the middle part(s) and ■ indicates the last part.

## Playback Controls

When you play back a clip, operate the buttons on camera's body or on the monitor unit or use the joystick and joystick guide to use fast playback, play back frame-by-frame or skip clips. Refer to the following table.

### Available Playback Types

| Playback type                             | Operation  |
|---|--|
| Fast playback                             | Buttons: Press the ◀◀ or ▶▶ button.<br>Joystick: During playback, push the joystick up or down.<br>Repeat to increase the playback speed to approximately 5x → 15x → 60x the normal speed. |
| Frame advance/reverse                     | Joystick: During playback pause, push the joystick up or down.   |
| Skip to the beginning of the next clip    | Buttons: Press the ▶▶  button.<br>Joystick: Push the joystick right.   |
| Skip to the beginning of the current clip | Buttons: Press the  ◀◀ button.<br>Joystick: Push the joystick left.  |
| Skip to the previous clip                 | Buttons: Press the  ◀◀ button twice.<br>Joystick: Push the joystick left twice.  |
| Return to playback mode                   | Buttons: Press the ▶/⏸ button.<br>Joystick: Press the joystick itself (SET button).  |

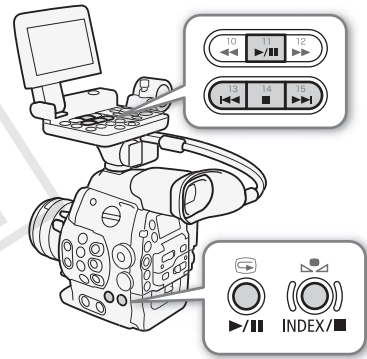



### NOTES

- There is no audio during any of the playback types listed in the previous table.
- During some special playback modes, you may notice some anomalies (blocky video artifacts, banding, etc.) in the playback picture.
- The speed indicated on the screen is approximate.
- During frame advance, the time advanced between frames depends on the video configuration used: 0.2 seconds (for 1280x720/24.00P, 1280x720/23.98P or 1280x720/59.94P), 0.25 seconds (for 1280x720/50.00P) and 0.5 seconds for other video configurations.
- You can press the DISP. button to turn the joystick guide display on and off.



## Audio Output

During playback, audio will be available through the  (headphone) terminal. You can adjust the headphone volume with the [] Audio Setup] ➤ [Audio Output] ➤ [Headphone Volume] setting. The audio signal will also be output through the HD/SD SDI terminal and the HDMI OUT terminal.

### NOTES

- For details on changing the audio channel, refer to *Selecting the Audio Channel* ( 96).

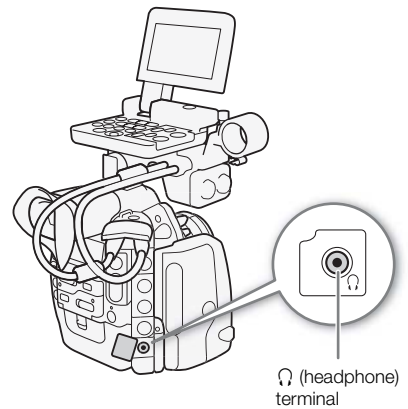

COPY

## MXF Clip Operations

Besides playing back a clip, you can perform other operations such as deleting a clip or displaying clip information. This is done through the clip menu, which contains different functions depending on the index screen. You can use the functions in the [Other Functions] menu to perform some of the operations on all the clips. Refer to the following table for available functions and refer to the following pages for more details of the functions.

Operating modes: CAMERA MEDIA

### Clip Menu Functions

| Menu item                                | Description  | Index screen |                        |   | 📖   |
|--|--|--------------|------------------------|---|-----|
|  |  | Clip         | [OK Mark]/<br>[✓ Mark] | [Shot Mark] <sup>1</sup> /<br>[Expand Clip] |     |
| [Display Clip Info]                      | Displays various information about a clip.                                       | ●            | ●                      | –   | 131 |
| [Add  Mark]/<br>[Delete  Mark]           | Adds or deletes an  mark.  | ●            | ● <sup>2</sup>         | –   | 132 |
| [Add  Mark]/<br>[Delete  Mark]           | Adds or deletes a  mark.   | ●            | ● <sup>3</sup>         | –   | 132 |
| [Copy Clip]                              | Copies a clip from one CF card to the other.                                     | ●            | ● <sup>2</sup>         | –   | 133 |
| [Delete Clip]                            | Deletes a clip.  | ●            | ● <sup>3</sup>         | –   | 134 |
| [Shot Mark]                              | Displays an index screen of all the frames of a clip that have either shot mark. | ●            | ●                      | –   | 135 |
| [Shot Mark 1]                            | Displays an index screen of all the frames of a clip that have the  mark.        | ●            | ●                      | –   | 135 |
| [Shot Mark 2]                            | Displays an index screen of all the frames of a clip that have the  mark.        | ●            | ●                      | –   | 135 |
| [Expand Clip]                            | Displays an index screen that shows frames of a clip at a fixed interval.        | ●            | ●                      | –   | 136 |
| [Delete User Memo]                       | Deletes the user memo and GPS information of a clip.                             | ●            | ●                      | –   | 134 |
| [Copy  File]                             | Copies the custom picture file from a clip to the camera.                        | ●            | ●                      | –   | 134 |
| [Add Shot Mark 1]/<br>[Del. Shot Mark 1] | Adds or deletes a  mark.   | –            | –                      | ●   | 136 |
| [Add Shot Mark 2]/<br>[Del. Shot Mark 2] | Adds or deletes a  mark.   | –            | –                      | ●   | 136 |
| [Fewer Index Pics]                       | Decreases the number of thumbnails that are displayed.                           | –            | –                      | ● <sup>4</sup>                              | 136 |
| [More Index Pics]                        | Increases the number of thumbnails that are displayed.                           | –            | –                      | ● <sup>4</sup>                              | 136 |
| [Pause]                                  | Switches to playback of a clip with playback paused on the selected frame.       | –            | –                      | ●   | –   |
| [Set Index Picture]                      | Sets the thumbnail used in the clip index screen.                                | –            | –                      | ●   | 137 |

<sup>1</sup> Includes also the [Shot Mark 1] and [Shot Mark 2] index screens.

<sup>2</sup> [OK Mark] index screen only.

<sup>3</sup> [✓ Mark] index screen only.

<sup>4</sup> [Expand Clip] index screen only.

### Using the Clip Menu

1 Select a clip and then press SET.

- The clip menu appears. Available functions depend on the index screen and which functions are enabled.

2 Select the desired function and then press SET.

- The function is enabled. For some functions, further action may be required. Follow the onscreen directions.
- Press the CANCEL button instead to return to the clip index screen.

### ! IMPORTANT

- Observe the following precautions while the CF **A** or CF **B** access indicator is illuminated in red. Failure to do so may result in permanent data loss.
  - Do not disconnect the power source or turn off the camera.
  - Do not open the cover of the either CF card slot.

## Displaying Clip Information

Select [Display Clip Info] in the clip menu to display the selected clip's information screen ([Clip Info] screen). Push the joystick left/right to switch to the previous/next clip. When you are finished, press the CANCEL button to return to the clip index screen.



- |   |                                       |    |                                      |
|---|---------------------------------------|----|--------------------------------------|
| 1 | Thumbnail of the selected clip        | 10 | Clip name ( 53)                      |
| 2 | Thumbnail of the previous clip        | 11 | Bit rate and resolution ( 60)        |
| 3 | Thumbnail of the next clip            | 12 | Frame rate ( 60)*                    |
| 4 | Shot mark ( 102, 136)                 | 13 | OK mark / mark ( 103, 132)           |
| 5 | GPS information                       | 14 | Embedded custom picture file ( 103)  |
| 6 | Special recording mode ( 105)         | 15 | Time code of the clip thumbnail      |
| 7 | Currently selected CF card slot ( 46) | 16 | Time code of the first frame in clip |
| 8 | Clip number / Total number of clips   | 17 | Time code of the last frame in clip  |
| 9 | Recording date and time               | 18 | Clip duration                        |

\* When displaying clips that were recorded using slow & fast motion mode, the shooting frame rate and playback frame rate will both be displayed.

## Displaying the Lens Information (C500) and User Memo

From the [Clip Info] screen, push the joystick up or turn the SELECT dial up to display the [Lens & MEMO] screen. In this screen you can check details about the lens used to record the clip. If the clip has an embedded user memo, you will see the user memo content in this screen as well. Push the joystick down or turn the SELECT dial down to return to the [Clip Info] screen.

## Displaying Custom Picture Settings

When displaying the [Clip Info] screen of a clip that has a custom picture file recorded with it, push the joystick down or turn the SELECT dial down to display the first of three screens with the clip's custom picture settings ([CP Data 1/3] screen). Push the joystick down or turn the SELECT dial down to switch the [CP Data 2/3] screen → [CP Data 3/3] screen → [Lens & MEMO] screen → [Clip Info] screen.

## Adding OK Marks or Check Marks

If you add an OK mark (OK) or check mark (✓) to a clip, you can later display an index screen that shows only the clips with an OK mark or only the clips with a check mark. Furthermore, you cannot delete clips with an OK mark so you can use it to protect important clips.

### Adding an OK Mark or Check Mark during Playback

To add an OK mark (OK) or check mark (✓) to a clip during playback or playback pause, you must first set an assignable button to [Add OK Mark] or [Add Check Mark] in advance.

- 1 Set an assignable button to [Add OK Mark] or [Add Check Mark] (□ 111).
  - To add both types of clip marks (to different clips), set one assignable button to [Add OK Mark] and another assignable button to [Add Check Mark].
- 2 During playback or playback pause, press the assignable button to add the clip mark.
  - A message indicating the clip mark will appear and the selected clip mark will be added to the clip.
  - Adding a clip mark to a clip during playback will pause the playback.

### Adding an OK Mark or Check Mark from the Index Screen

- 1 Select the desired clip and then press SET to open the clip menu.
- 2 Select [Add OK Mark] or [Add Check Mark] and then press SET.
  - The clip information screen appears and it prompts you to confirm the operation.
- 3 Select [OK] and then press SET.
  - The screen changes back to the clip index screen and an OK mark or check mark appears next to the selected clip's thumbnail.
  - Select [Cancel] instead to cancel the operation.

### NOTES

- A clip cannot have both an OK mark and check mark at the same time. When you add a check mark to a clip with an OK mark, the OK mark will be deleted. Similarly, when you add an OK mark to a clip with a check mark, the check mark will be deleted.

## Deleting OK Marks or Check Marks

### Deleting an OK Mark or Check Mark from a Clip

- 1 Select the desired clip and then press SET to open the clip menu.
- 2 Select [Delete OK Mark] or [Delete Check Mark] and then press SET.
  - The clip information screen appears and it prompts you to confirm the operation.
- 3 Select [OK] and then press SET.
  - The screen changes back to the clip index screen the selected mark is deleted.
  - Select [Cancel] instead to cancel the operation.

### Deleting **OK** Marks from All Clips

- 1 Open the [Delete All **OK** Marks] submenu.  
[**Other Functions**] ➤ [Delete All **OK** Marks]
- 2 Select [OK] and then press SET.
  - All **OK** marks from clips on the selected CF card will be deleted.
  - Select [Cancel] instead to cancel the operation.
  - While the **OK** marks are being deleted, you can press SET to cancel.
- 3 When the confirmation message appears, press SET.

---

[**Other Functions**]

---

[Delete All **OK** Marks]

---

133

### Copying Clips

You can copy clips from one CF card to the other. The copied clips will retain their original name.

#### Copying a Single Clip

- 1 Select the desired clip and then press SET to open the clip menu.
- 2 Select [Copy Clip] and then press SET.
  - The clip information screen appears and it prompts you to confirm the operation. You can also check the available space on both CF cards.
- 3 Select [OK] and then press SET.
  - Select [Cancel] instead to cancel the operation.
  - While the clip is being copied, you can press SET to cancel.
- 4 When the confirmation message appears, press SET.
  - The selected clip is copied to the other CF card and the screen changes back to the clip index screen.

#### Copying All Clips

- 1 Open the [Copy All Clips] submenu.  
[**Other Functions**] ➤ [Clips] ➤ [Copy All Clips]
- 2 Select [OK] and then press SET.
  - All of the clips on the selected CF card will be copied to the other CF card.
  - Select [Cancel] instead to cancel the operation.
  - While the clips are being copied, you can press SET to cancel.
- 3 When the confirmation message appears, press SET.

---

[**Other Functions**]

---

[Clips]

---

[Copy All Clips]

---

#### Copying All Clips with an **OK** Mark

- 1 Open the [Copy **OK** Clips] submenu.  
[**Other Functions**] ➤ [Clips] ➤ [Copy **OK** Clips]
- 2 Select [OK] and then press SET.
  - All of the clips with an **OK** mark on the selected CF card will be copied to the other CF card.
  - Select [Cancel] instead to cancel the operation.
  - While the clips are being copied, you can press SET to cancel.
- 3 When the confirmation message appears, press SET.

---

[**Other Functions**]

---

[Clips]

---

[Copy **OK** Clips]

---

**i** NOTES

- You cannot copy a clip if either CF card slot cover is open.
- If a clip is being copied to a card that already has a clip with the same number (the last 4 digits in the clip name), then the copied clip will be renamed with the following number.

**Deleting Clips**

You can delete any clip except those with an **OK** mark. To delete such clips, delete the **OK** mark beforehand.

**Deleting a Single Clip**

- 1 Select the desired clip and then press SET to open the clip menu.
- 2 Select [Delete Clip] and then press SET.
  - The clip information screen appears and it prompts you to confirm the operation.
- 3 Select [OK] and then press SET.
  - Select [Cancel] instead to cancel the operation.
  - While the clip is being deleted, the operation cannot be canceled.
- 4 When the confirmation message appears, press SET.

**Deleting All Clips**

- 1 Open the [Delete All Clips] submenu.
 

[Other Functions] ➤ [Clips] ➤ [Delete All Clips]
- 2 Select [OK] and then press SET.
  - All of the clips (except for clips with an **OK** mark) on the selected CF card will be deleted.
  - Select [Cancel] instead to cancel the operation.
  - While the clips are being deleted, you can press SET to cancel.
- 3 When the confirmation message appears, press SET.

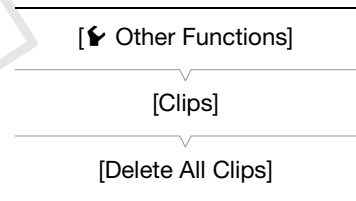
**Deleting the User Memo**

- 1 Select the desired clip and then press SET to open the clip menu.
- 2 Select [Delete User Memo] and then press SET.
  - The [Delete User Memo] screen appears and it prompts you to confirm the operation.
- 3 Select [OK] and then press SET.
  - The user memo and GPS information is deleted and the screen changes back to the clip index screen.
  - Select [Cancel] instead to cancel the operation.

**Copying a Custom Picture File Embedded in a Clip**

You can copy the custom picture file embedded in a clip to the camera.

- 1 Select the desired clip (a clip with the **CP** icon) and then press SET to open the clip menu.
- 2 Select [Copy **CP** File] and then press SET.

- The [CP Data 1/3] screen appears with the orange selection frame indicating a custom picture file slot in the camera.
- Alternatively, you can press the CUSTOM PICTURE button.
- You can push the joystick up/down or turn the SELECT dial to display the [CP Data 2/3] and [CP Data 3/3] screens.

3 Push the joystick left/right to select the desired file slot and then press SET.

4 Select [OK] and then press SET.

- The custom picture file already in the selected file slot will be overwritten.
- Select [Cancel] instead to cancel the operation.

5 When the confirmation message appears, press SET.

### **i** NOTES

- You cannot copy the custom picture file to a file slot with a protected file.
- By default, file slots [C8] and [C9] are protected.

## Displaying an Index Screen of Shot Marks

After you add shot marks to a clip, you can display an index screen that contains all the frames in a clip with either shot mark, only the **S1** mark or only the **S2** mark. When you play back a clip from this index screen, playback will start from the frame indicated by the shot mark. You can also perform other operations from this index screen, such as adding and deleting shot marks.

1 Select the desired clip and then press SET to open the clip menu.

2 Select [Shot Mark] and then press SET.

- The [Shot Mark] index screen appears, which contains all the frames with shot marks in the clip. Select instead [Shot Mark 1] to display an index screen only of the frames with the **S1** mark or [Shot Mark 2] to display an index screen only of the frames with the **S2** mark.
- The time code under the thumbnail indicates the time code of the frame with the shot mark.
- Press the INDEX button or CANCEL button to return to the clip index screen.



### **i** NOTES

- After you finish playing back a clip from this index screen, the index screen that was open before the [Shot Mark] index screen will appear.

## Displaying a Frame Index Screen of a Single Clip

You can display an index screen of a single clip broken down as frames at fixed intervals. This is useful when you have a long clip or wish to play back a clip from a certain point. You can change how many thumbnails are displayed. You can also perform other operations from this index screen, such as adding and deleting shot marks.

1 Select the desired clip and then press SET to open the clip menu.

2 Select [Expand Clip] and then press SET.

- The [Expand Clip] index screen appears, which shows thumbnails of frames taken from the clip at fixed intervals. The time code under the thumbnail indicates the time code of the frame.
- You can change the fixed interval between frames by showing more or fewer thumbnails. To show more thumbnails, open the clip menu and select [More Index Pics] and then press SET. To show fewer thumbnails, select [Fewer Index Pics] and then press SET.
- Press the INDEX button or CANCEL button to return to the clip index screen.



### **i** NOTES

- After you finish playing back a clip from this index screen, the index screen that was open before the [Expand Clip] index screen will appear.

## Adding Shot Marks

You can add shot marks (S1, S2 or both) to shots in a clip you want to set apart. Later, you can display an index screen that shows only the clips with a S1 mark, only the clips with a S2 mark, or only clips with either shot mark.

### Adding Shot Marks during Playback

To add an S1 mark or S2 mark to a clip during playback or playback pause, you must first set an assignable button to [Add Shot Mark 1] or [Add Shot Mark 2] in advance.

1 Set an assignable button to [Add Shot Mark 1] or [Add Shot Mark 2] (111).

2 During playback or playback pause, press the assignable button at the point in the clip to add the shot mark.

- A message indicating the shot mark appears on the screen and the shot mark is added to the clip.
- Adding a shot mark to a clip during playback will pause the playback.

### Adding Shot Marks from the Index Screen

1 Open the [Shot Mark] index screen or [Expand Clip] index screen.

2 Select the desired frame (thumbnail) and then press SET to open the clip menu.



- 3 Select [Add Shot Mark 1] or [Add Shot Mark 2] and then press SET.
  - The clip information screen appears and it prompts you to confirm the operation.
- 4 Select [OK] and then press SET.
  - The screen changes back to the previous index screen and the selected shot mark appears next to the selected clip's thumbnail.
  - Select [Cancel] instead to cancel the operation.

### NOTES

- Up to 100 shot marks (S1 and S2 marks combined) can be added to a single clip.
- There may be up to a 0.5 second delay from when you press the button to when the camera adds the shot mark.

## Deleting Shot Marks

- 1 Open the [Shot Mark] index screen or [Expand Clip] index screen.
- 2 Select the desired frame (thumbnail) and then press SET to open the clip menu.
- 3 Select [Del. Shot Mark 1] or [Del. Shot Mark 2] and then press SET.
  - The clip information screen appears and it prompts you to confirm the operation.
- 4 Select [OK] and then press SET.
  - The selected mark is deleted and the screen changes back to the previous index screen.
  - If a frame has no shot marks, it will no longer appear in the [Shot Mark] index screen.
  - Select [Cancel] instead to cancel the operation.

## Changing a Clip's Thumbnail

You can change the thumbnail that appears in the clip index screen to a thumbnail of a frame that appears in the [Shot Mark] index screen or [Expand Clip] index screen.

- 1 Open the [Shot Mark] index screen or [Expand Clip] index screen.
- 2 Select the desired frame (thumbnail) and then press SET to open the clip menu.
- 3 Select [Set Index Picture] and then press SET.
  - The clip information screen appears and it prompts you to confirm the operation.
- 4 Select [OK] and then press SET.
  - The selected frame is set as the thumbnail and the screen changes back to the previous index screen.
    - appears next to the thumbnail of the selected frame.
  - Select [Cancel] instead to cancel the operation.

### NOTES

- When playing back a clip from the clip index screen, playback will start from the beginning of the clip, regardless of the thumbnail.

COPY

## Video Output Configuration

The video signal output from the MON. terminals, HD/SD SDI terminal, HDMI OUT terminal and SYNC OUT terminal depends on the clip's video configuration, the capability of the external monitor (for video output from the HDMI OUT terminal) and on various menu settings. The HD/SD SDI terminal, HDMI OUT terminal and SYNC OUT terminal are able to output the onscreen displays and superimpose them on the picture of an external monitor (📄 149).

### Video Configuration and Video Output Configuration for 4K and 2K Modes

Refer to the following tables for the video configuration for recording, video configuration recorded on the CF card and video output configuration from each terminal during 4K and 2K modes.

Operating modes:  CAMERA  MEDIA |  4K  2K  MXF

| Video configuration for recording |  |                                     |            | MON. terminals <sup>1, 2, 3</sup>                      | HD/SD SDI terminal <sup>4, 5, 6</sup> |            |
|-----------------------------------|--|-------------------------------------|------------|--|---------------------------------------|------------|
| System priority                   | Recording mode   | Resolution                          | Frame rate |  | HD <sup>3</sup>                       | SD         |
| 4K                                | RAW  | 4096×2160<br>3840×2160              | 59.94P     | 1080/29.97PsF <sup>7</sup><br>1080/59.94i <sup>7</sup> | 1080/29.97 (P/PsF)                    | 480/59.94i |
|                                   |  |                                     | 29.97P     | 1080/29.97 (P/PsF)                                     |                                       |            |
|                                   |  |                                     | 23.98P     | 1080/23.98 (P/PsF)                                     |                                       |            |
|                                   |  |                                     | 50.00P     | 1080/25.00PsF <sup>7</sup><br>1080/50.00i <sup>7</sup> | 1080/25.00 (P/PsF)                    | 576/50.00i |
|                                   |  |                                     | 25.00P     | 1080/25.00 (P/PsF)                                     |                                       |            |
|                                   |  |                                     | 24.00P     | 1080/24.00 (P/PsF)                                     | 1080/24.00 (P/PsF)                    | –          |
|                                   | HRAW<br>4K1K RAW   | 4096×1080<br>3840×1080 <sup>8</sup> | 59.94P     | 1080/29.97PsF <sup>7</sup><br>1080/59.94i <sup>7</sup> | 720/59.94P                            | 480/59.94i |
|                                   |  |                                     | 50.00P     | 1080/25.00PsF <sup>7</sup><br>1080/50.00i <sup>7</sup> | 720/50.00P                            | 576/50.00i |
| 2K                                | <input type="checkbox"/> RGB444<br>12-bit<br><br><input type="checkbox"/> RGB444<br>10-bit | 2048×1080<br>1920×1080              | 59.94P     | 1080/29.97PsF <sup>7</sup><br>1080/59.94i <sup>7</sup> | 1080/29.97 (P/PsF)                    | 480/59.94i |
|                                   |  |                                     | 29.97P     | 1080/29.97 (P/PsF)                                     |                                       |            |
|                                   |  |                                     | 23.98P     | 1080/23.98 (P/PsF)                                     |                                       |            |
|                                   |  |                                     | 50.00P     | 1080/25.00PsF <sup>7</sup><br>1080/50.00i <sup>7</sup> | 1080/25.00 (P/PsF)                    | 576/50.00i |
|                                   |  |                                     | 25.00P     | 1080/25.00 (P/PsF)                                     |                                       |            |
|                                   |  |                                     | 24.00P     | 1080/24.00 (P/PsF)                                     | 1080/24.00 (P/PsF)                    | –          |
|                                   | <input type="checkbox"/> YCC422<br>10-bit  | 2048×1080<br>1920×1080              | 59.94P     | 1080/29.97PsF <sup>7</sup><br>1080/59.94i <sup>7</sup> | 720/59.94P                            | 480/59.94i |
|                                   |  |                                     | 50.00P     | 1080/25.00PsF <sup>7</sup><br>1080/50.00i <sup>7</sup> | 720/50.00P                            | 576/50.00i |

| Video configuration for recording |                  |                        |            | HDMI OUT terminal <sup>5, 9</sup> |            | SYNC OUT terminal <sup>10</sup> |            |
|-----------------------------------|------------------|------------------------|------------|-----------------------------------|------------|---------------------------------|------------|
| System priority                   | Recording mode   | Resolution             | Frame rate | HD                                | SD         | HD                              | SD         |
| 4K                                | RAW              | 4096×2160<br>3840×2160 | 59.94P     | 1080/59.94i                       | 480/59.94P | 1080/59.94i                     | 480/59.94i |
|                                   |                  |                        | 29.97P     |                                   |            |                                 |            |
|                                   |                  |                        | 23.98P     |                                   |            |                                 |            |
|                                   |                  |                        | 50.00P     | 1080/50.00i                       | 576/50.00P | 1080/50.00i                     | 576/50.00i |
|                                   |                  |                        | 25.00P     |                                   |            |                                 |            |
|                                   |                  |                        | 24.00P     | 1080/60.00i                       | –          | 1080/60.00i                     | –          |
|                                   | HRAW             | 4096×1080<br>3840×1080 | 59.94P     | 720/59.94P                        | 480/59.94P | 720/59.94P                      | 480/59.94i |
|                                   |                  |                        | 50.00P     | 720/50.00P                        | 576/50.00P | 720/50.00P                      | 576/50.00i |
| 2K                                | RGB444<br>12-bit | 2048×1080<br>1920×1080 | 59.94P     | 1080/59.94i                       | 480/59.94P | 1080/59.94i                     | 480/59.94i |
|                                   |                  |                        | 29.97P     |                                   |            |                                 |            |
|                                   |                  |                        | 23.98P     |                                   |            |                                 |            |
|                                   |                  |                        | 50.00P     | 1080/50.00i                       | 576/50.00P | 1080/50.00i                     | 576/50.00i |
|                                   |                  |                        | 25.00P     |                                   |            |                                 |            |
|                                   |                  |                        | 24.00P     | 1080/60.00i                       | –          | 1080/60.00i                     | –          |
|                                   | YCC422<br>10-bit | 2048×1080<br>1920×1080 | 59.94P     | 720/59.94P                        | 480/59.94P | 720/59.94P                      | 480/59.94i |
|                                   |                  |                        | 50.00P     | 720/50.00P                        | 576/50.00P | 720/50.00P                      | 576/50.00i |

- <sup>1</sup> The resolution will be set to 1920x1080. When [4K/2K] 4K/2K/MXF Setup] ➤ [4K (4096/3840)] or [2K (2048/1920)] ➤ [Resolution] is set to [4096x2160], [4096x1080] or [2048x1080], you can select 2048x1080 or 1920x1080 for the output (☐ 145).
- <sup>2</sup> The camera can apply onscreen markers, zebra patterns, peaking and magnification to the MON. 1 terminal output. The camera can apply magnification to the MON. 2 terminal output.
- <sup>3</sup> Depending on the signal, you can switch between the P and PsF setting (☐ 145, 147) for output.
- <sup>4</sup> Set [☐ Video Setup] (in [MEDIA] mode) or [4K/2K] 4K/2K/MXF Setup] (in [CAMERA] mode) ➤ [HD/SD SDI] ➤ [Output] to [HD], [SD] or [Off].
- <sup>5</sup> You can display zebra patterns on an external monitor during HD output (☐ 83). Zebra patterns will not be output during SD output.
- <sup>6</sup> When the camera is connected via HDMI OUT terminal to an external monitor, the video signal output from the HD/SD SDI terminal will be the same as that from the HDMI OUT terminal.
- <sup>7</sup> When the resolution is 2048x1080, the scan mode is PsF. When the resolution is 1920x1080, the scan mode is interlaced.
- <sup>8</sup> HRAW only.
- <sup>9</sup> Video output will automatically switch to HD or SD, depending on the capability of the external monitor.
- <sup>10</sup> Set [☐ Video Setup] (in [MEDIA] mode) or [4K/2K] 4K/2K/MXF Setup] (in [CAMERA] mode) ➤ [SYNC OUT] ➤ [Output] to [HD-Y] (HD component video, luminance signal) or [Composite] (SD analog composite signal).

## Video Output Configuration for MXF Mode

Refer to the following table for the video output configuration from each terminal during recording and playback.

Operating modes: CAMERA MEDIA | 4K 2K MXF

| Video configuration    |            | HD/SD SDI terminal <sup>2, 3, 4</sup> |                            |            | HDMI OUT terminal <sup>3, 5</sup> |            | SYNC OUT terminal <sup>6</sup> |            |
|------------------------|------------|---------------------------------------|----------------------------|------------|-----------------------------------|------------|--------------------------------|------------|
| Resolution             | Frame rate | HD <sup>1</sup>                       | HD                         | SD         | HD                                | SD         | HD                             | SD         |
|                        |            | ( <span>CAMERA</span> mode)           | ( <span>MEDIA</span> mode) |            |                                   |            |                                |            |
| 1920×1080<br>1440×1080 | 59.94i     | 1080/59.94i                           | 1080/59.94i                | 480/59.94i | 1080/59.94i                       | 480/59.94P | 1080/59.94i                    | 480/59.94i |
|                        | 29.97P     | 1080/29.97 (P/PsF)                    |                            |            |                                   |            |                                |            |
|                        | 23.98P     | 1080/23.98 (P/PsF)                    |                            |            |                                   |            |                                |            |
|                        | 50.00i     | 1080/50.00i                           | 1080/50.00i                | 576/50.00i | 1080/50.00i                       | 576/50.00P | 1080/50.00i                    | 576/50.00i |
|                        | 25.00P     | 1080/25.00 (P/PsF)                    |                            |            |                                   |            |                                |            |
|                        | 24.00P     | 1080/24.00 (P/PsF)                    |                            |            |                                   |            |                                |            |
| 1280×720               | 59.94P     | 720/59.94P                            | 720/59.94P                 | 480/59.94i | 720/59.94P                        | 480/59.94P | 720/59.94P                     | 480/59.94i |
|                        | 29.97P     | 720/29.97P                            |                            |            |                                   |            |                                |            |
|                        | 23.98P     | 720/23.98P                            |                            |            |                                   |            |                                |            |
|                        | 50.00P     | 720/50.00P                            | 720/50.00P                 | 576/50.00i | 720/50.00P                        | 576/50.00P | 720/50.00P                     | 576/50.00i |
|                        | 25.00P     | 720/25.00P                            |                            |            |                                   |            |                                |            |
|                        | 24.00P     | 720/24.00P                            |                            |            |                                   |            |                                |            |

<sup>1</sup> Depending on the signal, you can switch between the P and PsF setting ( 145) for output.

<sup>2</sup> Set [Video Setup] (in MEDIA mode) or [4K/2K/MXF Setup] (in CAMERA mode) ➤ [HD/SD SDI] ➤ [Output] to [HD], [SD] or [Off].

<sup>3</sup> You can display zebra patterns on an external monitor during HD output ( 83). Zebra patterns will not be output during SD output.

<sup>4</sup> When the camera is connected via HDMI OUT terminal to an external monitor, the video signal output from the HD/SD SDI terminal will be the same as that from the HDMI OUT terminal.

<sup>5</sup> Video output will automatically switch to HD or SD, depending on the capability of the external monitor.

<sup>6</sup> Set [Video Setup] (in MEDIA mode) or [4K/2K/MXF Setup] (in CAMERA mode) ➤ [SYNC OUT] ➤ [Output] to [HD-Y] (HD component video, luminance signal) or [Composite] (SD analog composite signal).

## Selecting the Color Space

You can select the color space of the video that is output from the 3G-SDI terminal or MON. terminals. If you select a color space with a wider range of colors than that of BT. 709, you can improve the color reproduction in the video. When checking the output, you will need a display device that is compatible with each color space.

Operating modes: CAMERA MEDIA | 4K 2K MXF

### 1 Open the [Color Space] submenu.

[Camera Setup] ➔ [Color Space]

### 2 Select the desired option and then press SET.

- The color space of the video output from the 3G-SDI terminal and MON. terminals will change accordingly.

#### Options

- [BT. 709]: Standard color space that is compatible with sRGB specifications.
- [DCI-P3+]: Color space that retains the hues of DCI-P3, which is a color space whose guidelines were established by the DCI (Digital Cinema Initiatives), and possesses a wider color gamut than that of DCI-P3 and BT. 709 (sRGB). DCI-P3+ has good color reproduction of subjects with high-color intensity. Because this color space extends the gamut of high-intensity colors without changing hues, you can use it for the DCI workflow just by adjusting the intensity.
- [C. Gamut]: Cinema Gamut. Color space developed by Canon and based on the specific characteristics of the camera's sensor. Features a wider color gamut than that of DCI-P3+. Use this setting with workflows that require ACES color space.

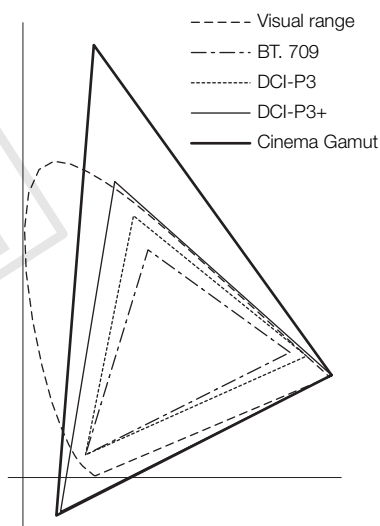
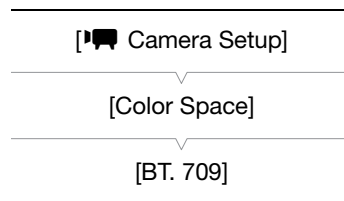

**Available color space and gamma curve settings**

The color space and gamma curve of the video output by the 3G-SDI terminal and MON. terminals depend on the combination of settings.

| Terminal        | [Color Space] setting                | LUT setting <sup>1</sup> | [ACESPX10] setting <sup>2</sup> | Terminal output |             |
|-----------------|--------------------------------------|--------------------------|---------------------------------|-----------------|-------------|
|                 |                                      |                          |                                 | Color space     | Gamma       |
| 3G-SDI          | [BT. 709]                            | -                        | -                               | BT. 709         | Canon Log   |
|                 | [DCI-P3+]                            |                          |                                 | DCI-P3+         | Canon Log   |
|                 | [C. Gamut]                           |                          |                                 | Cinema Gamut    | Canon Log   |
| MON. 1 / MON. 2 | [BT. 709]                            | [BT. 709]                | Off                             | BT. 709         | BT. 709     |
|                 |                                      | [Wide DR]                |                                 |                 | Wide DR     |
|                 |                                      | [DCI]                    |                                 |                 | DCI         |
|                 |                                      | [Off]                    |                                 |                 | Canon Log   |
|                 | [DCI-P3+]                            | [BT. 709]                |                                 | DCI-P3+         | BT. 709     |
|                 |                                      | [Wide DR]                |                                 |                 | Wide DR     |
|                 |                                      | [DCI]                    |                                 |                 | DCI         |
|                 |                                      | [Off]                    |                                 |                 | Canon Log   |
|                 | [C. Gamut]                           | [BT. 709]                |                                 | Cinema Gamut    | BT. 709     |
|                 |                                      | [Wide DR]                |                                 |                 | Wide DR     |
|                 |                                      | [DCI]                    |                                 |                 | DCI         |
|                 |                                      | [Off]                    |                                 |                 | Canon Log   |
| MON. 2 only     | [BT. 709]<br>[DCI-P3+]<br>[C. Gamut] | [BT. 709]                | MON. 2                          | ACES            | ACESproxy10 |
|                 |                                      | [Wide DR]                |                                 |                 |             |
|                 |                                      | [DCI]                    |                                 |                 |             |
|                 |                                      | [Off]                    |                                 |                 |             |

<sup>1</sup> Refers to the LUT setting of the MON. terminals (□ 146).

<sup>2</sup> Refers to the ACESproxy10 setting of the MON. 2 terminal (□ 146).

## Connecting to an External Monitor

When you connect the camera to an external monitor for recording or playback, use the terminal on the camera that matches the one you wish to use on the monitor. Then, select the video signal output configuration (139). The camera can output video from all of the video output terminals simultaneously.

Operating modes: CAMERA MEDIA | 4K 2K MXF

### Connection Diagram

When you connect the camera to an external monitor using the SYNC OUT terminal, use headphones to monitor the sound (96).

We recommend that you power the camera from a household power outlet using the compact power adapter.

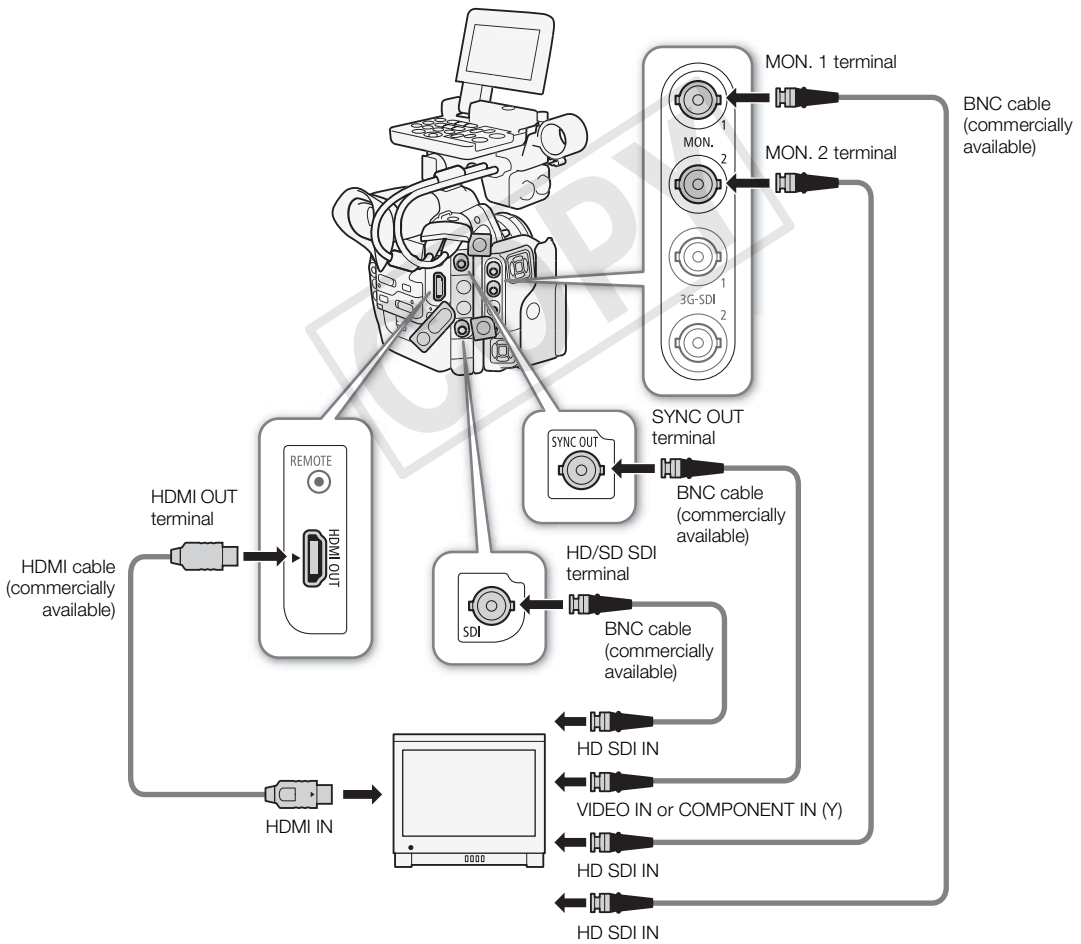



## Using the MON. 1 and MON. 2 Terminals

During 4K and 2K modes, the camera can output video from the MON. 1 and MON. 2 terminals (MON. terminals). The signal that is output from the MON. terminals also includes audio, time code, metadata and clip name information. In addition, the camera can apply onscreen markers, zebra patterns, peaking and magnification\* to the MON. 1 terminal output. Perform the following procedures to enable output from the MON. terminals and to adjust other related settings.

\* Magnification will simultaneously be applied to the MON. 2 terminal output.

Operating modes: CAMERA MEDIA | 4K 2K MXF

### Enabling Output from the MON. Terminals

- 1 Open the [Output] submenu.  
[4K/2K 4K/2K/MXF Setup] ➤ [MON. 1 & 2] ➤ [Output]
- 2 Select [On] and then press SET.
  - Output is enabled for the MON. terminals.
  - If you do not intend to use the MON. terminals, select [Off]. Doing so will also conserve the camera's power.

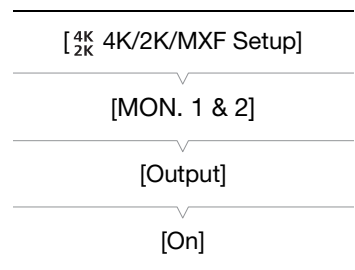

### Selecting the Resolution of the Output

When the resolution of the video configuration is [3840x2160], [3840x1080] or [1920x1080], the resolution of the output is automatically set to 1920x1080 so this procedure is not necessary.

- 1 Open the [Resolution] submenu.  
[4K/2K 4K/2K/MXF Setup] ➤ [MON. 1 & 2] ➤ [Resolution]
- 2 Select [2048x1080] or [1920x1080] and then press SET.

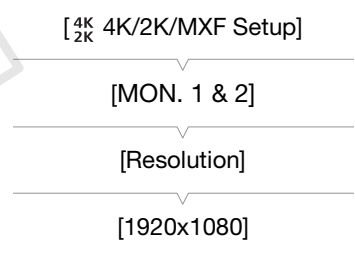

### Selecting the Scan Mode of the Output

When the recording mode of the video configuration is [HRAW], [4K1K RAW] or [CC422 10-bit], this procedure is not necessary because this function will be set automatically based on the resolution.

- 1 Open the [Scan Mode] submenu.  
[4K/2K 4K/2K/MXF Setup] ➤ [MON. 1 & 2] ➤ [Scan Mode]
- 2 Select [P] or [PsF] and then press SET.

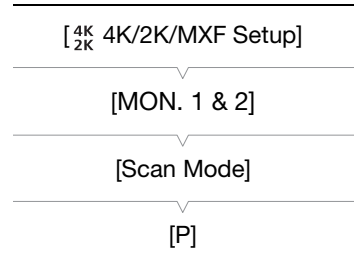

### Selecting the Resizing Method

When the recorded video and video output have a different aspect ratio, perform the following procedure to select how the video is output.

- 1 Open the [Resize Output] submenu.  
[4K/2K 4K/2K/MXF Setup] ➤ [MON. 1 & 2] ➤ [Resize Output]
- 2 Select the desired option and then press SET.

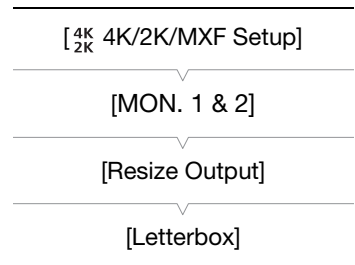

**Options**

- [Letterbox]: The picture is reduced in size while maintaining the aspect ratio and black letterbox bars are added to the top and bottom of the image so that the picture has a 16:9 aspect ratio.
- [Squeeze]: The image is squeezed from the left and right so that the entire image fits within the screen. The image will appear normal if the external monitor also has a 1.896:1 aspect ratio.
- [Side Crop]: The left and right sides of the image are cropped so that the central part of the image fits within the screen.



Original 4K or 2K image  
(1.896:1)



[Letterbox] setting

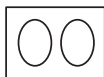

[Squeeze] setting



[Side Crop] setting

**NOTES**

- For [Letterbox], because the camera uses a simple conversion process vertically, diagonal lines may appear jagged.
- For MON. terminal output during 4K mode, because the camera uses a simple conversion process, color shifting may be visible.
- If you set an assignable button to [Resize MON. Output] (📖 111), you can press the button to switch the resizing method.

**Applying a LUT to Canon Log Gamma**

When checking video recorded with Canon Log gamma on an external monitor connected to a MON. terminal or the HD/SD-SDI terminal, you can apply a LUT.

- 1 Open the [Select] submenu (under [LUT]).  
 [4K/2K 4K/2K/MXF Setup] ➤ [MON. 1 & 2] or [HD/SD SDI] ➤ [Select]
- 2 Select the desired option and then press SET.
- 3 Press LUT.
  - The selected LUT will be applied.
  - You can also apply the LUT with the [4K/2K 4K/2K/MXF] ➤ [MON. 1 & 2] or [HD/SD SDI] ➤ [LUT]

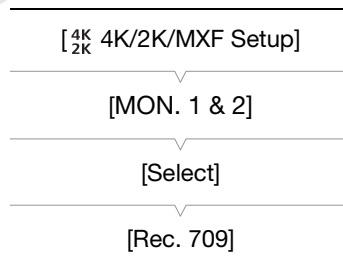

**Options**

- [BT. 709]: Converts to a gamma curve based on the ITU-R BT.709 standard.
- [Wide DR]: Converts to a gamma curve with a wide dynamic range.
- [DCI]: Converts to a gamma curve suitable for display on a monitor with a gamma of 2.6. Available from the MON. terminals only.

**Video Output Using ACESproxy10 (for On-set Color Grading)**

You can have the camera convert the video from the MON. 2 terminal to ACESproxy10-compliant video and output it. By checking the results with a compatible display device, you can see post-production video while on set.

- 1 Open the [ACESPX10] submenu.  
 [4K/2K 4K/2K/MXF] ➤ [MON. 1 & 2] ➤ [ACESPX10]
- 2 Select [MON. 2] and then press SET.
  - The video output from the MON. 2 terminal will be ACESproxy10-compliant.

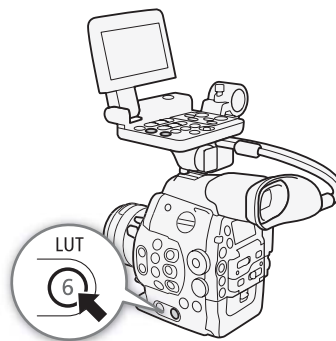

- Because this setting takes priority, the [4K/2K 4K/2K/MXF] ➤ [MON. 1 & 2] ➤ [LUT] setting will not be available.

## Using the HD/SD SDI Terminal

The digital signal output from the HD/SD SDI terminal includes the video signal, audio signal and time code signal. If necessary, perform the following procedure to change the output to HD or SD\*. Turning the output off will conserve the camera's power.

\* Not available for 24.00 Hz recordings.

Operating modes: CAMERA MEDIA

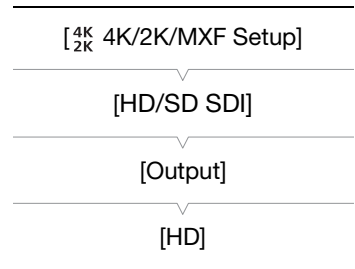

### 1 Open the [Output] submenu.

[4K/2K 4K/2K/MXF Setup] (in CAMERA mode) or [Video Setup] (in MEDIA mode) ➤ [HD/SD SDI] ➤ [Output]

### 2 Select the desired option and then press SET.

- If you selected [SD], you can select the SD resizing method (📖 148).
- If necessary, adjust the scan mode and resizing method with the [4K/2K 4K/2K/MXF Setup] ➤ [HD/SD SDI] ➤ [Scan Mode] and [4K/2K 4K/2K/MXF Setup] ➤ [Resize MXF Output] settings. Depending on the video configuration, the scan mode may be set automatically.
- If necessary, you can superimpose the onscreen displays on the video displayed on the external monitor (📖 149).

### **i** NOTES

- When you output from the HD/SD SDI terminal video in HD that was shot with Canon Log gamma, you can apply a LUT (📖 146).

## Using the HDMI OUT Terminal

The HDMI™ OUT terminal also offers a digital connection and outputs both a video and audio signal. The output signal will automatically switch to HD or SD\* depending on the capability of the external monitor. You can select the resizing method (📖 63) when the camera outputs HD video during 4K or 2K mode.

\* Not available for 24.00 Hz recordings.

### **i** NOTES

- Correct operation cannot be guaranteed when connecting the camera to DVI monitors.
- Video may not be output correctly depending on the monitor. In such case, use another terminal.
- The HDMI OUT terminal is output only. Do not connect the camera to another device's output terminal using the HDMI OUT terminal as this will cause a malfunction.
- If necessary, you can superimpose the onscreen displays on the video displayed on the external monitor (📖 149).
- You can select the SD resizing method (📖 148).

## Using the SYNC OUT Terminal

In addition to its function as a synchronization signal output terminal, you can use the SYNC OUT terminal also as a terminal for analog video signal output. You can output an HD component video luminance signal or a down-converted SD composite video signal\*.

\* Not available for 24.00 Hz recordings.

Operating modes: CAMERA MEDIA

### 1 Open the [Output] submenu.

[<sup>4K</sup>/<sub>2K</sub> 4K/2K/MXF Setup] (in CAMERA mode) or [ Video Setup] (in MEDIA mode) ➤ [SYNC OUT] ➤ [Output]

### 2 Select [HD-Y] or [Composite] and then press SET.

- If you selected [HD-Y] (HD component video, luminance signal), no more settings are necessary. If you selected [Composite] (SD analog composite signal), you can select the SD resizing method with the following procedure.
- If necessary, adjust the scan mode with the [<sup>4K</sup>/<sub>2K</sub> 4K/2K/MXF Setup] (in CAMERA mode) or [ Video Setup] (in MEDIA mode) ➤ [SYNC OUT] ➤ [Scan Mode] setting. You can adjust the scan mode only when [00:00 TC/UB Setup] ➤ [Time Code] ➤ [24P TC/Sync] is set to [Normal] and the recording mode is set to RAW, RGB444 12-bit or RGB444 10-bit.

### NOTES

- When you play back a clip on a monitor with a 4:3 aspect ratio, the monitor will switch automatically to widescreen mode if it is compatible with the Video ID-1 or WSS system.
- If necessary, you can superimpose the onscreen displays on the video displayed on the external monitor ( 149).

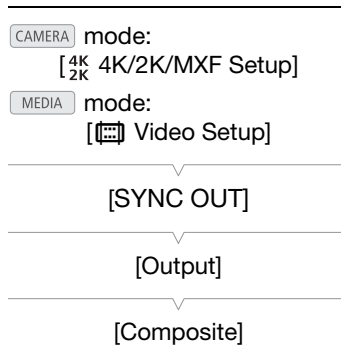

## Selecting the Resizing Method for SD Video

When HD video with a 16:9 aspect ratio is converted and output from the HD/SD SDI terminal, HDMI OUT terminal and SYNC OUT terminal as SD video with a 4:3 aspect ratio, you can choose how it appears on the external monitor.

Operating modes: CAMERA MEDIA | 4K 2K MXF

### 1 Open the [Resize SD Output] submenu.

[<sup>4K</sup>/<sub>2K</sub> 4K/2K/MXF Setup] (in CAMERA mode) or [ Video Setup] (in MEDIA mode) ➤ [HD/SD Output] ➤ [Resize SD Output]

### 2 Select the desired option and then press SET.

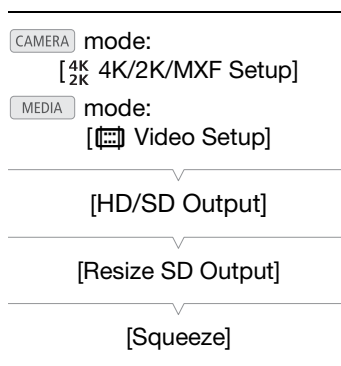

**Options**

- [Letterbox]: The picture is reduced in size while maintaining the aspect ratio and black letterbox bars are added to the top and bottom of the image so that the picture has a 4:3 aspect ratio.
- [Squeeze]: The image is squeezed from the left and right so that the entire image fits within the screen. The image will appear normal if the external monitor also has a 16:9 aspect ratio.
- [Side Crop]: The left and right sides of the image are cropped so that the central part of the image fits within the screen.



Original image (16:9)

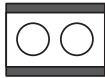

[Letterbox] setting

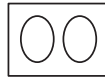

[Squeeze] setting



[Side Crop] setting

**Superimposing Onscreen Displays to Appear on an External Monitor**

You can choose to superimpose onscreen displays on the video output from the HD/SD SDI terminal, HDMI OUT terminal or SYNC OUT terminal. Doing so will display the onscreen displays on an external monitor. You must set this function separately for HD and SD output. This setting will not affect your recordings.

Operating modes: CAMERA MEDIA | 4K 2K MXF

**1 Open the [HD Onscreen Disp.] or [SD Onscreen Disp.] submenu.**

[ $\frac{4K}{2K}$  4K/2K/MXF Setup] (in CAMERA mode) or [ $\text{[Video Setup]}$ ] (in MEDIA mode) ➤ [HD/SD Output] ➤ [HD Onscreen Disp.] or [SD Onscreen Disp.]

**2 Select [On] and then press SET.**

- **DISP** appears on the upper right of the screen (when [ $\text{[LCD/VF Setup]}$ ] ➤ [Custom Display 2] ➤ [Output Display] is set to [On]).

**i NOTES**

- Onscreen displays will not appear on an external monitor for SD output if [ $\frac{4K}{2K}$  4K/2K/MXF Setup] (in CAMERA mode) or [ $\text{[Video Setup]}$ ] (in MEDIA mode) ➤ [Resize SD Output] is set to [Side Crop].
- If you set an assignable button to [Onscreen Display] ( $\text{[111]}$ ), you can press the button to turn on and off the superimposing of onscreen displays on video output from the camera's terminals (simultaneously for HD and SD video).

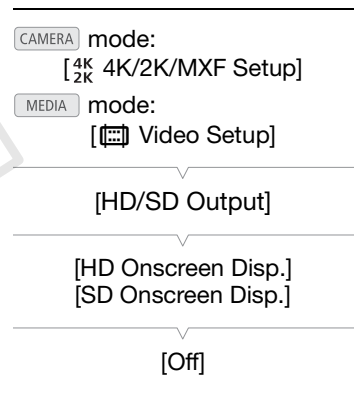

## Developing RAW Clips

Use the **Cinema RAW Development** software to develop RAW clips recorded on an external recorder connected to the camera's 3G-SDI terminals. After you develop the clips and export them to a full-quality standard file type such as DPX, they will be ready for color grading. Visit your local Canon Web site to download the software and receive the latest information on it. Refer to the instruction manual (PDF file) included with the software for details on its use.

Operating modes: CAMERA | MEDIA | 4K | 2K | MXF

### System Requirements

These are the system requirements as of October 2013.

The following are the minimum requirements.

|                                 |  |                                      |
|---------------------------------|--|--------------------------------------|
| OS <sup>1</sup>                 | Windows 7 SP1, Windows 8<br>(64-bit ver. only, regardless of OS) | Mac OS X v10.7 or 10.8 <sup>2</sup>  |
| CPU                             | Intel® Core i3/i5/i7 or Xeon                                     | -                                    |
| GPU                             | NVIDIA CUDA-compatible GPU <sup>3</sup>                          |                                      |
| RAM                             | 4 GB   |                                      |
| SDI expansion card <sup>4</sup> | AJA KONA 3G-SDI with drivers v10.3.2                             | AJA KONA 3G-SDI with drivers v10.4.2 |
| Display                         | 1024 x 768 resolution  |                                      |

The following are the recommended requirements for previewing RAW clips with a frame rate of 24 fps.

|                 |  |                                 |
|-----------------|--|---------------------------------|
| OS <sup>1</sup> | Windows 7 SP1, Windows 8<br>(64-bit ver. only, regardless of OS) | Mac OS X v10.8.3                |
| CPU             | Intel® Core i7, 3.06 GHz   | Intel® Xeon, 2.8 GHz, Quad Core |
| GPU             | NVIDIA GeForce GTX680  | NVIDIA Quadro K5000 for Mac     |
| RAM             | 16 GB  |                                 |
| Hard disk       | Any with read/write speed of 300 MB/s <sup>5</sup>               |                                 |

<sup>1</sup> The computer must have the listed OS pre-installed.

<sup>2</sup> The following models are not compatible: iMac (Late 2006), Mac mini (Mid 2007), MacBook (Late 2006, Mid 2007, Late 2007, Early 2008), MacBook Air (Early 2008).

<sup>3</sup> With a compute capability of 2.0 or higher. Computers without a compatible GPU will have decreased processing performance.

<sup>4</sup> Required only when checking SDI output on an external monitor.

<sup>5</sup> We recommend keeping RAW clips on a separate drive from the save destination of developed clips.

#### NOTES

- For details on precautions and restrictions, refer to the documentation supplied with Cinema RAW Development.

## Installing and Uninstalling Cinema RAW Development (Windows)

### Installing Cinema RAW Development

- 1 Double-click **crdw-\*\*\*\*.zip**, the file that you downloaded from the Canon Web site, to decompress it.
  - The folder **crdw-\*\*\*\*** will be created that contains the file **crdw\*\*\*.exe**.
- 2 Select your area.
- 3 Select your country/region and then click **Next**.
  - If you selected **Asia** or **Oceania** in step 2, skip to step 5.
- 4 Select the language to be displayed during installation.

- 5 After the message appears prompting you to exit other applications, exit other applications and then click **OK**.
  - The software's license agreement appears.
- 6 Read the license agreement and click **Yes** to begin the installation.
  - If you do not select **Yes**, you cannot install the software.
  - When the installation has completed, **Installation has completed successfully** appears.
- 7 Click **Next** and then click **Finish**.

### Uninstalling Cinema RAW Development

- 1 From the **Start** menu, select **All Programs > Canon Utilities > Cinema RAW Development > Uninstall Cinema RAW Development**.
  - A confirmation screen appears.
- 2 Click **OK** to begin uninstalling the software.
  - When the software has been uninstalled, **The software has been successfully uninstalled** appears.
- 3 Click **OK**.

## Installing and Uninstalling Cinema RAW Development (Mac OS)

### Installing Cinema RAW Development

- 1 Double-click **crdm-\*\*\*\*\*.dmg.gz**, the file that you downloaded from the Canon Web site, to decompress it.
  - The file **crdm-\*\*\*\*\*.dmg** will be created.
- 2 Double-click **crdm-\*\*\*\*\*.dmg**.
  - The **crdm\*\*\*** icon will appear on the desktop.
- 3 Double-click **crdm\*\*\*** and then double-click **CRDInstaller**.
- 4 Select your area.
- 5 Select your country/region and then click **Next**.
- 6 After the message appears prompting you to exit other applications, exit other applications and then click **OK**.
  - The software's license agreement appears.
- 7 Read the license agreement and click **Yes** to begin the installation.
  - If you do not select **Yes**, you cannot install the software.
  - When the installation has completed, **Installation has completed successfully** appears.
- 8 Click **Next** and then click **Finish**.

### Uninstalling Cinema RAW Development

- 1 From **Applications**, open **Canon Utilities**.
- 2 Move **Cinema RAW Development** to **Trash**.

## Viewing the Software Instruction Manual

For details on using the software, refer to the instruction manual (PDF file\*). The instruction manual is installed with the software.

\* Adobe Reader® is required to view the file.

### Windows:

- 1 From the **Start** menu, select **All Programs > Canon Utilities > Cinema RAW Development > Cinema RAW Development Instruction Manual**.
- 2 Select the language of the instruction manual to view.

Mac OS:

1 From **Applications**, open **Canon Utilities > Cinema RAW Development > Manual**.

2 Open the folder of the language and double-click the PDF file.

152

 NOTES

- You can also view the instruction manual by starting the **Cinema RAW Development** software and then selecting **Help > View Instruction Manual**.

COPY



## Saving MXF Clips to a Computer

Use the software on the supplied **Canon XF Utilities** CD-ROM to transfer MXF clips recorded on a CF card to a computer to save them. The CD-ROM contains the following.

- ① **Canon XF Utility:** Browser for transferring clips to a computer, playing back and checking video, and managing clips.
- ② **Plugins for non-linear editing (NLE) software:** The plugins allow you to transfer clips from a computer or a CF card (connected via USB reader to a computer) to the NLE software. The following plugins are included.
  - Avid's NLE software plugins (for computers running Windows or Mac OS)
    - Canon XF Plugin for Avid Media Access
    - Canon XF Plugin 64 for Avid Media Access
  - Apple's NLE software plugins (for computers running Mac OS)
    - Canon XF Plugin for Final Cut Pro
    - Canon XF Plugin for Final Cut Pro X

The instruction manual for each module provides more details. Refer to *Viewing the Software Instruction Manuals* (📖 159) for details on accessing the manuals. Refer to Web sites such as your local Canon Web site for the latest information on software.

Operating modes: CAMERA MEDIA

## System Requirements

### Canon XF Utility

|                           |   |  |
|---------------------------|---|--|
| OS                        | Windows XP <sup>1</sup> , SP3<br>Windows Vista <sup>2</sup> , SP2<br>Windows 7 <sup>2</sup> , with or without SP1 | Mac OS X v10.5 or 10.6 or 10.7                       |
| CPU                       | Intel® Core<br>(Intel® Core 2 Duo, 2.66 GHz recommended); SSE2 compatible   | Intel® CPU (Intel® Core 2 Duo, 2.66 GHz recommended) |
| RAM                       | 1 GB (2 GB for Windows 7, 64-bit version)   |  |
| Available hard disk space | Installation: 80 MB   |  |
| Display                   | 1024 x 768 resolution,<br>High-color (16-bit color)   | 1024 x 768 resolution,<br>32,000 colors              |

<sup>1</sup> 32-bit version only.

<sup>2</sup> 32-bit and 64-bit versions.

### Avid's NLE software plugins

Refer to the following for the required applications.

|  |   |
|--|---|
| Canon XF Plugin for Avid Media Access    | Media Composer 4.0.5 / 5.0 / 5.5 (Windows and Mac OS) |
|  | NewsCutter 8.0.5 / 9.0 / 9.5 (Windows only)           |
| Canon XF Plugin 64 for Avid Media Access | Media Composer 6.0 (Windows and Mac OS)               |
|  | NewsCutter 10.0 (Windows only)                        |

Refer to the application's official home page for the application's system requirements.

### Apple's NLE software plugins

Refer to the following for the required applications.

|                                     |                                      |
|-------------------------------------|--------------------------------------|
| Canon XF Plugin for Final Cut Pro   | Final Cut Pro 6.0.6 / 7.0.0 to 7.0.3 |
| Canon XF Plugin for Final Cut Pro X | Final Cut Pro X 10.0.3               |

Refer to the application's official home page for the application's system requirements.

### NOTES

- Even if your computer meets the system requirements, proper operation of the software cannot be guaranteed.

## Installing and Uninstalling Canon XF Utility (Windows)

### Installing Canon XF Utility

Perform the following procedure to install the **Canon XF Utility** software. Note that you can select the language used for the installation process from English, French, Spanish, Italian or German (available languages depend on the region you select).

- 1 Insert the Canon XF Utilities CD-ROM into the computer.
  - The installation screen appears. If it does not, follow the steps below.
    - Windows Vista and Windows 7: When the AutoPlay window appears, select **Run SETUP.EXE**.
    - Windows Vista, Windows 7 and Windows XP: Open **Computer** (Windows Vista and Windows 7) or **My Computer** (Windows XP) and double-click the icon of the drive that contains the CD-ROM.
- 2 Select your region.
  - If you selected **Asia** or **Oceania**, skip to step 4.



- 3 Select the language to be displayed during installation.

4 Select an installation method and then click **OK**.

- If you selected the **Easy Installation** installation method, skip to step 7.



5 Select the software to install and the destination folder. Then, click **Next**.



6 Click **Install**.



7 Read the license agreement and click **Yes** to begin the installation.

- If you do not select **Yes**, you cannot install the software.
- When the installation has completed, **Installation has completed successfully** appears.
- You can click **Cancel** to cancel the operation.

8 Click **Next** and then click **Finish**.

9 Remove the CD-ROM from the computer.

### Uninstalling Canon XF Utility

1 From the **Start** menu, select **All Programs > Canon Utilities > Canon XF Utility > Uninstall Canon XF Utility**.

- A confirmation screen appears.

2 Click **Yes** to begin the uninstalling the software.

- When the software has been uninstalled, **The software has been successfully uninstalled** appears.

3 Click **OK**.

### Uninstalling Canon XF Plugin for Avid Media Access or Canon XF Plugin 64 for Avid Media Access

- 1 In the Control Panel, open **Programs and Features\*** (Windows Vista/Windows 7) or **Add or Remove Programs** (Windows XP).
  - A list of installed programs appears.
- 2 Select the desired plugin.
- 3 Click **Uninstall** or **Uninstall/Change** (Windows Vista/Windows 7) or **Change/Remove** (Windows XP).
- 4 Follow the onscreen instructions.

\* This may be **Add or Remove Programs** depending on how the Control Panel is displayed.

### Uninstalling Canon XF MPEG2 Decoder

- 1 In the Control Panel, open **Programs and Features\*** (Windows Vista/Windows 7) or **Add or Remove Programs** (Windows XP).
  - A list of installed programs appears.
- 2 Select **Canon XF MPEG2 Decoder**.
- 3 Click **Uninstall** or **Uninstall/Change** (Windows Vista/Windows 7) or **Change/Remove** (Windows XP).
- 4 Follow the onscreen instructions.

\* This may be **Add or Remove Programs** depending on how the Control Panel is displayed.

### Uninstalling the Instructions for Avid's NLE Software Plugins

- 1 From the **Start** menu, open **All Programs > Canon Utilities > Desired plugin > Uninstall Canon XF Plugin for Avid Media Access Instruction Manual** or **Canon XF Plugin 64 for Avid Media Access Instruction Manual**.
- 2 When the confirmation screen appears, click **Yes** and then click **OK**.

## Installing and Uninstalling Canon XF Utility (Mac OS)

### Installing Canon XF Utility

- 1 Insert the Canon XF Utilities CD-ROM into the computer.
- 2 Open the Finder, click **CanonXF\*\*M** under **DEVICES** in the sidebar and double-click **MasterInstaller**.
  - The “\*\*” in the CD-ROM's name stands for the version number.
  - Mac OS X v10.5 or 10.6: The CD-ROM's icon will appear on the desktop. You can double click the icon and then double-click **MasterInstaller**.
  - The installation screen appears.
- 3 Select your region.



4 Click **Install**.



5 Select the installation method and then click **Next**.



6 Read the license agreement and click **Agree**.

- If you do not select **Agree**, you cannot install the software.
- If you selected the **Easy Installation** installation method, skip to step 8.

7 Select the software to install and then click **Next**.

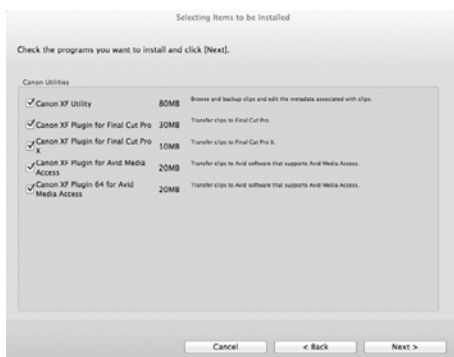

8 Click **Next** to begin the installation.



- When the installation has completed, **Installation has finished.** appears.

9 Click **Finish** and then remove the CD-ROM from the computer.

### Uninstalling the Software

1 From **Applications**, open **Canon Utilities**.

2 Move **Canon XF Utility** to **Trash**.

### Uninstalling Canon XF Plugin for Final Cut Pro

Move the following file to **Trash**.

/Library/Application Support/ProApps/MIO/RAD/Plugins/CanonXF.RADPlug

### Uninstalling Canon XF Plugin for Final Cut Pro X

Move the following file to **Trash**.

/Library/Application Support/ProApps/MIO/RADPlugins/CanonXF64.RADPlug

### Uninstalling Canon XF Plugin for Avid Media Access

Move the following file to **Trash**.

/Library/Application Support/Avid/AVX2\_Plug-ins/AMA/MVP\_CanonXF.avx

### Uninstalling Canon XF Plugin 64 for Avid Media Access

Move the following file to **Trash**.

/Library/Application Support/Avid/AVX2\_Plug-ins/AMA/MVP\_CanonXF64.avx

### Uninstalling Canon XF MPEG2 Decoder

Move the following file to **Trash**.

/Library/QuickTime/XFMpeg2Dec.component

### Uninstalling the Instructions for Apple's NLE Software Plugins

1 From **Applications**, open **Canon Utilities**.

2 Move **Canon XF Plugin for Final Cut Pro** or **Canon XF Plugin for Final Cut Pro X** to **Trash**.

### Uninstalling the Instructions for Avid's NLE Software Plugins

1 From **Applications**, open **Canon Utilities**.

- 2 Move **Canon XF Plugin for Avid Media Access** or **Canon XF Plugin 64 for Avid Media Access** to Trash.

## Viewing the Software Instruction Manuals

159

For details on using the software, refer to the instruction manual (PDF file) of each module. The instruction manuals are installed with the software. For computers running Windows, Adobe® Reader® is required.

### Viewing the Canon XF Utility Instruction Manual

Windows:

- 1 From the **Start** menu, select **All Programs > Canon Utilities > Canon XF Utility > Canon XF Utility Instruction Manual**.
- 2 Select the language of the instruction manual to view.

Mac OS:

- 1 From **Applications**, open **Canon Utilities > Canon XF Utility > Manual**.
- 2 Open the folder of the language and double-click the PDF file.

You can also view the instruction manual by starting the **Canon XF Utility** software and then selecting **Help > View Instruction Manual**.

### Viewing the Instructions for the NLE Software Plugins

Windows:

- 1 From the **Start** menu, select **All Programs > Canon Utilities > Desired plugin > Canon XF Plugin for Avid Media Access Instruction Manual** or **Canon XF Plugin 64 for Avid Media Access Instruction Manual**.
- 2 Select the desired language.

Mac OS:

- 1 From **Applications**, open **Canon Utilities > Desired plugin > Manual**.
- 2 Open the folder of the language and double-click the PDF file.

COPY



## Taking Photos

You can take photos when the camera is in **CAMERA** mode or you can capture a photo from an MXF clip when the camera is in **MEDIA** mode. Photos are saved onto the SD card. In **CAMERA** mode, photo size is 1920x1080\* or 1920x540\*\*. In **MEDIA** mode, photo size depends on the resolution setting of the clip that the photo is captured from. If the clip is 1920x1080 or 1440x1080, the photo size is 1920x1080. If the clip is 1280x720, the photo size is 1280x720.

\* At this size, the camera can save approximately 670 photos on a 1 GB SD card. Also, during 4K and 2K modes, if [**4K** 4K/2K/MXF Setup] ➤ [Resize MXF Output] is set to [Letterbox], the picture angle will differ.

\*\* Only when [**4K** 4K/2K/MXF Setup] ➤ [4K (4096/3840)] ➤ [Mode] is set to [4K1K RAW].

### Taking Photos in CAMERA Mode

You can take a photo while the camera is recording a clip or is in record pause mode. If a custom picture file is selected in advance, it will be recorded with the photo (📖 114). To take a photo, set an assignable button to [Photo] in advance.

Operating modes: **CAMERA** **MEDIA** | **4K** **2K** **MXF**

- 1 Set an assignable button to [Photo] (📖 111).
- 2 Press the assignable button to take a photo.
  - 📷 and the number of available photos appear on the upper right of the screen.
  - If a custom picture file is selected, it will be recorded with the photo.
  - The SD card access indicator will flash as the photo is being recorded.

#### **i** NOTES

- Photo recording is disabled while Wi-Fi communication is turned on ([📶 Other Functions] ➤ [Wi-Fi Remote] ➤ [Select] is set to a setting other than [Off]).

### Capturing Photos in MEDIA Mode

You can capture a photo from an MXF clip during playback pause. To capture a photo, set an assignable button to [Photo] in advance.

Operating modes: **CAMERA** **MEDIA**

- 1 Set an assignable button to [Photo] (📖 111).
- 2 Select the desired MXF clip and press the ▶/|| button to start playback.
- 3 Pause the playback at the point you want to capture.
- 4 Press the assignable button to capture a photo.
  - The screen will momentarily turn black as if a camera shutter had released.
  - 📷 and the number of available photos appear on the upper right of the screen.
  - The SD card access indicator will flash as the photo is being recorded.
- 5 Press the ■ button to stop playback.

**!** IMPORTANT

- Observe the following precautions while the SD card access indicator is flashing. Failure to do so may result in permanent data loss.
  - Do not disconnect the power source or turn off the camera.
  - Do not remove the SD card.

**i** NOTES

- If the LOCK switch on the SD card is set to prevent writing, you will not be able to record a photo. Change the position of the LOCK switch in advance.
- Even if [Other Functions] ➤ [Custom Function] ➤ [Scan Reverse Rec] is set to a setting other than [Off], photos will not be inverted.

COPY

## Photo Playback

You can view the photos that you took with the camera.

Operating modes: CAMERA MEDIA

### Displaying the [Photos] Index Screen

Display the [Photos] index screen to view photos.

- 1 Set the **POWER** switch to **MEDIA**.
  - The camera switches to MEDIA mode and the clip index screen appears.
- 2 Press the **INDEX** button.
  - The index screen selection menu appears.
- 3 Select [Photo Index] and then press **SET**.
  - The [Photos] index screen appears.
  - After you are finished viewing photos, press the **INDEX** button to return to the clip index screen.

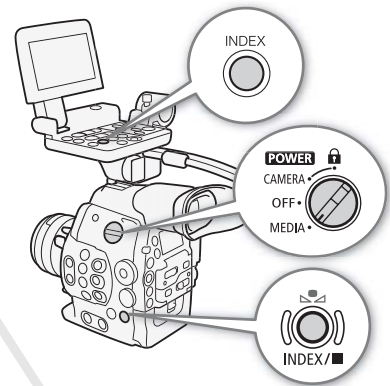

### Viewing Photos

- 1 Move the orange selection frame to the desired photo.
- 2 Press the **▶/||** button to view the photo.
  - The photo playback screen appears and the selected photo is displayed.
  - Use the **◀◀/▶▶** buttons or push the joystick left/right to switch to the previous/next photo.
  - Press the **DISP.** button to hide/show the onscreen displays.
  - Press the **■** button to return to the [Photos] index screen.

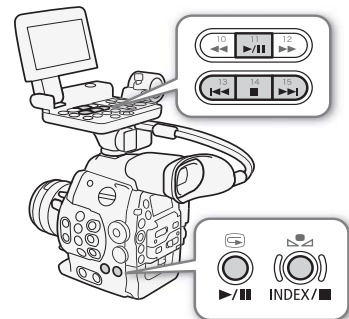

#### ! IMPORTANT

- Observe the following precautions while the SD card access indicator is flashing. Failure to do so may result in permanent data loss.
  - Do not disconnect the power source or turn off the camera.
  - Do not remove the SD card.

#### i NOTES

- The following photos may not be displayed correctly.
  - Photos not recorded with this camera.
  - Photos created or edited on a computer.
  - Photos whose file names have been changed.

## Photo Operations

You can use the photo menu to delete a photo, protect or unprotect a photo, or copy a custom picture file embedded in a photo. You can display the photo menu from the [Photos] index screen or photo playback screen.

### Using the Photo Menu

1 From the [Photos] index screen, select a photo and then press SET.

- If you are viewing a photo, simply press SET.
- The photo menu appears. Available functions depend on the photo's settings.

2 Select the desired function and then press SET.

### Deleting Photos

You can delete a photo you no longer need. When you do so, however, the custom picture file embedded in it will also be deleted. Photos can be deleted one at a time from the photo playback screen or [Photos] index screen.

Operating modes:

#### Deleting a Photo from the Playback Screen

1 Display the photo to be deleted (📖 163).

2 Press SET to open the photo menu.

3 Select [Delete] and then press SET.

- The screen prompts you to confirm the operation.

4 Select [OK] and then press SET.

- Select [Cancel] instead to cancel the operation.
- The selected photo is deleted and the next photo is displayed.
- If a custom picture file is embedded in the photo, it is also deleted.

5 When the confirmation message appears, press SET.

#### Deleting a Photo from the Index Screen

1 Open the [Photos] Index Screen (📖 163).

2 Move the orange selection frame to the photo to be deleted.

3 Press SET to open the photo menu.

4 Select [Delete] and then press SET.

- The screen prompts you to confirm the operation.

5 Select [OK] and then press SET.

- Select [Cancel] instead to cancel the operation.
- The selected photo is deleted.
- If a custom picture file is embedded in the photo, it is also deleted.

6 When the confirmation message appears, press SET.

## Deleting All Photos

- 1 Display the [Photos] index screen or a photo (📖 163).
- 2 Open the [Delete All Photos] submenu.  
[👉 Other Functions] ➡ [Delete All Photos]
- 3 Select [OK] and then press SET.
  - All of the photos on the SD card, except for protected ones, will be deleted.
  - Select [Cancel] instead to cancel the operation.
  - While the photos are being deleted, you can press SET to cancel.
- 4 When the confirmation message appears, press SET.

---

[👉 Other Functions]

---

[Delete All Photos]

---

165

### ! IMPORTANT

- Be careful when deleting photos. Deleted photos cannot be recovered.

## Protecting Photos

You can protect photos to prevent accidental erasure. The custom picture file embedded in such a photo is also protected. Photos can be protected from the photo playback screen or [Photos] index screen.

Operating modes: CAMERA MEDIA

### Protecting a Photo from the Playback Screen

- 1 Display the photo to be protected (📖 163).
- 2 Press SET to open the photo menu.
- 3 Select [Protect] and then press SET.
  - To remove protection settings from a protected photo, select [Unprotect] instead.
  - The screen prompts you to confirm the operation.
- 4 Select [OK] and then press SET.
  - Select [Cancel] instead to cancel the operation.
  - The selected photo is protected and  appears on the lower left of the screen.
  - If a custom picture file is embedded in the photo, it is also protected.

### Protecting a Photo from the Index Screen

- 1 Open the [Photos] Index Screen (📖 163).
- 2 Move the orange selection frame to the photo to be protected.
- 3 Press SET to open the photo menu.
- 4 Select [Protect] and then press SET.
  - To remove protection settings from a protected photo, select [Unprotect] instead.
  - The screen prompts you to confirm the operation.
- 5 Select [OK] and then press SET.
  - The selected photo is protected and  appears next to the photo's thumbnail.
  - Select [Cancel] instead to cancel the operation.
  - If a custom picture file is embedded in the photo, it is also protected.

**!** IMPORTANT

- Initializing an SD card will permanently erase all the data it contains, including protected photos and custom picture files.

## Copying Custom Picture Files

You can copy to the camera a custom picture file embedded in a photo. Custom picture files can be copied from the photo playback screen or [Photos] index screen.

Operating modes: CAMERA MEDIA

### Copying a File from the Playback Screen

- 1 Display the photo with the custom picture file to be copied (📖 163).
- 2 Press SET to open the photo menu.
- 3 Select [Copy **CP** File] and then press SET.
  - The [**CP** Data 1/3] screen appears with the orange selection frame indicating a file slot in the camera.
  - Alternatively, you can press the CUSTOM PICTURE button.
  - You can push the joystick up/down or turn the SELECT dial to display the [**CP** Data 2/3] and [**CP** Data 3/3] screens.
- 4 Push the joystick left/right to select the desired file slot and then press SET.
- 5 Select [OK] and then press SET.
  - The custom picture file embedded in the selected photo is copied, overwriting the file in that slot.
  - Select [Cancel] instead to cancel the operation.
- 6 When the confirmation message appears, press SET.

### Copying a File from the Index Screen

- 1 Open the [Photos] Index Screen (📖 163).
- 2 Move the orange selection frame to the photo with the custom picture file to be copied.
- 3 Press SET to open the photo menu.
- 4 Select [Copy **CP** File] and then press SET.
  - The [**CP** Data 1/3] screen appears with the orange selection frame indicating a file slot in the camera.
  - Alternatively, you can press the CUSTOM PICTURE button.
  - You can push the joystick up/down or turn the SELECT dial to display the [**CP** Data 2/3] and [**CP** Data 3/3] screens.
- 5 Push the joystick left/right to select the desired file slot and then press SET.
- 6 Select [OK] and then press SET.
  - The custom picture file embedded in the selected photo is copied, overwriting the file in that slot.
  - Select [Cancel] instead to cancel the operation.
- 7 When the confirmation message appears, press SET.

**i** NOTES

- You cannot copy the custom picture file to a file slot with a protected file.
- By default, file slots [C8] and [C9] are protected.

## Photo Numbering

Photos are automatically assigned consecutive numbers from 0101 to 9900, and stored on the SD card in folders containing up to 100 photos. Folders are numbered from 101 to 998. You can select the photo numbering method to be used.

The photo number indicates the name and location of the file on the SD card. For example, a photo numbered 101-0107 is located in the "DCIM\101\CANON" folder as the file "IMG\_0107.jpg".

Operating modes: CAMERA MEDIA

1 Open the [Photo Numbering] submenu.

[ Other Functions] [Photo Numbering]

2 Select the desired option and the press SET.

### Options

[Reset]: Photo numbers will restart from 101-0101 every time you insert a new SD card. If an SD card already contains photos, photo numbers will continue from the number following that of the last photo on the SD card.

[Continu.]: Photo numbers will continue from the number following that of the last photo recorded with the camera.

### NOTES

- If you select [Continu.] and the SD card you insert already contains a photo with a larger number, a new photo will be assigned a number one higher than that of the last photo on the SD card.
- We recommend using the [Continu.] setting.

---

[ Other Functions]

---

[Photo Numbering]

---

[Continu.]

---

COPY



## Menu Options

For details about how to select an item, refer to *Using the Menus* (□ 29). For details about each function, see the reference page. Menu items without a reference page are explained after the tables. Setting options in boldface indicate default values. Menu items not available appear grayed out.

To skip directly to the page of a specific menu:

|                             |       |
|-----------------------------|-------|
| [ Camera Setup] menu        | □ 169 |
| [ 4K/2K/MXF Setup] menu     | □ 169 |
| [ Video Setup] menu         | □ 172 |
| [ Audio Setup] menu         | □ 173 |
| [ LCD/VF Setup] menu        | □ 173 |
| [00:00 TC/UB Setup] menu    | □ 176 |
| [00:00 User Bit Setup] menu | □ 176 |
| [ Other Functions] menu     | □ 177 |
| [ My Menu] customized menu  | □ 179 |

[ Camera Setup] menu (CAMERA mode only)

| Menu item                          | Submenu              | Setting options                               | □   |
|------------------------------------|----------------------|---|-----|
| [ISO/Gain]                         | [Select]             | [ISO], [Gain]                                 | 70  |
|                                    | [Extended Range]     | [On], [Off]                                   |     |
|                                    | [ISO Increment]      | [1 stop], [1/3 stop]                          |     |
|                                    | [Gain]               | [Normal], [Fine]                              |     |
| <b>C500</b> [Iris]                 | [Iris Increment]     | [1/2 stop], [1/3 stop], [Fine]                | 74  |
|                                    | [Zoom-Iris Correct.] | [On], [Off]                                   |     |
| [Shutter]                          | [Mode]               | [Speed], [Angle], [Clear Scan], [Slow], [Off] | 67  |
|                                    | [Shutter Increment]  | [1/3 stop], [1/4 stop]                        |     |
| [Color Space]                      |                      | [BT. 709], [DCI-P3+], [C. Gamut]              | 142 |
| [ CINEMA Locked]                   |                      | [On], [Off]                                   | 58  |
| [ABB]                              |                      | [Cancel], [OK]                                | 48  |
| [Color Bars]                       | [Enable]             | [On], [Off]                                   | 99  |
|                                    | [Type]               | [SMPTE], [EBU]*, [ARIB]                       |     |
| <b>C500</b> [Periph. Illum. Corr.] |                      | [On], [Off]                                   | 34  |

\* The default value depends on the country/region or purchase.

[ 4K/2K/MXF Setup] menu (CAMERA mode only)

| Menu item          | Submenu | Setting options                                  | □  |
|--------------------|---------|--|----|
| [System Priority]  |         | [4K], [2K], [MXF]                                | 60 |
| [System Frequency] |         | [59.94 Hz], [50.00 Hz] <sup>1</sup> , [24.00 Hz] | 60 |

| Menu item                        | Submenu                            | Setting options  |  |
|----------------------------------|------------------------------------|--|---|
| [4K (4096/3840)]                 | [Mode] <sup>2</sup>                | <b>[RAW]</b> , [HRAW], [4K1K RAW]  | 60  |
|                                  | [Resolution] <sup>2</sup>          | When [Mode] is set to [RAW]:<br><b>[4096x2160]</b> , [3840x2160]<br>When [Mode] is set to [HRAW]:<br><b>[4096x1080]</b> , [3840x1080]<br>When [Mode] is set to [4K1K RAW]:<br><b>[4096x1080]</b>   | 62  |
|                                  | [Frame Rate] <sup>2</sup>          | For 59.94 Hz recordings:<br>[59.94P], [29.97P], <b>[23.98P]</b><br>For 50.00 Hz recordings:<br>[50.00P], <b>[25.00P]</b><br>For 24.00 Hz recordings, the frame rate is set to [24.00P] and cannot be changed.                            | 62  |
| [2K (2048/1920)]                 | [Mode] <sup>3</sup>                | <b>[RGB444 12-bit]</b> , [RGB444 10-bit], [YCC422 10-bit] <sup>8</sup>   | 60  |
|                                  | [Resolution] <sup>3</sup>          | <b>[2048x1080]</b> , [1920x1080]   | 62  |
|                                  | [Frame Rate] <sup>3</sup>          | For 59.94 Hz recordings:<br>[59.94P], [29.97P], <b>[23.98P]</b><br>For 50.00 Hz recordings:<br>[50.00P], <b>[25.00P]</b><br>For 24.00 Hz recordings, the frame rate is set to [24.00P] and cannot be changed.                            | 62  |
| [MXF]                            | [Bit Rate/Resolution] <sup>4</sup> | <b>[50 Mbps 1920x1080]</b> , [50 Mbps 1280x720], [35 Mbps 1920x1080], [35 Mbps 1280x720], [25 Mbps 1440x1080]  | 64  |
|                                  | [Frame Rate] <sup>4, 5, 6</sup>    | For 59.94 Hz recordings:<br>[59.94i], [59.94P], [29.97P], <b>[23.98P]</b><br>For 50.00 Hz recordings:<br>[50.00i], [50.00P], <b>[25.00P]</b><br>For 24.00 Hz recordings, the frame rate is set to [24.00P] and cannot be changed.        | 62  |
| [Resize MXF Output] <sup>7</sup> |                                    | <b>[Letterbox]</b> , [Squeeze], [Side Crop]  | 63  |
| [Special Rec]                    |                                    | [Interval Rec], [Frame Rec], [Pre Rec] <sup>5</sup> , [Slow & Fast Motion], <b>[Off]</b>   | 105   |
| [Interval Rec]                   | [Interval]                         | <b>[1 sec]</b> to [10 sec], [15 sec], [20 sec], [30 sec], [40 sec], [50 sec], [1 min] to [10 min]  | 105   |
|                                  | [Rec Frames]                       | During 4K or 2K mode, or MXF mode when [Frame Rate] is set to [59.94i], [29.97P], [23.98P] or [24.00P]:<br><b>1, 3, 6, 9</b><br>During MXF mode when [Frame Rate] is set to [59.94P], [50.00i], [50.00P] or [25.00P]:<br><b>2, 6, 12</b> | 105   |
| [Frame Rec]                      | [Rec Frames]                       | During 4K or 2K mode, or MXF mode when [Frame Rate] is set to [59.94i], [29.97P], [23.98P] or [24.00P]:<br><b>1, 3, 6, 9</b><br>During MXF mode when [Frame Rate] is set to [59.94P], [50.00i], [50.00P] or [25.00P]:<br><b>2, 6, 12</b> | 106   |

| Menu item                    | Submenu                  | Setting options  |     |
|------------------------------|--------------------------|--|-----|
| [S&F Frame Rate]             |                          | <p>During 4K mode when [Mode] is set to [RAW], or 2K mode when [Mode] is set to [RGB444 12-bit] or [RGB444 10-bit]:</p> <p>For 59.94 Hz and 24.00 Hz recordings:<br/>[1] to [30], [32] to [60]* ([24])</p> <p>For 50.00 Hz recordings:<br/>[1] to [25], [26] to [50]* ([24])</p> <p>During 4K mode when [Mode] is set to [HRAW] / [4K1K RAW], or 2K mode when [Mode] is set to [YCC422 10-bit]:</p> <p>For 59.94 Hz and 24.00 Hz recordings:<br/>[1] to [60], [62] to [120]* ([24])</p> <p>For 50.00 Hz recordings:<br/>[1] to [50], [52] to [100]* ([24])</p> <p>During MXF mode when [Bit Rate/Resolution] is set to an option with 1080 vertical resolution:</p> <p>For 59.94 Hz and 24.00 Hz recordings:<br/>[1] to [30]</p> <p>For 50.00 Hz recordings:<br/>[1] to [25]</p> <p>During MXF mode when [Bit Rate/Resolution] is set to an option with 720 vertical resolution:</p> <p>For 59.94 Hz and 24.00 Hz recordings:<br/>[1] to [60], ([30])</p> <p>For 50.00 Hz recordings:<br/>[1] to [50], ([25])</p> <p>* This range is in 2 fps increments. When the shooting frame rate appears in brackets on the screen, this indicates that both 3G-SDI terminals are required for output.</p> | 108 |
| [Clip Name]                  | [Title Prefix]           | Two characters, each:<br>[A] to [Z], [0] to [9] ([AA])   | -   |
|                              | [Number Setting]         | [Set], [Reset] ([0001])  | -   |
| [Metadata]                   | [Setting]                | [Remote], [SD Card]  | 97  |
|                              | [User Memo]              | [Off], list of user memo files available on the SD card  |     |
|                              | [Country Code]           | Letters A to Z, numbers 0 to 9, plus sign (+), minus sign (-), colon (:), space  |     |
|                              | [Organization]           |  | -   |
|                              | [User Code]              |  |     |
| [3G-SDI Output] <sup>7</sup> |                          | [On], [Off]  | 41  |
| [MON. 1 & 2] <sup>7</sup>    | [Output]                 | [On], [Off]  | 145 |
|                              | [LUT]                    | [On], [Off]  | 146 |
|                              | [Select]                 | [BT. 709], [Wide DR], [DCI]  |     |
|                              | [ACESPX10]               | [Off], [MON. 2]  | 146 |
|                              | [Resolution]             | [2048x1080], [1920x1080]   | 145 |
|                              | [Resize Output]          | [Letterbox], [Squeeze], [Side Crop]  | 145 |
|                              | [Scan Mode] <sup>6</sup> | [P], [PsF]   | 145 |
| [MON. 1] <sup>7</sup>        | [Peaking Gain]           | [Off], [1] to [15] ([10])  | 80  |
| [HD/SD SDI]                  | [Output]                 | [HD], [SD] <sup>8</sup> , [Off]  |     |
|                              | [LUT]                    | [On], [Off]  | 147 |
|                              | [Select]                 | [BT. 709], [Wide DR]   |     |
|                              | [Scan Mode]              | [P], [PsF]   |     |
| [SYNC OUT]                   | [Output]                 | [HD-Y], [HD Sync], [Blk Burst] <sup>8</sup> , [Composite] <sup>8</sup> , [Off]   | 148 |
|                              | [Scan Mode]              | [P], [PsF]   |     |

| Menu item          | Submenu                         | Setting options                             |  |
|--------------------|---------------------------------|---|---|
| [HD/SD Output]     | [HD Onscreen Disp.]             | [On], <b>[Off]</b>                          | 149   |
|                    | [Zebra HD Output]               | [On], <b>[Off]</b>                          | 83  |
|                    | [SD Onscreen Disp.]             | [On], <b>[Off]</b>                          | 149   |
|                    | [Resize SD Output] <sup>8</sup> | [Letterbox], <b>[Squeeze]</b> , [Side Crop] | 148   |
| [Rec Command]      |                                 | [On], [Off]                                 | –   |
| [Set CF Card Slot] | [Relay Rec]                     | [On], [Off]                                 | 46  |
|                    | [Double Slot Rec]               | [On], <b>[Off]</b>                          |   |

<sup>1</sup> The default value depends on the country/region or purchase.

<sup>2</sup> Available during 4K mode only.

<sup>3</sup> Available during 2K mode only.

<sup>4</sup> Available options depend on the system priority and system frequency settings.

<sup>5</sup> Available during MXF mode only.

<sup>6</sup> Available options depend on the system frequency and resolution settings.

<sup>7</sup> Available during 4K and 2K modes only.

<sup>8</sup> Not available for 24.00 Hz recordings.

### [Clip Name] settings

**[Title Prefix]:** Determines the first 2 characters of the clip name. Combined with the [Number Setting] setting, this constitutes the 6-character clip name.

**[Number Setting]:** Determines the last 4 digits of the clip name. Combined with the [Title Prefix] setting, this constitutes the 6-character clip name. Select [Set] to assign a desired number to the first clip you record or select [Reset] to reset the number to [0001].

The numerals increase every time a clip is recorded.

**[Country Code]:** This identifier is the country code defined by ISO-3166-1 and is to be entered starting from the left.

**[Organization]:** This identifier represents the organization that owns or operates the camera and can be obtained by registering with the SMPTE Registration Authority. If the organization is not registered, enter [0000].

**[User Code]:** This identifier designates the user. Leave this blank if [Organization] is set to [0000].

**[Rec Command]:** When you connect the camera to another device using the 3G-SDI terminals (during 4K and 2K modes) or HD/SD SDI terminal (during MXF mode), if you start or stop recording with the camera, the other device will also start or stop recording.

### [ Video Setup] menu ( mode only )

| Menu item          | Submenu                         | Setting options   |  |
|--------------------|---------------------------------|---|---|
| [System Frequency] |                                 | <b>[59.94 Hz]</b> , <b>[50.00 Hz]</b> <sup>1</sup> , [24.00 Hz]                       | 60,<br>64   |
| [HD/SD SDI]        | [Output]                        | <b>[HD]</b> , [SD] <sup>2</sup> , [Off]   | 147   |
|                    | [Scan Mode]                     | <b>[P]</b> , [PsF]  |   |
| [SYNC OUT]         | [Output]                        | [HD-Y], [HD Sync], [Blk Burst] <sup>2</sup> , <b>[Composite]</b> <sup>2</sup> , [Off] | 148   |
|                    | [Scan Mode]                     | <b>[P]</b> , [PsF]  |   |
| [HD/SD Output]     | [HD Onscreen Disp.]             | [On], <b>[Off]</b>  | 149   |
|                    | [SD Onscreen Disp.]             | [On], <b>[Off]</b>  | 149   |
|                    | [Resize SD Output] <sup>2</sup> | [Letterbox], <b>[Squeeze]</b> , [Side Crop]   | 148   |

<sup>1</sup> The default value depends on the country/region of purchase.

<sup>2</sup> Not available for 24.00 Hz recordings.

## [🎧] Audio Setup] menu

| Menu item      | Submenu             | Setting options                              | CAMERA      | MEDIA |           |
|----------------|---------------------|--|-------------|-------|-----------|
| [Audio Input]  | [XLR Rec Channel]   | [CH1], [CH1/CH2]                             | ●           | –     | 93        |
|                | [XLR1 Mic Trimming] | [+12 dB], [+6 dB], [0 dB], [-6 dB], [-12 dB] | ●           | –     | 95        |
|                | [XLR2 Mic Trimming] |  | ●           | –     |           |
|                | [XLR1 Mic Att.]     | [On], [Off]                                  | ●           | –     | 95        |
|                | [XLR2 Mic Att.]     |  | ●           | –     |           |
|                | [XLR ALC Link]      | [Linked], [Separated]                        | ●           | –     | 94        |
|                | [Limiter]           | [On], [Off]                                  | ●           | –     | 94,<br>95 |
|                | [1 kHz Tone]        | [-12 dB], [-18 dB], [-20 dB], [Off]          | ●           | –     | 99        |
|                | [MIC Mode]          | [Automatic], [Manual]                        | ●           | –     | 95        |
|                | [MIC Level]         | 0 to 99 (50)                                 | ●           | –     |           |
|                |                     | [MIC Att.]                                   | [On], [Off] | ●     | –         |
| [Audio Output] | [Channel]           | [CH1/CH2], [CH1/CH1], [CH2/CH2], [All/All]   | ●           | ●*    | 96        |
|                | [Headphone Volume]  | [Off], 1 to 15 (8)                           | ●           | ●*    | 129       |

\* Not available in the [Photos] index screen.

## [📺 LCD/VF Setup] menu

| Menu item                | Submenu              | Setting options                  | CAMERA | MEDIA |    |
|--------------------------|----------------------|----------------------------------|--------|-------|----|
| [LCD Setup]              | [Brightness]         | -99 to 99 (±0)                   | ●      | ●     | 38 |
|                          | [Contrast]           | -99 to 99 (±0)                   | ●      | ●     |    |
|                          | [Color]              | -20 to 20 (±0)                   | ●      | ●     |    |
|                          | [Sharpness]          | 1 to 4 (2)                       | ●      | ●     |    |
|                          | [Backlight]          | [Normal], [Bright]               | ●      | ●     |    |
| [VF Setup]               | [Brightness]         | -99 to 99 (±0)                   | ●      | ●     | 38 |
|                          | [Contrast]           | -99 to 99 (±0)                   | ●      | ●     |    |
|                          | [Color]              | -20 to 20 (±0)                   | ●      | ●     |    |
|                          | [Sharpness]          | 1 to 4 (2)                       | ●      | ●     |    |
|                          | [Backlight]          | [Normal], [Bright]               | ●      | ●     |    |
| [LCD/VF B&W]             |                      | [On], [Off]                      | ●      | ●     | 38 |
| [LCD/VF Simul.]          |                      | [On], [Off]                      | ●      | ●     | 37 |
| [View Assist.]           |                      | [On], [Off]                      | ●      | –     | 58 |
| [Peaking] <sup>1</sup>   |                      | [On], [Off]                      | ●      | –     | 80 |
| [Select] <sup>1</sup>    |                      | [Peaking 1], [Peaking 2]         | ●      | –     |    |
| [Peaking 1]              | [Color] <sup>1</sup> | [White], [Red], [Yellow], [Blue] | ●      | –     |    |
|                          | [Gain]               | [Off], 1 to 15 (8)               | ●      | –     |    |
|                          | [Frequency]          | 1 to 4 (2)                       | ●      | –     |    |
| [Peaking 2] <sup>1</sup> | [Color] <sup>1</sup> | [White], [Red], [Yellow], [Blue] | ●      | –     |    |
|                          | [Gain]               | [Off], 1 to 15 (15)              | ●      | –     |    |
|                          | [Frequency]          | 1 to 4 (1)                       | ●      | –     |    |

| Menu item                    | Submenu                    | Setting options  | CAMERA | MEDIA          |    |
|------------------------------|----------------------------|--|--------|----------------|----|
| [Zebra] <sup>1</sup>         |                            | [On], <b>[Off]</b>   | ●      | –              | 83 |
| [Select] <sup>1</sup>        |                            | <b>[Zebra 1]</b> , [Zebra 2], [Zebra 1&2]                            | ●      | –              |    |
| [Zebra 1 Level] <sup>1</sup> |                            | <b>[70 ±5%]</b> , [75 ±5%], [80 ±5%], [85 ±5%], [90 ±5%], [95 ±5%]   | ●      | –              |    |
| [Zebra 2 Level] <sup>1</sup> |                            | [70%], [75%], [80%], [85%], [90%], [95%], <b>[100%]</b>              | ●      | –              |    |
| [Markers] <sup>1</sup>       | [Enable]                   | [On], <b>[Off]</b>   | ●      | –              | 82 |
|                              | [Center]                   | [White], [Gray], <b>[Off]</b>  | ●      | –              |    |
|                              | [Horizontal]               | [White], [Gray], <b>[Off]</b>  | ●      | –              |    |
|                              | [Grid]                     | [White], [Gray], <b>[Off]</b>  | ●      | –              |    |
|                              | [Safety Zone]              | [White], [Gray], <b>[Off]</b>  | ●      | –              |    |
|                              | [Safety Zone Area]         | [80%], [90%], [92.5%], <b>[95%]</b>                                  | ●      | –              |    |
|                              | [Aspect Marker]            | [White], [Gray], <b>[Off]</b>  | ●      | –              |    |
|                              | [Aspect Ratio]             | [4:3], [13:9], [14:9], [1.66:1], [1.75:1], [1.85:1], <b>[2.35:1]</b> | ●      | –              |    |
| [Audio Level]                |                            | <b>[On]</b> , [Off]  | –      | ● <sup>2</sup> | –  |
| [Custom Display 1]           | [Custom Picture]           | <b>[On]</b> , [Off]  | ●      | –              | –  |
|                              | <b>C500</b> [Focal Length] | <b>[On]</b> , [Off]  | ●      | –              |    |
|                              | [ND Filter]                | <b>[On]</b> , [Off]  | ●      | –              |    |
|                              | [Key Lock]                 | <b>[On]</b> , [Off]  | ●      | –              |    |
|                              | [White Balance]            | <b>[On]</b> , [Off]  | ●      | –              |    |
|                              | <b>C500</b> [Iris]         | <b>[On]</b> , [Off]  | ●      | –              |    |
|                              | [ISO/Gain]                 | <b>[On]</b> , [Off]  | ●      | –              |    |
|                              | [Shutter]                  | <b>[On]</b> , [Off]  | ●      | –              |    |
|                              | [Peaking]                  | <b>[On]</b> , [Off]  | ●      | –              |    |
|                              | [Magnification]            | <b>[On]</b> , [Off]  | ●      | –              |    |
|                              | [View Assist.]             | <b>[On]</b> , [Off]  | ●      | –              |    |
|                              | <b>C500</b> [Lens]         | <b>[On]</b> , [Off]  | ●      | –              |    |
| [Custom Display 2]           | [Remaining Battery]        | [Warning], <b>[Normal]</b> , [Off]                                   | ●      | –              | –  |
|                              | [Remaining Rec Time]       | [Warning], <b>[Normal]</b> , [Off]                                   | ●      | –              |    |
|                              | [Rec Mode]                 | <b>[On]</b> , [Off]  | ●      | –              |    |
|                              | [Genlock]                  | <b>[On]</b> , [Off]  | ●      | –              |    |
|                              | [Time Code]                | <b>[On]</b> , [Off]  | ●      | –              |    |
|                              | [Interval Counter]         | <b>[On]</b> , [Off]  | ●      | –              |    |
|                              | [SD Card Status]           | [Warning], <b>[Normal]</b> , [Off]                                   | ●      | –              |    |
|                              | [Temperature/Fan]          | <b>[On]</b> , [Off]  | ●      | –              |    |
|                              | [4K/2K Mode]               | <b>[On]</b> , [Off]  | ●      | –              |    |
|                              | [Bit Rate]                 | <b>[On]</b> , [Off]  | ●      | –              |    |
|                              | [Resolution]               | <b>[On]</b> , [Off]  | ●      | –              |    |
|                              | [Frame Rate]               | <b>[On]</b> , [Off]  | ●      | –              |    |
|                              | [Character Rec]            | <b>[On]</b> , [Off]  | ●      | –              |    |
|                              | [Output Display]           | [On], <b>[Off]</b>   | ●      | –              |    |
|                              | [Rec Command]              | <b>[On]</b> , [Off]  | ●      | –              |    |
|                              | [User Memo]                | <b>[On]</b> , [Off]  | ●      | –              |    |
|                              | [User Bit]                 | <b>[On]</b> , [Off]  | ●      | –              |    |
|                              | [Audio Output CH]          | <b>[On]</b> , [Off]  | ●      | –              |    |

| Menu item          | Submenu       | Setting options                    | CAMERA | MEDIA          | 📖 |
|--------------------|---------------|------------------------------------|--------|----------------|---|
| [Custom Display 2] | [Audio Level] | [On], [Off]                        | ●      | –              | – |
|                    | [Wi-Fi]       | [On], [Off]                        | ●      | –              |   |
|                    | [Date/Time]   | [Date/Time], [Time], [Date], [Off] | ●      | –              |   |
| [Metadata Display] | [Date/Time]   | [On], [Off]                        | –      | ● <sup>2</sup> | – |
|                    | [Camera Data] | [On], [Off]                        | –      | ● <sup>2</sup> |   |

<sup>1</sup> Setting applies also to the MON. 1 terminal output.

<sup>2</sup> Not available in the [Photos] index screen or photo playback screen.

[Audio Level]: Displays the audio level meter when set to [On].

### [Custom Display 1] settings

[Custom Picture]: Displays the custom picture icon (📷) when set to [On], indicating that a custom picture profile will be recorded with a clip.

📷 [Focal Length]: Displays the current focal length of an attached EF lens when set to [On].

[ND Filter]: Displays the ND filter indicator when set to [On].

[Key Lock]: Displays the key lock icon (🔒) when set to [On].

[White Balance]: Displays the white balance indicator when set to [On].

📷 [Iris]: Displays the aperture setting when set to [On].

[ISO/Gain]: Displays the ISO speed or gain setting when set to [On].

[Shutter]: Displays the shutter speed setting when set to [On].

[Peaking]: Displays the peaking icon (PEAK1 or PEAK2) when set to [On].

[Magnification]: Displays the screen magnification icon (MAGN) when set to [On], indicating that the image on the screen is being magnified.

[View Assist.]: Displays the view assistance icon (VAssist) when set to [On].

📷 [Lens]: Displays the lens warning icon (LENS) when set to [On], indicating that the attached lens cannot communicate with the camera.

### [Custom Display 2] settings

[Remaining Battery]: Controls when the remaining battery indicator appears.

[Warning]: Appears only when there is a warning.

[Normal]: Always appears on the screen.

[Remaining Rec Time]: Displays the remaining recording time.

[Warning]: Appears only when there is a warning.

[Normal]: Always appears on the screen.

[Rec Mode]: Displays the recording operation indicator ([STBY➡] in record pause mode, for example) when set to [On].

[Genlock]: Displays the Genlock synchronization icon (Gen) when set to [On].

[Time Code]: Displays the time code when set to [On].

[Interval Counter]: Displays the countdown during interval recording mode when set to [On].

[SD Card Status]: Controls when the SD card status indicator appears.

[Warning]: Appears only when there is a warning.

[Normal]: Always appears on the screen.

[Temperature/Fan]: Displays the temperature warning icon (🔥) and the cooling fan icon (FAN) when set to [On]. The temperature warning icon indicates that the camera's internal temperature has become high.

[4K/2K Mode]: Displays the recording mode onscreen display for 4K mode ([RAW] or [HRAW]) or 2K mode (RGB444 or YCC422), plus bit depth) when set to [On].

**[Bit Rate]:** Displays the bit rate when set to [On].

**[Resolution]:** Displays the resolution when set to [On].

**[Frame Rate]:** Displays the frame rate when set to [On].

**[Character Rec]:** Displays the character recording warning icon (**CHAR REC**) when set to [On], indicating that the onscreen displays will be recorded on the clip.

**[Output Display]:** Displays the output display warning icon (**DISP**) when set to [On], indicating that the onscreen displays will be output to an external monitor.

**[Rec Command]:** Displays the status of the recording command that is being output when [4K/2K/MXF Setup] **▶** [Rec Command] is set to [On].

**[User Memo]:** Displays the user memo icon (**MEMO**) when set to [On], indicating that a user memo will be recorded with a clip.

**[User Bit]:** Displays the user bit when set to [On].

**[Audio Output CH]:** Displays the audio output channel when set to [On].

**[Audio Level]:** Displays the audio level indicator and, if activated, the audio peak limiter icon (**LM**) when set to [On].

**[Wi-Fi]:** Displays the Wi-Fi icon (**Wi-Fi**) when set to [On].

**[Date/Time]:** Displays the date and/or time.

**[Metadata Display]:** Displays the date and time of recording and/or the camera data (shutter speed, aperture value, gain) during playback of an MXF clip.

#### [00:00 TC/UB Setup] menu (**CAMERA** mode only)

| Menu item   | Submenu               | Setting options           |    |
|-------------|-----------------------|---------------------------|----|
| [Time Code] | [Mode] <sup>1</sup>   | [Preset], [Regen.]        | 84 |
|             | [Run] <sup>1</sup>    | [Rec Run], [Free Run]     | 84 |
|             | [DF/NDF] <sup>2</sup> | [DF], [NDF]               | 85 |
|             | [Setting]             | [Set], [Reset]            | 85 |
|             | [TC In/Out]           | [In], [Out]               | 89 |
|             | [24P TC/Sync]         | [XF Legacy], [Normal]     | –  |
| [User Bit]  | [Rec Mode]            | [Internal], [External]    | 89 |
|             | [Output Mode]         | [Fixed], [Pulldown]       | 91 |
|             | [Type]                | [Setting], [Time], [Date] | 87 |

<sup>1</sup> Available during MXF mode only.

<sup>2</sup> When the frame rate is a setting other than 29.97P, 59.94i or 59.94P, the time code is set to [NDF] and this setting cannot be changed.

**[24P TC/Sync]:** Determines the frequency for time code input and output and synchronization through the GENLOCK terminal and SYNC OUT terminal (tri-level signal) when the frame rate is set to 23.98P or 24.00P.

[XF Legacy]: Synchronization mode compatible with Canon XF series camcorders. Synchronizes the time code at a 30-frame signal and the signal from the GENLOCK terminal and SYNC OUT terminal at a 59.94i or 60.00i signal. The SYNC OUT terminal outputs a 59.94i or 60.00i signal.

[Normal]: Standard synchronization mode. Synchronizes the time code at a 24-frame signal and the signal from the GENLOCK terminal and SYNC OUT terminal at a 23.98P or 24.00P signal. The SYNC OUT terminal outputs a 23.98P/PsF or 24.00P/PsF signal.

#### [00:00 User Bit Setup] menu (**MEDIA** mode only\*)

| Menu item     | Setting options     |    |
|---------------|---------------------|----|
| [Output Mode] | [Fixed], [Pulldown] | 91 |

\* Not available in the [Photos] index screen or photo playback screen.



## [🔍 Other Functions] menu

| Menu item                         | Submenu                         | Setting options  | CAMERA | MEDIA          | 📖   |
|-----------------------------------|---------------------------------|--|--------|----------------|-----|
| [Reset]                           | [All Settings]                  | [Cancel], [OK]   | ●      | ●              | -   |
|                                   | [Camera Settings]               | [Cancel], [OK]   | ●      | -              |     |
|                                   | [Assignable Buttons]            | [Cancel], [OK]   | ●      | ● <sup>1</sup> |     |
| [Transfer Menu/📁]                 | [Save To 📁]                     | [Menu], [Menu+📁]   | ●      | ●              | 124 |
|                                   | [Load From 📁]                   | [Menu], [Menu+📁]   | ●      | ●              |     |
| [Time Zone]                       |                                 | List of world time zones.<br>[UTC-05:00 New York] or [UTC+01:00 Central Europe] <sup>2</sup>       | ●      | ●              | 27  |
| [Set Clock]                       | [Date/Time]                     | -  | ●      | ●              | 27  |
|                                   | [Date Format]                   | [YMD], [YMD/24H], [MDY], [MDY/24H], [DMY], [DMY/24H] <sup>2</sup>                                  | ●      | ●              |     |
| [WFM (LCD)] <sup>1</sup>          | [Setting]                       | [WFM], [VS], [Edge Mon.], [Off]  | ●      | -              | 100 |
|                                   |                                 | [WFM], [VS], [Off]   | -      | ●              |     |
|                                   | [Waveform Monitor]              | [Line], [Line+Spot], [Field], [RGB], [YPbPr]   | ●      | ●              | 100 |
|                                   | [Gain]                          | [1x], [2x]   | ●      | ●              |     |
|                                   | [Vectorscope]                   | [Spot], [Normal]   | ●      | ●              | 101 |
|                                   | [Gain]                          | [1x], [5x]   | ●      | ●              |     |
|                                   | [Edge Monitor]                  | [Type 1], [Type 2]   | ●      | -              | 101 |
| [Gain]                            | [Off], 1 to 15 (12)             | ●  | -      |                |     |
| [Language 🗣️]                     |                                 | [Deutsch], [English], [Español], [Français], [Italiano], [Polski], [Русский], [简体中文], [한국어], [日本語] | ●      | ●              | 28  |
| [Assign Button]                   | [1] to [15]                     | See footnote 3   | ●      | -              | 111 |
|                                   | [1] to [9]                      |  | -      | ● <sup>1</sup> |     |
| [Tally Lamp]                      |                                 | [On], [Off]  | ●      | -              | -   |
| [Media Access LED]                |                                 | [On], [Off]  | ●      | ●              | -   |
| [Fan]                             |                                 | [On], [Automatic]  | ●      | -              | 59  |
| [Genlock Adjust.]                 |                                 | -1023 to +1023 (000)   | ●      | -              | -   |
| [Rec Review]                      |                                 | [Entire Clip], [Last 4 sec]  | ●      | -              | 104 |
| [Delete Last Clip]                |                                 | [Cancel], [OK]   | ●      | -              | -   |
| [Clips] <sup>4</sup>              | [Copy All Clips] <sup>5</sup>   | [Cancel], [OK]   | -      | ●              | 133 |
|                                   | [Copy 📄 Clips] <sup>4</sup>     | [Cancel], [OK]   | -      | ●              | 133 |
|                                   | [Delete All Clips] <sup>5</sup> | [Cancel], [OK]   | -      | ●              | 134 |
| [Delete All 📄 Marks] <sup>4</sup> |                                 | [Cancel], [OK]   | -      | ●              | 133 |
| [Photo Numbering]                 |                                 | [Reset], [Continu.]  | ●      | ● <sup>1</sup> | 167 |
| [Delete All Photos] <sup>6</sup>  |                                 | [Cancel], [OK]   | -      | ●              | 165 |
| [Add 📁 File]                      | [To Clip]                       | [On], [Off]  | ●      | -              | 117 |
|                                   | [To Photo]                      | [On], [Off]  |        |                |     |

| Menu item                   | Submenu               | Setting options  | CAMERA | MEDIA |     |
|-----------------------------|-----------------------|--|--------|-------|-----|
| [Custom Function]           | [Shockless WB]        | [On], <b>[Off]</b>   |        |       | 122 |
|                             | [Control Dial]        | <b>C500</b> [Iris], [ISO/Gain], [Off]<br><b>C500 PL</b> [ISO/Gain], <b>[Off]</b>                 |        |       |     |
|                             | [Grip Ctrl Dial]      | <b>C500</b> [Iris], [ISO/Gain], [Off]<br><b>C500 PL</b> [ISO/Gain], <b>[Off]</b>                 |        |       |     |
|                             | [Control Dial Dir.]   | [Reverse], <b>[Normal]</b>   |        |       |     |
|                             | [Grip Ctrl Dial Dir.] | [Reverse], <b>[Normal]</b>   |        |       |     |
|                             | [SELECT Dial Dir.]    | [Reverse], <b>[Normal]</b>   | ●      | -     |     |
|                             | [F. Assist. B&W]      | [Both], [Magnify], [Peaking], <b>[Off]</b>   |        |       |     |
|                             | [Magn. Add. Disp.]    | [Peaking], [Edge Mon.], <b>[Off]</b>   |        |       |     |
|                             | [3D Rec Mode]         | [On], <b>[Off]</b>   |        |       |     |
|                             | [Scan Reverse Rec]    | [Both], [Vertical], [Horizontal], <b>[Off]</b>   |        |       |     |
|                             | [Character Rec]       | [On], <b>[Off]</b>   |        |       |     |
| [🔒 START/STOP]              | [On], <b>[Off]</b>    |  |        |       |     |
| [Reset Hour Meter]          |                       | <b>[Cancel]</b> , [OK]   | ●      | ●     | -   |
| [Wi-Fi Remote] <sup>7</sup> | [Set Up New]          | For details refer to “WFT-E6 Wireless File Transmitter - Guide for Canon Camcorders” (PDF file). |        |       |     |
|                             | [Select]              |  | ●      | -     | -   |
|                             | [Edit]                |  |        |       |     |
|                             | [Camera Settings]     |  |        |       |     |
|                             | [User Setting]        |  |        |       |     |
| [Initialize Media]          | [CF A]                | <b>[Cancel]</b> , [OK]   | ●      | ●     | 45  |
|                             | [CF B]                |  |        |       |     |
|                             | [SD Card]             | [Complete], [Quick]  | ●      | ●     |     |
| [Firmware]                  |                       | -  | ●      | -     | -   |

<sup>1</sup> Not available in the [Photos] index screen or photo playback screen.

<sup>2</sup> The default value depends on the country/region or purchase.

<sup>3</sup> Setting options for [Assign Button]: [(NONE)], [ND+], [ND-], [PEAKING], [ZEBRA], [WFM], [EDGE MON.], [MAGN.], [Color Bars], [Markers], [LCD Setup], [VF Setup], [LCD/VF B&W], [View Assist.], [LUT], [Resize MON. Output], [Resize MXF Output], [Onscreen Display], [Add Shot Mark 1], [Add Shot Mark 2], [Add Mark], [Add Mark], [Time Code], [Time Code Hold], [Headphone +], [Headphone -], [Audio Output CH], [Audio Level], [Photo], [FUNC.], [FUNC. Shutter], [FUNC. ISO/Gain], [FUNC. WB], [S&F Frame Rate], [My Menu], [Initialize Media], [LENS EXCHANGE], [User Setting (NONE)].

The default settings are as follows. [1]: [MAGN.], [2]: [PEAKING], [3]: [ZEBRA], [4]: [WFM], [5]: [LENS EXCHANGE], [6]: [LUT], [7]: [MAGN.], [8]: [WFM], [9]: [EDGE MON.], [10] to [15]: [(NONE)].

<sup>4</sup> Available in the clip index screen and [ Mark] index screen only.

<sup>5</sup> Available in the clip index screen only.

<sup>6</sup> Available in the [Photos] index screen and photo playback screen only.

<sup>7</sup> Available only when the optional WFT-E6 Wireless File Transmitter is attached to the camera.

**[Reset]:** Reset various camera settings.

[All Settings]: Resets all the camera's settings to default settings, except for the hour meter.

[Camera Settings]: Resets the white balance, iris (**C500** only), ISO speed, gain, shutter speed, [ Camera Setup] settings and custom picture settings to default settings.

[Assignable Buttons]: Resets the assignable buttons to default settings.

**[Tally Lamp]:** Allows you to set whether the tally lamp illuminates while recording.

**[Media Access LED]:** Allows you to set whether the CF card access indicators or the SD card access indicator illuminates while the camera is accessing a CF card or SD card.

**[Genlock Adjust.]:** The phase difference between the external Genlock signal and the camera is initially set to 0. This function allows you to adjust it within the range of approx. ±0.4 H (-1023 to 1023). When setting to 1000 or more or -1000 or less, set the first field to 10 or -10, respectively.

**[Delete Last Clip]:** Deletes the last MXF clip you recorded. This setting option will not appear if you turned the camera off since recording the last clip.

**[Reset Hour Meter]:** The camera has two “hour meters” – the first keeps track of total operation time and the second keeps track of operation time since the last time the second hour meter was reset with this function.

**[Firmware]:** You can verify the current version of the camera’s firmware. This menu option is usually unavailable.

**[★ My Menu]** (CAMERA mode only)

| Menu item | Submenu     | Setting options |    |
|-----------|-------------|-----------------|----|
| [Edit]    | [Register]  | [Cancel], [OK]  | 30 |
|           | [Move]      | [Cancel], [OK]  |    |
|           | [Delete]    | [Cancel], [OK]  |    |
|           | [Reset All] | [Cancel], [OK]  |    |

COPY

## Displaying the Status Screens

You can use the status screens to check the camera's various recording- and playback-related settings. You can also output the status screens on an external monitor.

Operating modes: CAMERA MEDIA | 4K 2K MXF

### 1 Press the STATUS button.

- The status screen most recently displayed will appear unless you turned off the camera or changed the operating mode. In such case, the [Camera] status screen appears in CAMERA mode and the [Assign Button 1/2] status screen appears in MEDIA mode.

### 2 Push the joystick up/down or use the SELECT dial to scroll through the status screens.

### 3 When you are finished, press the STATUS button again to exit the status screens.

- Alternatively, you can press the MENU or CUSTOM PICTURE button. Doing so will exit the status screen and open the respective menu.

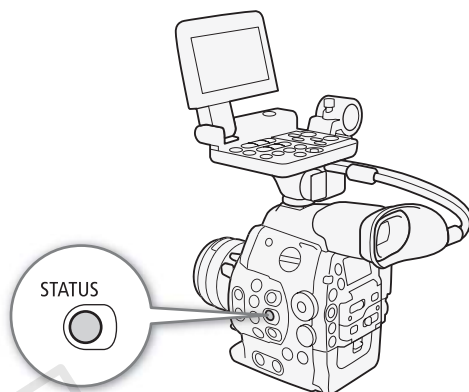

| Status screen  | Description  | CAMERA | MEDIA          | Book icon |
|--|--|--------|----------------|-----------|
| [Gamma/Color Space]                                      | Displays the output settings for each terminal. Also displays the gamma and color space settings of the video on the screen and the video to be recorded on a CF card.   | ●      | —              | 181       |
| [Camera]   | Displays settings related to recording, such as ISO speed/gain, iris <sup>1</sup> and shutter speed increments, peripheral illumination correction <sup>1</sup> and attached lens model information <sup>1</sup> .   | ●      | —              | 181       |
| [Assign Button 1/2], [Assign Button 2/2]                 | Allows you to verify the current function of each assignable button.   | ●      | ●              | 182       |
| [Audio]  | Displays settings related to audio.  | ●      | ● <sup>2</sup> | 182       |
| [Media]  | Displays information about the recording media.  | ●      | ●              | 183       |
| [4K/2K/MXF 1/2], [4K/2K/MXF 2/2]                         | Displays the settings for the video terminals and for MXF clips.   | ●      | —              | 183       |
| [Video]  |  | —      | ●              |           |
| [Metadata 1/2], [Metadata 2/2]                           | Displays the user memo and other metadata that will be recorded with clips.  | ●      | —              | 184       |
| [Battery/Hour Meter]                                     | Allows you to check the remaining battery time, battery life and how long the camera has been in operation.  | ●      | ●              | 185       |
| [CP Data 1/3], [CP Data 2/3], [CP Data 3/3] <sup>3</sup> | Displays the settings for the custom picture file that will be embedded into clips.  | ●      | —              | 185, 186  |
| [Wi-Fi Remote 1/4] to [Wi-Fi Remote 4/4] <sup>4</sup>    | Displays settings related to the configuration of the optional WFT-E6 Wireless File Transmitter and the Wi-Fi network setup. For more details, download the “WFT-E6 Wireless File Transmitter - Guide for Canon Camcorders” (PDF file) from your local Canon Web site and follow the instructions to complete the necessary setup. | ●      | —              | —         |

<sup>1</sup> C500 only.

<sup>2</sup> Does not appear in the [Photos] index screen.

<sup>3</sup> These screens appear only after a custom picture file has been selected.

<sup>4</sup> These screens appear only when the optional WFT-E6 Wireless File Transmitter is attached to the camera and an active access point has been activated with the [Other Functions] [Wi-Fi Remote] setting.

**[Gamma/Color Space] Status Screen** (CAMERA mode only)

| Gamma/Color Space |           | 1/15         |
|-------------------|-----------|--------------|
| Output:           | Gamma:    | Color Space: |
| 1 → 3G-SDI        | Canon Log | BT. 709      |
| 2 → MON. 1        | Canon Log | BT. 709      |
| 3 → MON. 2        | Canon Log | BT. 709      |
| 4 → HD/SD-SDI     | Normal 1  | BT. 709      |
| 5 → SYNC OUT      | Normal 1  | BT. 709      |
| 6 → HDMI&CF Card  | Normal 1  | BT. 709      |
| 7 → LCD/VF        | Normal 1  | BT. 709      |

- 1 3G-SDI terminal (📖 142)
- 2 MON. 1 terminal (📖 142, 146)
- 3 MON. 2 terminal (📖 142, 146)
- 4 HD/SD SDI terminal (📖 58, 117, 146)
- 5 SYNC OUT terminal (📖 58, 117)
- 6 HDMI OUT terminal/CF card recording (📖 58, 117)
- 7 LCD screen/viewfinder\* (📖 58, 117)

\* When using Canon Log gamma and [ LCD/VF Setup] ➤ [View Assist.] is set to [On], [Wide DR] will be displayed in the [Gamma] column.

**[Camera] Status Screen** (CAMERA mode only)

| Camera                          |                  | 2/15 |
|---------------------------------|------------------|------|
| 1 → ISO Increment               | 1/3 stop         |      |
| 2 → Iris Increment              | 1/3 stop         |      |
| 3 → Shutter Increment           | 1/4 stop         |      |
| 4 → Periph. Illum. Corr. Status | Off              |      |
| 5 → Lens Info                   | EF50mm f/1.4 USM |      |

- 1 ISO speed/Gain increment (📖 70)
- 2 **C500** Iris increment (📖 74)
- 3 Shutter speed increment (📖 68)
- 4 **C500** Correction for peripheral illumination (📖 34)
- 5 **C500** Lens model name info (📖 32)

**[Assign Button 1/2], [Assign Button 2/2] Status Screen**

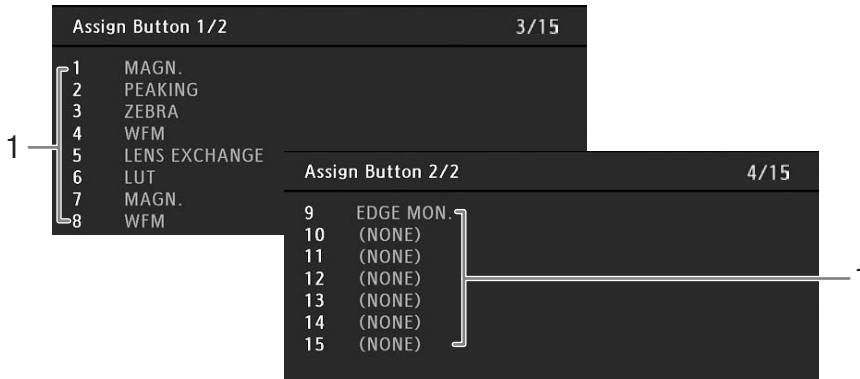

1 Assignable buttons 1 to 15\* (📖 111)

\* Assignable buttons 10 to 15 do not appear in **MEDIA** mode.

**[Audio] Status Screen**

In **CAMERA** mode

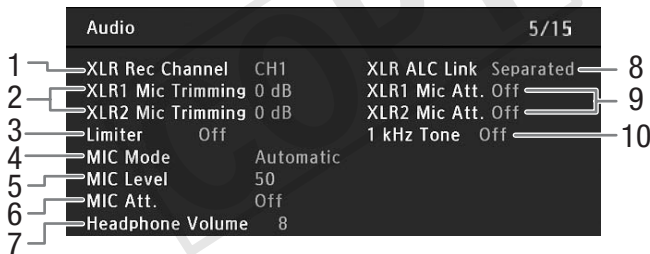

In **MEDIA** mode



- 1 XLR terminal recording channel (📖 93)
- 2 Microphone sensitivity (XLR terminal) (📖 95)
- 3 Audio peak limiter (📖 94, 95)
- 4 Microphone mode (MIC terminal) (📖 95)
- 5 Microphone recording level (MIC terminal) (📖 95)
- 6 Microphone attenuator (MIC terminal) (📖 96)
- 7 Headphone volume (📖 129)
- 8 Linking recording levels of XLR terminals (📖 94)
- 9 Microphone attenuator (XLR terminal) (📖 95)
- 10 Audio reference signal (📖 99)

**[Media] Status Screen**

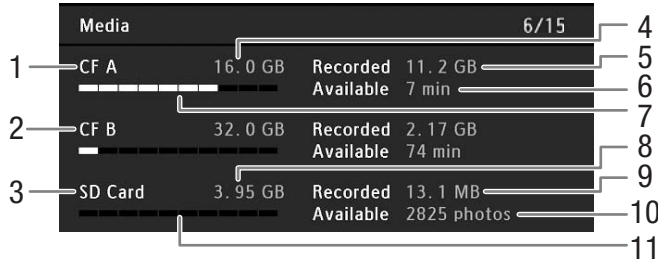

- 1 CF card A
- 2 CF card B
- 3 SD card
- 4 Total space on CF card A
- 5 Used space on CF card A
- 6 Available recording time on CF card A
- 7 Approximate used space on CF card A
- 8 Total space on SD card
- 9 Used space on SD card
- 10 Available number of shots on SD card
- 11 Approximate used space on SD card

**NOTES**

- Depending on the recording media, the total space displayed on the screen may differ from the nominal capacity listed on the CF card or SD card.

**[4K/2K/MXF 1/2] Status Screen** (CAMERA mode, 4K and 2K modes only)

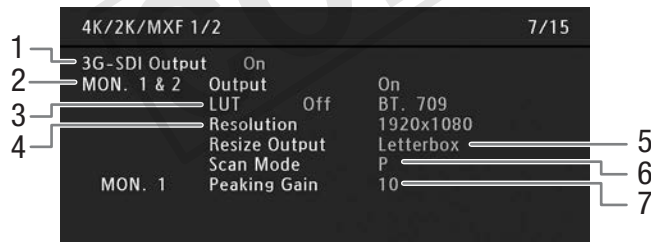

- 1 3G-SDI terminal output status (📖 41)
- 2 MON. terminal output status (📖 145)
- 3 MON. terminal LUT output (📖 146)
- 4 MON. terminal output resolution (📖 145)
- 5 MON. terminal resizing method (📖 145)
- 6 MON. terminal scan mode (📖 145)
- 7 MON. 1 terminal peaking gain (📖 80)

**[4K/2K/MXF 2/2] (CAMERA mode) / [Video] (MEDIA mode) Status Screen**

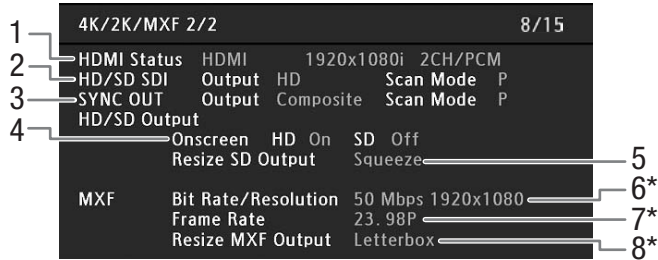

- 1 HDMI OUT terminal status
- 2 HD/SD SDI terminal output status and scan mode (147)
- 3 SYNC OUT terminal output status and scan mode (148)
- 4 HD/SD onscreen displays (149)
- 5 SD output resizing method (148)
- 6 MXF clip bit rate/resolution\* (64)
- 7 MXF clip frame rate\* (65)
- 8 MXF clip resizing method\* (63)

\* Appears in CAMERA mode only.

**[Metadata 1/2] Status Screen (CAMERA mode only)**

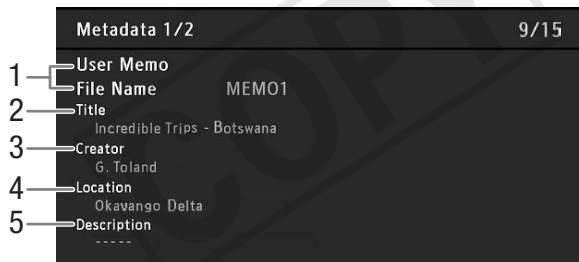

- 1 User memo file name (97)
- 2 Clip title
- 3 Camera operator
- 4 Filming location
- 5 Clip description

**[Metadata 2/2] Status Screen (CAMERA mode only)**

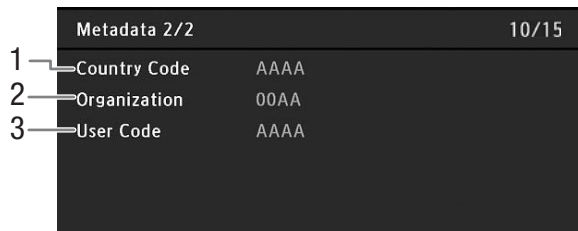

- 1 Country code (172)
- 2 Organization code
- 3 User code



### [Battery/Hour Meter] Status Screen

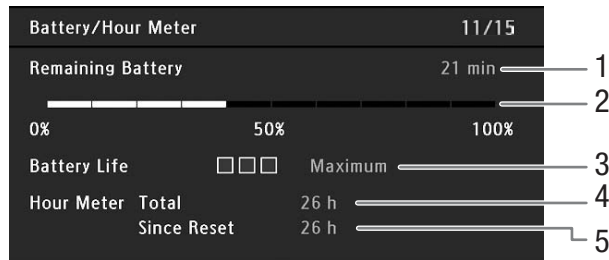

- |                                     |   |
|-------------------------------------|---|
| 1 Remaining recording time          | 4 Total operation time (📖 179)                          |
| 2 Remaining battery level indicator | 5 Operation time since using [Reset Hour Meter] (📖 179) |
| 3 Battery life indicator            |   |

### [CP Data 1/3] Status Screen (CAMERA mode only)

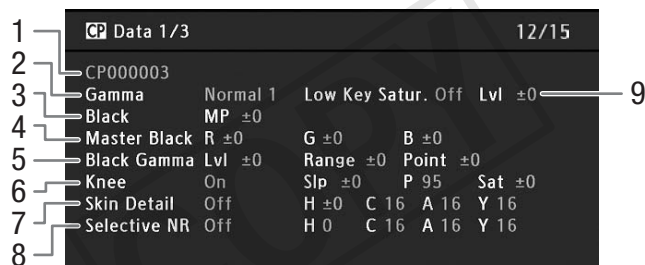

- |   |   |
|---|---|
| 1 Custom picture file name (📖 114)                      | 6 Knee settings (slope, point and saturation) (📖 118)           |
| 2 Gamma (📖 117)   | 7 Skin detail settings (hue, chroma, area and Y level) (📖 120)  |
| 3 Master pedestal (📖 118)                               | 8 Selective NR settings (hue, chroma, area and Y level) (📖 120) |
| 4 Master black RGB levels (📖 118)                       | 9 Low key saturation (📖 118)                                    |
| 5 Black gamma settings (level, range and point) (📖 118) |   |

**[CP Data 2/3] Status Screen (CAMERA mode only)**

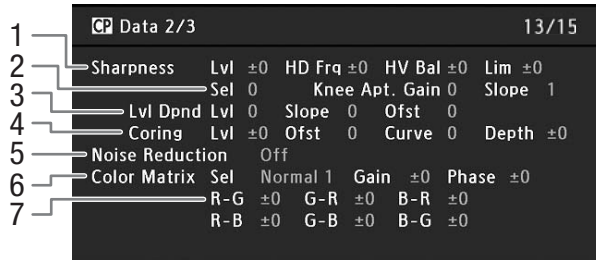

- 1 Sharpness settings (level, horizontal detail frequency, horizontal/vertical detail balance, and limit) (📖 119)
- 2 Sharpness settings (select, knee aperture gain and slope) (📖 119)
- 3 Level depend settings (level, slope and offset) (📖 119)
- 4 Coring settings (level, offset, curve and depth) (📖 119)
- 5 Noise reduction (📖 120)
- 6 Color matrix settings (select, gain and phase) (📖 120)
- 7 Color matrix settings (📖 120)

**[CP Data 3/3] Status Screen (CAMERA mode only)**

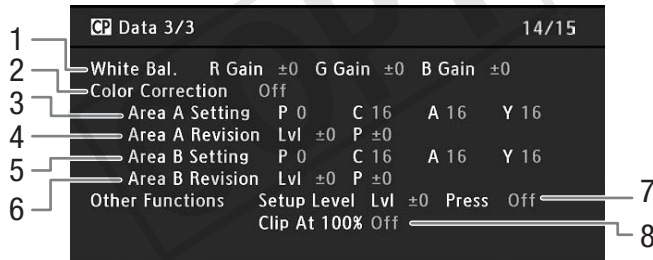

- 1 White balance RGB gain (📖 121)
- 2 Color correction (📖 121)
- 3 Area A settings (phase, chroma, area and Y level) (📖 121)
- 4 Area A revision settings (level and phase) (📖 121)
- 5 Area B settings (phase, chroma, area and Y level) (📖 121)
- 6 Area B revision settings (level and phase) (📖 121)
- 7 Setup level and press (📖 121)
- 8 Clip at 100% (📖 121)

## Troubleshooting

If you have a problem with your camera, refer to this section. Consult a Canon Service Center if the problem persists.

### Power source

#### The camera will not turn on or it turns off by itself.

- The battery pack is exhausted. Replace or charge the battery pack.
- Remove the battery pack and reattach it correctly.

#### Shortly after turning it on, the camera turns off on its own.

- You are using a DC coupler or a battery pack that is not compatible for use with this camera. Use a recommended battery pack (□ 201).

#### Cannot charge the battery pack.

- The temperature of the battery pack is outside the charging range. If the battery pack's temperature is below 0 °C (32 °F), warm it before charging it; if it is above 40 °C (104 °F), let the battery pack cool down before charging it.
- Charge the battery pack in temperatures between 0 °C and 40 °C (32 °F and 104 °F).
- The battery pack is faulty. Replace the battery pack.

#### The battery pack is exhausted extremely quickly even at normal temperatures.

- Check the [Battery/Hour Meter] status screen (□ 185) to see whether the battery pack is at the end of its service life. If so, buy a new battery pack.

### Recording

#### The camera's controls are not responsive/disabled

- The plug being connected into the GRIP terminal may not be correctly connected. Make sure the plug is firmly inserted all the way into the GRIP terminal.
- When the **POWER** switch is set to **Ⓐ**, all buttons except for the START/STOP button are locked\* and cannot be operated. Set the **POWER** switch to CAMERA.
- \* If the [Other Functions] ➤ [Custom Function] ➤ [START/STOP] setting is on, the START/STOP button will also be locked.

#### Pressing the START/STOP button will not start recording.

- Set [4K/2K/MXF Setup] ➤ [3GI-SDI Output] to [On] to enable output from the 3G-SDI or MON. terminals.
- Set [4K/2K/MXF Setup] ➤ [Rec Command] to [On] to enable the external recorder to be operated using the camera's START/STOP button.
- The camera is in lens exchange mode. Press the LENS EXCHANGE button to exit the mode.

#### The point where the START/STOP button was pressed does not match the beginning/end of the recording.

- There is a slight interval between pressing the START/STOP button and the actual start/end of recording. This is not a malfunction.

#### The camera will not focus.

- The viewfinder is not adjusted. Use the dioptic adjustment dial to make the proper adjustment (□ 36).
- The lens is dirty. Clean the lens with a soft lens-cleaning cloth.

#### When a subject flits across in front of the lens, the image appears slightly bent.

- This is a phenomenon typical of CMOS image sensors. When a subject crosses very quickly in front of the camera, the image may seem slightly warped. This is not a malfunction.

#### Bright red, green or blue dots appear on the screen.

- The camera's CMOS sensor is a delicate piece of precision engineering. Direct exposure of the sensor to ion rays or other types of cosmic radiation may affect it and this may rarely appear as bright colored dots on the screen. This is the nature of CMOS image sensors and does not represent a malfunction. Adjusting the black balance (□ 48) may help solve the problem.
- The effects of the damage may be more noticeable when the camera is used in places subject to high temperatures, when a high ISO speed or gain level is used and when slow shutter speeds are used.

#### Changing between recording (●REC) and record pause (STBY) takes longer than usual.

- When the CF card contains a large number of clips, some operations may take longer than usual. Save your clips (□ 153) and initialize the CF card (□ 45). Alternatively, replace the CF card.

#### The camera cannot record to a CF card properly.

- This may occur as recordings are made and deleted over time. Save your clips (□ 153) and initialize the CF card (□ 45).

**The camera becomes hot during use.**

- The camera may become hot while shooting. This is not a malfunction.
- The camera's internal temperature will rise if the cooling fan filter under the MON./3G-SDI terminal cover has clogged. Replace the filter (☐ 198).

**The built-in ND filter is stuck and does not change.**

- The electronic motor that drives the ND filter may not be working correctly. As an emergency measure, you can operate the ND filter manually (☐ 199). Eventually, consult a Canon Service Center.

## Playing Back MXF Clips

**Cannot delete a clip.**

- You cannot delete clips with an **OK** mark. Remove the **OK** mark (☐ 132) to delete the clip.

**Deleting clips takes longer than usual.**

- When the CF card contains a large number of clips, some operations may take longer than usual. Save your clips (☐ 153) and initialize the CF card (☐ 45).

**Cannot delete a photo.**

- The photo is protected. Remove the protection (☐ 165).
- The LOCK switch on the SD card is set to prevent accidental erasure. Change the position of the LOCK switch.

**Cannot copy clips.**

- There is not enough available space on the CF card being copied to or the CF card already contains the maximum number of clips (999 clips). Delete some clips (☐ 134) to free some space or replace the CF card.

## Indicators and Onscreen Displays

** appears in red on the screen.**

- Battery pack is exhausted. Replace or charge the battery pack.

** appears on the screen.**

- The camera cannot communicate with the battery pack attached so the remaining battery time cannot be displayed.

**The tally lamp does not illuminate.**

- Set [Other Functions] **▶** [Tally Lamp] to [On].

**The tally lamp flashes quickly.  (4 flashes per second)**

- The battery pack is exhausted. Replace or charge the battery pack.
- There is not enough available space on the CF card. Delete some clips (☐ 134) to free some space or replace the CF card.
- A system error has occurred. Turn off the camera and back on again. If this does not solve the problem, consult a Canon Service Center.

**The tally lamp flashes slowly.  (1 flash per second)**

- The combined available space on both CF cards is low. Replace the CF card that is not being recorded onto.

****A** or **B** appears in red on the screen.**

- There is not enough available space on the CF card. Delete some clips (☐ 134) to free some space or replace the CF card.

** appears in red on the screen.**

- An SD card error occurred. Turn off the camera. Remove and reinsert the SD card. Initialize the SD card if the display does not change back to normal.
- The SD card is full. Replace the SD card or delete some photos (☐ 164) to free some space on the SD card.

**Even after stopping recording, the CF **A**/CF **B** access indicator stays illuminated in red.**

- The clip is being recorded. This is not a malfunction.

** appears in yellow on the screen.**

- The camera's internal temperature has reached a predetermined level. You can continue using the camera.

**TEMP** appears in red on the screen.

- The camera's internal temperature has risen while **TEMP** appeared in yellow on the screen.
- If [Other Functions] ➤ [Fan] is set to [On], turn off the camera and wait until the temperature has lowered.
- In [CAMERA] mode, when [Other Functions] ➤ [Fan] is set to [Automatic] and the cooling fan is deactivated while you are shooting, the cooling fan will start automatically (**FAN** appears on the screen).
- The camera's internal temperature will rise if the cooling fan filter under the MON./3G-SDI terminal cover has clogged. Replace the filter (☐ 198).

**LENS** appears on the screen.

- The camera and lens cannot communicate normally.

## Picture and Sound

### Screen displays turn on and off repeatedly.

- The battery pack is exhausted. Replace or charge the battery pack.
- Remove the battery pack and reattach it correctly.

### Abnormal characters appear on the screen and the camera does not operate properly.

- Disconnect the power source and reconnect it after a short time. If the problem still persists, perform one of the following actions.
  - Disconnect the power source and press the RESET button. This resets all the camera's settings to default values except for custom picture settings and the hour meter.
  - Use the [Other Functions] ➤ [Reset] ➤ [All Settings] function. This resets all the camera's settings to default values except for the hour meter.

### Video noise appears on screen.

- Keep a distance between the camera and devices that emit strong electromagnetic fields such as near powerful magnets and motors, MRI machines or high-voltage power lines.

### Horizontal bands appear on the screen.

- This is a phenomenon typical of CMOS image sensors when recording under some types of fluorescent, mercury or sodium lamps. This is not a malfunction. You may be able to reduce the symptoms by setting the shutter mode to [Speed] and the shutter speed to a value matching the frequency of the local electrical system: 1/50\* or 1/100 for 50 Hz systems, 1/60 or 1/120 for 60 Hz systems.
  - \* May not be available depending on the frame rate.

### Audio cannot be recorded.

- An external microphone connected to the XLR terminal requires phantom power. Set the XLR terminal switch to MIC+48V (☐ 93).
- The camera's MIC terminal is given priority over the XLR terminals. To record audio from the XLR terminals, be sure not to connect any microphones to the MIC terminal.

### Audio is recorded at an extremely low level.

- When using the XLR terminals: The AUDIO LEVEL switch is set to M, and the recording level is set too low. When using the MIC terminal: [Audio Setup] ➤ [Audio Input] ➤ [MIC Mode] is set to [Manual] and the [MIC Level] setting is too low. Check the audio level meter on the screen or rear panel and adjust the audio level correctly (☐ 94, 95).
- The microphone attenuator is on. Turn off the microphone attenuator (☐ 95, 96).

### Sound is distorted or is recorded at lower levels.

- When recording near loud sounds (such as fireworks, shows or concerts), sound may become distorted or it may not be recorded at the actual levels. Activate the microphone attenuator (☐ 95, 96), or adjust the audio recording level manually.

## Recording Media and Accessories

### Cannot insert the recording media.

- The CF card or SD card you are trying to insert is not facing the correct direction. Turn it over and insert it.

### Cannot record on the CF card.

- A compatible CF card must be used (☐ 43).
- Initialize the CF card (☐ 45) when you use it with the camera for the first time.
- The CF card is full or it already contains the maximum number of clips (999 clips). Delete some clips (☐ 134) to free some space or replace the CF card.

**Cannot record on the SD card.**

- Initialize the SD card (☞ 45) when you use it with the camera for the first time.
- The LOCK switch on the SD card is set to prevent accidental erasure. Change the position of the LOCK switch.
- The SD card is full. Delete some photos (☞ 164) to free some space or replace the SD card.
- The folder and file numbers have reached their maximum value. Set the [Other Functions] ► [Photo Numbering] setting to [Reset] and insert a new SD card.

**Recording to and playing back from a CF card is slow.**

- This may occur as video is recorded/deleted over time. Save your clips (☞ 153) and initialize the CF card (☞ 45).

**Recording to and playing back from an SD card is slow.**

- This may occur as photos are recorded/deleted over time. Save your photos and initialize the SD card (☞ 45).

## Connections with External Devices

**Video is not recorded on an external recorder.**

- Make sure the camera is connected to the external recorder correctly (☞ 41).
- Check the external recorder's instruction manual to make sure that the external recorder is set to receive the signal being output by the camera.

**Video noise appears on a nearby TV screen.**

- When using the camera in a room where a TV is located, keep a distance between the compact power adapter and the power or antenna cables of the TV.

**Playback looks fine on the camera but there is no image on the external monitor.**

- The camera is not connected correctly to the external monitor. Make sure you are using the correct connection (☞ 144).
- The video input on the external monitor is not set to the video terminal to which you connected the camera. Select the correct video input.

**The camera is connected using a commercially available HDMI cable, but there is no picture or sound from the external monitor.**

- Disconnect the HDMI cable and then restore the connection or turn the camera off and then on again.

## List of Messages

Refer to this section if a message appears on the screen. The messages in this section appear in alphabetical order. For error messages related to the optional WFT-E6 Wireless File Transmitter refer to the *Troubleshooting* section of the 'WFT-E6 Wireless File Transmitter - Guide for Canon Camcorders' (☞ 34).

**Accessing CF A/CF B Do not remove**

- You opened the CF card slot cover while the camera was accessing the CF card. Close the CF card slot cover.

**Camera ↔ Lens communication error. Clean the lens's contacts and reattach the lens.**

- The camera cannot communicate with the lens. Remove the lens while making sure that dust does not accumulate on the lens or enter the camera. Then, wipe the lens mount and lens contacts with a soft cloth.

**Cannot acquire battery information**

- Battery information can be displayed only for batteries bearing the Intelligent System mark.

**Cannot communicate with the battery pack. Continue using this battery pack?**

- You attached a battery pack that does not bear the Intelligent System mark.
- If you are using a battery pack that bears the Intelligent System mark, there may be a problem with the camera or battery pack. Consult a Canon Service Center.

**Cannot play back**

- The file control information is corrupted or there was a decoder error. Turn off the camera and back on again. If this does not solve the problem, consult a Canon Service Center.
  - Corrupted file control information cannot be recovered. CF cards or clips with corrupt file control information cannot be read by the supplied Canon XF Utility or plugins.

**Cannot record**

- Cannot record on a CF card. The file control information is corrupted or there was an encoder error. Turn off the camera and back on again. Then, remove the CF card being used and reinsert it. Alternatively, replace the CF card. If this does not solve the problem, consult a Canon Service Center.
  - Corrupted file control information cannot be recovered. CF cards or clips with corrupt file control information cannot be read by the supplied Canon XF Utility or plugins.

**Cannot switch CF card slots**

- The SLOT SELECT button was pressed while the camera is recording. Wait until recording is finished to change the selected CF card slot.

**CF A/CF B Buffer overflow. Recording was stopped.**

- The data transfer rate was too high for the CF card in use and the recording was stopped. Use a recommended card (□ 43).

**CF A/CF B Cannot restore**

- Could not recover data on the CF card. Save your clips (□ 153) and initialize the CF card (□ 45).

**CF A/CF B error**

- The CF card cannot be recognized or cannot be accessed. Check that the CF card is inserted correctly and not malfunctioning.

**CF A/CF B Management data is not supported and will be deleted**

- This message may appear if you insert into the camera a CF card that was initialized by a Canon professional camcorder. Check the contents of the CF card.

**CF A/CF B Management file error Cannot record**

- Cannot record because the camera cannot write to the file control information. This may occur if the files on the CF card were accessed using another device. Save your clips (□ 153) and initialize the CF card (□ 45).
  - During double slot recording, both "CF A" and "CF B" will appear in the message.

**CF A/CF B Media full**

- If either "CF A" or "CF B" appears in the message: CF card A or CF card B is full so recording will not start. Switch to the CF card in the other CF card slot to record.
- If both "CF A" and "CF B" appear in the message: CF card A and CF card B are full. Delete some clips (□ 134) to free some space or replace a CF card.

**CF A/CF B Media is almost full**

- The amount of available space on CF card A and CF card B combined is low. Replace the CF card that is not selected.

**CF A/CF B Media is not supported**

- CF cards that are less than 512 MB or not UDMA-compatible cannot be used with the camera. Use a recommended CF card (□ 43).

**CF A/CF B Number of clips already at maximum**

- The CF card selected for recording already contains the maximum number of clips (999 clips). Replace the CF card or use the CF card in the other CF card slot.
- Because both CF cards reached the maximum number of clips, double slot recording is not available.
  - During double slot recording, both "CF A" and "CF B" will appear in the message.

**CF A/CF B Operation canceled.**

- The file control information is corrupted or there was an encoder error. Turn off the camera and back on again. Then, remove the CF card being used and reinsert it. Alternatively, replace the CF card. If this does not solve the problem, consult a Canon Service Center.
  - Corrupted file control information cannot be recovered. CF cards or clips with corrupt file control information cannot be read by the supplied Canon XF Utility or plugins.

**CF A/CF B Reached the recording limit for one clip. Recording was stopped.**

- When recording a single clip for an extended period of time, the clip will be split into smaller video files every 2 GB (or 1 GB when recording in slow motion). This message will appear when the number of smaller video files reaches 99.

**CF A/CF B Using a card that supports UDMA mode 4 or higher is recommended**

- The CF card's UDMA mode is lower than UDMA4. We recommend using a CF card that with a UDMA mode of at least UDMA4.

**CF A→CF B / CF B→CF A Switched**

- This message appears when you use the SLOT SELECT button to switch the CF card slot in use or recording continued from one CF card to the other.

**CF A→CF B / CF B→CF A Will switch in a moment**

- The CF card is almost full so recording will continue on the other CF card in approximately 1 minute.

**CF card slot cover is open.**

- The CF card slot cover was open when the camera was switched to or turned on in **CAMERA** mode. Close the cover.

**Change the battery pack**

- The battery pack is exhausted. Replace or charge the battery pack.

**✓ / OK Mark Error**

- Could not add a **✓** mark or **OK** mark. If the message appears in **CAMERA** mode, try adding the mark again. If that does not work, add the mark in **MEDIA** mode. If the message appears in **MEDIA** mode, turn off the camera and then back on. Then, try to add the mark again.

**Check the data on CF A/CF B Initializing the card is also recommended**

- The CF card cannot be used for any of the following reasons.
  - A problem has occurred with the CF card.
  - The camera cannot read the CF card's data.
  - The CF card was initialized using a computer.
  - The CF card has been partitioned.
- Save your clips (☐ 153) and initialize the CF card (☐ 45).

**Check the SD card**

- The SD card cannot be accessed. Check that the SD card is inserted correctly and not malfunctioning.
- Due to an SD card error, photos cannot be taken or viewed. Remove and then reinsert the SD card or use a different SD card.

**Data on CF A/CF B needs recovering Attempt to recover?**

- If data on the CF card is corrupted, such as when the power suddenly turned off while recording, the data must be recovered. When this message appears, select [OK] and press SET.

**Fan error**

- The cooling fan may not be working properly. Consult a Canon Service Center.

**File name error**

- The folder and file numbers have reached their maximum value. Set [Other Functions] ➤ [Photo Numbering] to [Reset] and delete all the photos on the SD card (☐ 164) or initialize it (☐ 45).

**Invalid operation**

- The following operations cannot be performed.
  - Adding a shot mark to a clip that already has a shot mark or to a clip in frame recording mode or interval recording mode.
  - Adding an **OK** mark to clip that already has an **OK** mark or adding a **✓** mark to a clip that already has a **✓** mark.
  - In **CAMERA** mode, immediately reviewing a recording made in a special recording mode.
  - Pressing the START/STOP button when there is no CF card in the camera during MXF mode.

**No clips**

- There are no clips on the CF card to play back. Clips must be recorded (☐ 51) in order to play them back.

**No photos**

- There are no photos on the SD card to play back. Photos must be taken (☐ 161) in order to view them.

**No Shot Marks**

- This message appears if shot marks in a clip were deleted from the [Shot Mark] index screen. Press the INDEX button to return to the clip index screen.

**Number of Shot Marks at maximum**

- The shot mark could not be added because the clip already contains 100 shot marks (S1 and S2 marks combined). You must delete shot marks (☐ 137) before adding any more.

**Please open the MON./3G-SDI terminal cover**

- The camera cannot enter 4K or 2K mode when the MON./3G-SDI terminal cover is closed. Open the cover.

**Recorded at 24.00 Hz Check the data on CF A/CF B Initializing the card is also recommended.**

- The CF card contains 24.00 Hz recordings. To record on this CF card, save your clips (☐ 153) and initialize the CF card (☐ 45). To play back the recordings on the CF card, set [4K/2K/MXF Setup] ➤ [System Frequency] to [24.00 Hz].

**Recorded at 59.94 Hz/50.00 Hz Check the data on CF A/CF B Initializing the card is also recommended**

- The CF card contains clips that were recorded using a system frequency other than the one currently used by the camera. To record on this CF card, save your clips (☐ 153) and initialize the CF card (☐ 45). To play back the recordings on the CF card, set [4K/2K/MXF Setup] ➤ [System Frequency] to [59.94 Hz] or [50.00 Hz] as necessary, so the camera matches the CF card.

**SD card error**

- You inserted a MultiMedia Card (MMC) into the camera. Use a recommended SD card (☐ 43).



**Shot Mark Error**

- Could not add a shot mark. If the message appears in **CAMERA** mode, try adding the mark again. If that does not work, add the mark in **MEDIA** mode after you finish recording. If the message appears in **MEDIA** mode, turn off the camera and then back on. Then, try to add the mark again.

**System error**

- Turn off the camera and back on again. If this does not solve the problem, there may be a malfunction with the camera. Consult a Canon Service Center.

**This photo cannot be displayed**

- You may not be able to display photos taken with other devices or image files created or edited on a computer.



## Handling Precautions

### Camera

Be sure to observe the following precautions to ensure maximum performance.

- Do not carry the camera by the LCD panel or monitor unit. Be careful when closing the LCD panel.
- Do not leave the camera in places subject to high temperatures (like the inside of a car parked under direct sunlight), or high humidity.
- Because the camera's temperature can rise significantly, do not hold the camera for long periods of time while shooting.
- Do not use the camera near strong electromagnetic fields such as near powerful magnets and motors, MRI machines or high-voltage power lines. Using the camera in such places may cause anomalies in the video or audio or video noise to appear.
- Do not use or store the camera in dusty or sandy places. The camera is not waterproof – avoid also water, mud or salt. If any of the above should get into the camera it may damage the camera and/or the lens. Consult a Canon Service Center as soon as possible.
- Be careful to avoid dust and dirt particles accumulating on the lens or entering the camera. When you finish using the camera, make sure to attach the body cap to the lens mount and the lens cap and dust cap to the lens.
- Do not point the lens or viewfinder lens at the sun or other strong light sources. Do not leave the camera pointed at a bright subject. Internal components may become damaged due to concentration of the light by the lens. Be careful especially when using a tripod or shoulder strap. When you are not using the camera or viewfinder, make sure to attach the lens cap to the lens and the viewfinder cap to the viewfinder.
- Be careful of heat generated by lighting equipment.
- Do not disassemble the camera. If the camera does not function properly, consult qualified service personnel.
- Do not touch the lens contacts on the lens mount. Dirty contacts may cause a poor contact between the camera and the lens resulting in incorrect operation of the camera. After removing the lens, make sure to attach the body cap to the lens mount and the lens cap and dust cap to the lens.
- Handle the camera with care. Do not subject the camera to shocks or vibration as this may cause damage. When using the shoulder strap, do not allow the camera to swing and hit an object.



### Long-term storage

If you do not intend to use the camera for a long time, store it in a place free of dust, in low humidity, and at temperatures not higher than 30 °C (86 °F).

### Battery Pack

#### **DANGER!**

Treat the battery pack with care.

- Keep it away from fire (or it might explode).
  - Do not expose the battery pack to temperature higher than 60 °C (140 °F). Do not leave it near a heater or inside a car in hot weather.
  - Do not try to disassemble or modify it.
  - Do not drop it or subject it to shocks.
  - Do not get it wet.
- Dirty terminals may cause a poor contact between the battery pack and the camera. Wipe the terminals with a soft cloth.

### Long-term storage

- Store battery packs in a dry place at temperatures no higher than 30 °C (86 °F).
- To extend the battery life of the battery pack, discharge it completely before storing it.
- Charge and discharge all your battery packs fully at least once a year.

### Always attach the battery terminal cover.

Do not allow any metal objects to touch the terminals (figure 1), as this can cause a short circuit and damage the battery pack. Attach the terminal cover whenever the battery pack is not being used (figure 2).

The battery terminal cover has a [ ]-shaped hole. This is useful when you wish to differentiate between charged and uncharged battery packs. For example, with charged battery packs, attach the terminal cover so that the [ ]-shaped hole shows the colored label.

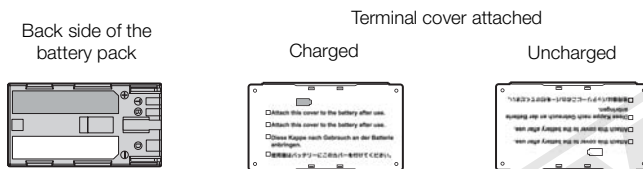
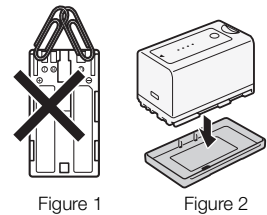

### Remaining battery time

If the remaining battery time displayed is not correct, charge the battery pack fully. Still, the correct time may not be displayed if a fully charged battery pack is used continuously in high temperatures or it is left unused for long periods of time. Also, the correct remaining time may not be displayed, depending on the battery life. Use the time shown on the screen as an approximation.

### Using higher capacity batteries

You can use the optional BP-970G / BP-975 battery packs with this camera. However, as the battery compartment cover cannot be closed when using these higher capacity battery packs, you will need to remove it beforehand. Note that removing the battery compartment cover will render the camera more exposed to moisture, dust and foreign objects.

- 1 Slide down the BATT.OPEN switch and open the battery compartment cover.
- 2 Push the latch at the bottom of battery compartment.
- 3 Gently pull out the battery compartment cover.

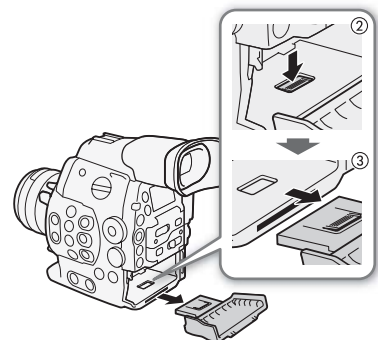

### Regarding the use of non-Canon battery packs

- We recommend using genuine Canon battery packs bearing the Intelligent System mark.
- If you attach to the camera battery packs that are not genuine Canon battery packs, the remaining battery time will not be displayed.

### ! IMPORTANT

- To prevent equipment breakdown, do not connect the battery charger to voltage converters.

## Recording Media

- We recommend backing up the recordings on the recording media onto your computer. Data may be corrupted or lost due to defects or exposure to static electricity. Canon shall not be liable for lost or corrupted data.
- Do not touch or expose the terminals to dust or dirt.
- Do not use recording media in places subject to strong magnetic fields.
- Do not leave recording media in places subject to high humidity and high temperature.
- Do not disassemble, bend, drop, or subject recording media to shocks and do not expose them to water.
- Check the direction before inserting the recording media. Forcing recording media into the slot if it is not correctly oriented may damage the recording media or the camera.
- Do not attach any labels or stickers on the recording media.
- **SD cards:** SD cards have a physical switch to prevent writing on the card so as to avoid the accidental erasure of the card's content. To write-protect the SD card, set the switch to the LOCK position.

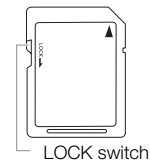

## Disposal

When you delete data on the recording media, only the file allocation table is altered and stored data is not physically erased. Take the necessary precautions when you dispose of the recording media, for example by physically damaging it to prevent the leakage of private data.

If giving the recording media to another person, initialize it (using the [Complete] initialization option for SD cards, (☞ 45)). Fill it up with unimportant recordings, and then initialize it again. This makes recovering the original recordings very difficult.

## Built-in Rechargeable Lithium Battery

The camera has a built-in rechargeable lithium battery to keep the date/time and other settings. The built-in lithium battery is recharged while you use the camera; however, it will discharge completely if you do not use the camera for about 3 months.

**To recharge the built-in lithium battery:** Connect the compact power adapter to the camera and use a household power outlet to power the camera for 24 hours while it is turned off.

## Maintenance/Others

### Cleaning

#### Camera Body

- Use a soft, dry cloth to clean the camera body. Never use chemically treated cloths or volatile solvents such as paint thinner.

#### Lens

- Remove any dust or dirt particles using a non-aerosol type blower brush.
- Use a clean, soft lens-cleaning cloth to gently wipe the lens using commercially available cleaning fluid for eyeglasses. Never use tissue paper.

#### LCD Screen

- Clean the LCD screen using a clean, soft lens-cleaning cloth.
- Condensation may form on the surface of the screen when the temperature changes suddenly. Wipe it with a soft dry cloth.

#### Viewfinder

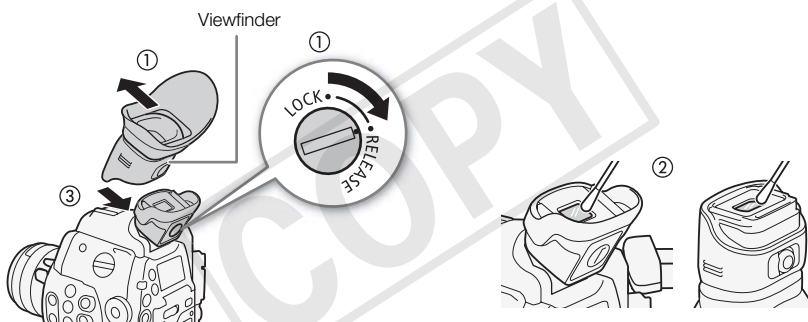

- 1 Slide the viewfinder unit's LOCK/RELEASE screw to the RELEASE position and remove the viewfinder unit by sliding it up.
- 2 Wipe away dirt with a cotton swab.
- 3 Reattach the viewfinder unit by sliding it back onto the camera and turn back the LOCK/RELEASE screw to the LOCK position.

#### ! IMPORTANT

- Be careful not to scratch the glass and screen when cleaning them.

## Replacing the Cooling Fan Filter

You can replace the cooling fan filter, which is located under the cover of the MON./3G-SDI terminals.

### 1 Remove the cooling fan cover.

- Hold the top and bottom of the center opening and remove the cover.

### 2 Remove the filter.

### 3 Attach the new filter.

### 4 Reattach the cover.

- Hook the cover behind the lower tabs as shown in the illustration and then hook the cover behind the upper tabs.

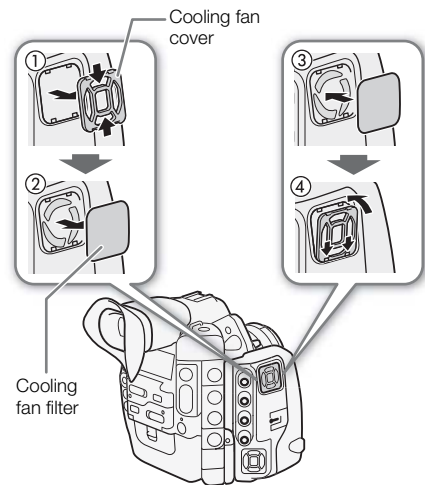

### **i** NOTES

- Filters can be reused by washing them in water or mild detergent. Make sure filters are completely dry before attaching them to the camera.
- Contact a Canon Service Center to purchase replacement filters.

## Condensation

Moving the camera rapidly between hot and cold temperatures may cause condensation (water droplets) to form on its internal surfaces. Stop using the camera if condensation is detected. Continued use may damage the camera.

### Condensation may form in the following cases:

- When the camera is moved quickly from cold to warm places
- When the camera is left in a humid room
- When a cold room is heated rapidly

### To avoid condensation

- Do not expose the camera to sudden or extreme changes in temperature.
- Remove the recording media and battery pack. Then, place the camera in an airtight plastic bag and let it adjust gradually to temperature changes before removing it from the bag.

### When condensation is detected

The precise time required for water droplets to evaporate will vary depending on the location and weather conditions. As a general rule, wait for 2 hours before resuming use of the camera.

## Operating the ND Filter Manually

In the rare case that the internal electronic motor that drives the ND filter malfunctions, you can operate the ND filter manually as an emergency measure.

- 1 Turn off the camera and remove the lens.
- 2 Unscrew the screw in the illustration and remove the cover.
- 3 Pressing lightly, use a Phillips head screwdriver to turn the ND filter as necessary.
  - You can check the position of the ND filter through the lens mount.
- 4 Return the cover and tighten the screw.

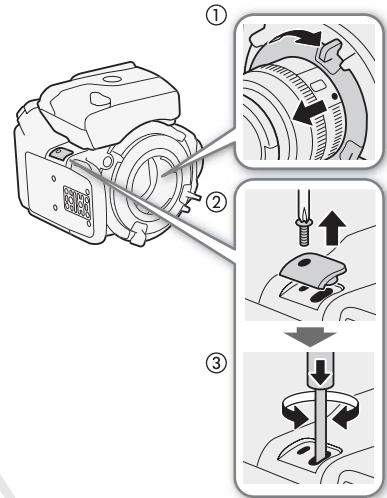

## Using the Camera Abroad

### Power Sources

You can use the compact power adapter to operate the camera and to charge battery packs in any country with power supply between 100 and 240 V AC, 50/60 Hz. Consult a Canon Service Center for information on plug adapters for overseas use.

COPY

## Optional Accessories

The following optional accessories are compatible with this camera. The availability differs from area to area.

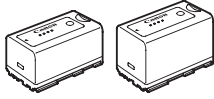

BP-950G, BP-955,  
BP-970G, BP-975  
Battery Pack

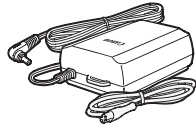

CA-941 Compact  
Power Adapter

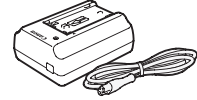

CA-930 Compact  
Power Adapter\*

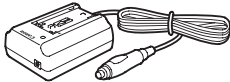

CB-920 Car Battery  
Adapter\*

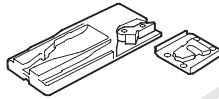

TA-100 Tripod Adapter



TB-1 Tripod Adapter  
Base\*\*

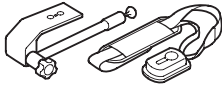

SBR-1000 Shooting  
Brace



WFT-E6 Wireless File  
Transmitter

\* This accessory cannot be used to power this camera directly; it can only be used to charge the battery pack.

\*\*For tripods with 0.95 cm (3/8 in.) screws.

### Use of genuine Canon accessories is recommended.

This product is designed to achieve excellent performance when used with genuine Canon accessories. Canon shall not be liable for any damage to this product and/or accidents such as fire, etc., caused by the malfunction of non-genuine Canon accessories (e.g., a leakage and/or explosion of a battery pack). Please note that this warranty does not apply to repairs arising out of the malfunction of non-genuine Canon accessories, although you may request such repairs on a chargeable basis.



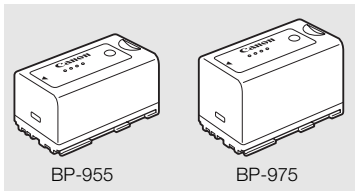

### Battery Packs

When you need extra battery packs, select from the following: BP-950G, BP-955, BP-970G\*, BP-975\*

When you use battery packs bearing the Intelligent System mark, the camera will communicate with the battery and display the remaining usage time (accurate to 1 minute). You can only use and charge these battery packs with cameras and chargers compatible with Intelligent System.

\* The optional BP-970G / BP-975 Battery Pack were not originally designed for use with this camera. Because of its size, you will not be able to close the battery compartment cover when using one (☐ 195).

### Charging Times

Use the supplied CG-940 Battery Charger to charge battery packs. The charging times given in the following table are approximate and vary according to charging conditions and initial charge of the battery pack.

| BP-950G  | BP-955   | BP-970G  | BP-975   |
|----------|----------|----------|----------|
| 245 min. | 200 min. | 350 min. | 295 min. |

### Recording and Playback Times

Recording and playback times given in the following tables are approximate and vary according to recording mode and charging, recording or playback conditions. The effective usage time of the battery pack may decrease when recording in cold surroundings, when using the brighter screen settings, etc. The typical shooting times listed below are approximate times for shooting with repeated operations such as start/stop, and power on/off.

**C500** EF lenses with lens contacts draw power from the camera to operate some functions. Effective usage times may decrease depending on the lens used.

Other accessories attached to the camcorder, such as the optional WFT-E6 Wireless File Transmitter, also draw power from the camcorder to operate. Effective usage times will decrease when such accessories are used while shooting.

### Approximate times when shooting in 4K mode

The following are the shooting times with the monitor unit attached (LCD screen and viewfinder on), output from the 3G-SDI terminals, MON. terminals and HD/SD SDI terminal on, and when simultaneously recording an MXF clip (50 Mbps, 1920x1080, 23.98P).

| Recording mode/<br>Resolution | Frame rate          | Usage time          | BP-950G | BP-955 | BP-970G | BP-975 |
|-------------------------------|---------------------|---------------------|---------|--------|---------|--------|
| RAW / 4096x2160               | 59.94P              | Recording (maximum) | 80      | 75     | 110     | 115    |
|                               |                     | Recording (typical) | 45      | 45     | 65      | 70     |
|                               | 50.00P              | Recording (maximum) | 80      | 80     | 115     | 125    |
|                               |                     | Recording (typical) | 50      | 50     | 70      | 75     |
|                               | 25.00P              | Recording (maximum) | 90      | 90     | 125     | 135    |
|                               |                     | Recording (typical) | 55      | 55     | 75      | 80     |
|                               | 24.00P              | Recording (maximum) | 90      | 90     | 125     | 135    |
|                               |                     | Recording (typical) | 55      | 50     | 75      | 80     |
| 23.98P                        | Recording (maximum) | 90                  | 90      | 125    | 135     |        |
|                               | Recording (typical) | 50                  | 50      | 75     | 80      |        |

**Approximate times when shooting in 2K mode**

The following are the shooting times with the monitor unit attached (LCD screen and viewfinder on), output from the 3G-SDI terminals, MON. terminals and HD/SD SDI terminal on, and when simultaneously recording an MXF clip (50 Mbps, 1920x1080, 23.98P).

| Recording mode/<br>Resolution       | Frame rate | Usage time          | BP-950G | BP-955 | BP-970G | BP-975 |
|-------------------------------------|------------|---------------------|---------|--------|---------|--------|
| <b>RGB444</b> 12-bit /<br>2048x1080 | 59.94P     | Recording (maximum) | 90      | 90     | 125     | 135    |
|                                     |            | Recording (typical) | 50      | 50     | 75      | 80     |
| <b>RGB444</b> 10-bit /<br>2048x1080 | 50.00P     | Recording (maximum) | 90      | 90     | 125     | 135    |
|                                     |            | Recording (typical) | 55      | 55     | 75      | 80     |
|                                     | 24.00P     | Recording (maximum) | 90      | 90     | 125     | 135    |
|                                     |            | Recording (typical) | 55      | 55     | 75      | 80     |
| <b>YCC422</b> 10-bit /<br>2048x1080 | 59.94P     | Recording (maximum) | 85      | 85     | 120     | 130    |
|                                     |            | Recording (typical) | 50      | 50     | 70      | 75     |
|                                     | 50.00P     | Recording (maximum) | 90      | 90     | 125     | 135    |
|                                     |            | Recording (typical) | 55      | 55     | 75      | 80     |

**Approximate times for MXF mode**

The following are the shooting times with the monitor unit attached (LCD screen and viewfinder on) and output from the HD/SD SDI terminal on.

| Bit rate/Resolution    | Frame rate | Usage time          | BP-950G | BP-955 | BP-970G | BP-975 |
|------------------------|------------|---------------------|---------|--------|---------|--------|
| 50 Mbps /<br>1920x1080 | 24.00P     | Recording (maximum) | 155     | 155    | 220     | 235    |
|                        |            | Recording (typical) | 95      | 95     | 135     | 140    |

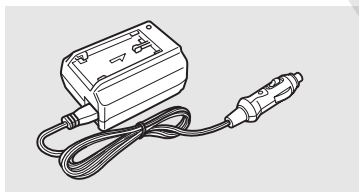

**CB-920 Car Battery Adapter**

Use the car battery adapter to charge battery packs on the go. The car battery adapter plugs into your car's cigarette lighter socket and runs off a 12-24 V DC negative ground battery.

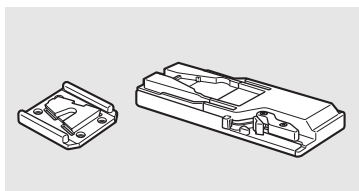

**TA-100 Tripod Adapter**

The TA-100 allows you to quickly mount/unmount the camera on/from a tripod.

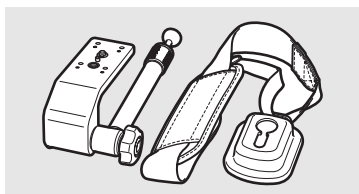

**SBR-1000 Shooting Brace**

Using the SBR-1000 for additional support of the camera with the neck strap will significantly lighten the load of the camera's weight while shooting.



This mark identifies genuine Canon video accessories. When you use Canon video equipment, we recommend Canon-brand accessories or products bearing the same mark.

# Specifications

## C500 / C500 PL

### System

- **Video Configuration for 4K and 2K Modes**

4K mode:

Mode: RAW, HRAW, 4K1K RAW (both 10-bit)

Resolution: 4096x2160, 3840x2160, 4096x1080, 3840x1080

Frame rate<sup>1</sup>: 59.94P, 29.97P, 23.98P, 50.00P, 25.00P, 24.00P

2K mode:

Mode: RGB, 4:4:4, 12-bit; RGB, 4:4:4, 10-bit; YCC, 4:2:2, 10-bit

Resolution: 2048x1080, 1920x1080

Frame rate<sup>1</sup>: 59.94P, 29.97P, 23.98P, 50.00P, 25.00P, 24.00P

<sup>1</sup> Available frame rates depend on the resolution and recording mode settings.

- **Recording System**

Movies: Video compression: MPEG-2 Long GOP;

Audio compression: Linear PCM, 16 bits, 48 kHz, 2 channels

File type: MXF

Photos: DCF (Design rule for Camera File system), compatible with Exif Ver. 2.3, JPEG compression

- **Video Configuration (MXF recording/playback)**

50 Mbps (CBR, 4:2:2, 422P@HL)

1920x1080: 59.94i, 50.00i, 29.97P, 25.00P, 24.00P, 23.98P

1280x720: 59.94P, 50.00P, 29.97P, 25.00P, 24.00P, 23.98P

35 Mbps (VBR, 4:2:0, MP@HL)

1920x1080: 59.94i, 50.00i, 29.97P, 25.00P, 23.98P

1280x720: 59.94P, 50.00P, 29.97P, 25.00P, 23.98P

25 Mbps (CBR, 4:2:0, MP@H14)

1440x1080: 59.94i, 50.00i, 29.97P, 25.00P, 23.98P

- **Recording Media (not included)**

Movies: CompactFlash (CF) Card Type I (two slots)

Photos: SD or SDHC (SD High Capacity) memory card<sup>2</sup>

<sup>2</sup> Custom picture files, camera settings and user memo files can be saved on and read from the memory card as well.

- **Maximum Recording Time (approximate, continuous recording)**

16 GB CF Card

50 Mbps: 40 min., 35 Mbps: 55 min., 25 Mbps: 80 min.

64 GB CF Card

50 Mbps: 160 min., 35 Mbps: 225 min., 25 Mbps: 310 min.

- **Image Sensor:** Super-35mm-equivalent CMOS sensor, approx. 8,850,000 effective pixels (4096x2160)

- **Viewfinder:** 1.3 cm (0.52 in.), approx. 1,555,000 dots, 100% coverage

- **Lens Mount**

**C500** Canon EF mount compatible with Canon EF lenses (including EF-S lenses)

**C500 PL** PL Lens mount without data interface terminals

Lens multiplication factor (for 35mm equivalent focal length):

Approx. 1.46 (when the horizontal resolution is 4096 or 2048)

Approx. 1.53 (when the horizontal resolution is 3840 or 1920)

- **ND Filter:** Built-in (Off, 2, 4 or 6 stops), motor operated

- **White Balance**

Custom white balance (two sets, A and B), color temperature setting (2,000K to 15,000K); two preset settings (daylight, 5,400 K and incandescent lamp, 3,200 K)<sup>3</sup> that can be further fine-tuned

<sup>3</sup> Color temperatures are approximate.

- **C500** Iris: 1/2-stop increments, 1/3-stop increments, fine-tuning
- **ISO Speed**  
 1-stop increments: ISO 320, ISO 400 to ISO 12800, ISO 20000, ISO 25000<sup>4</sup>, ISO 51200<sup>4</sup>, ISO 80000<sup>4</sup>  
 1/3-stop increments: ISO 320 to ISO 20000, ISO 25000<sup>4</sup> to ISO 80000<sup>4</sup>
- **Gain:** -6 dB to 30 dB, 33 dB<sup>4</sup> to 42 dB (3-dB increments)  
 0 dB to 24 dB, 33 dB<sup>4</sup> to 42 dB (fine-tuning in 0.5-dB increments)  
<sup>4</sup> With extended ISO/Gain range.
- **Shutter Speed**  
 Speed (1/3-stop increments, 1/4-stop increments), angle, clear scan, slow, off
- **C500 Lens Peripheral Illumination Correction:** Available for Canon EF lenses<sup>5</sup>  
<sup>5</sup> Some Canon EF lenses are not compatible with peripheral illumination correction.
- **Sensor Sensitivity (MXF mode, ISO 640 (0 dB), 2000 lux, 89.9% reflection)**  
 59.94 Hz mode: F9 (1920x1080 at 59.94i) 50.00 Hz mode: F10 (1920x1080 at 50.00i)
- **S/N Ratio (MXF mode, ISO 850, using Canon Log gamma)**  
 54 dB (typical, 1920x1080, 59.94 Hz mode at 29.97P / 50.00 Hz mode at 25.00P)
- **Subject Illumination (MXF mode, 24 dB, with a f/1.2 lens)**  
 59.94 Hz mode: 0.30 lux (29.97P, shutter speed 1/30)  
 50.00 Hz mode: 0.25 lux (25.00P, shutter speed 1/25)
- **Size of Photos**  
 1920x1080 pixels, 1280x720 pixels (only when capturing a photo from a clip)

## Terminals

- **3G-SDI Terminals 1 and 2**  
 BNC jack, output only, 0.8 Vp-p / 75 Ω, unbalanced, 2.97 Gbps  
 SMPTE 424M, SMPTE ST 425-1  
 Video: Resolution: 4096x2160, 3840x2160, 4096x1080, 3840x1080  
 Mode: RAW (10-bit), HRAW (10-bit), 4K1K RAW (10-bit),  
 RGB 4:4:4 (12-bit); RGB 4:4:4 (10-bit); YCC 4:2:2 (10-bit)  
 Frame rate<sup>1</sup>: 59.94P, 29.97P, 23.98P, 50.00P, 25.00P, 24.00P  
 Color space: BT. 709, DCI-P3+, Cinema Gamut  
 Embedded audio, time code (VITC/LTC)  
<sup>1</sup> Available frame rates depend on the resolution and recording mode settings.
- **MON. Terminals 1 and 2**  
 BNC jack, output only, 0.8 Vp-p / 75 Ω, unbalanced, 1.485 Gbps  
 SMPTE ST 292-1  
 Video: Resolution: 2048x1080, 1920x1080  
 Mode: YCC, 4:2:2, 10-bit  
 Frame rate<sup>2</sup>: 59.94i, 29.97P/PsF, 23.98P/PsF, 50.00i, 25.00P/PsF, 24.00P/PsF  
 Color space: BT. 709, DCI-P3+, Cinema Gamut  
 LUT: BT. 709, Wide DR, DCI  
 Embedded audio, time code (VITC/LTC), assistance displays<sup>3</sup> (magnification, peaking, zebra pattern, onscreen markers), ACESproxy10 output (MON. 2 terminal only)  
<sup>2</sup> Available frame rates depend on the resolution and recording mode settings.  
<sup>3</sup> Magnification is available for the output from both MON. 1 and MON. 2 terminals. Other assistance displays are available for the output from the MON. 1 terminal only.
- **HD/SD SDI Terminal**  
 BNC jack, output only, 0.8 Vp-p / 75 Ω, unbalanced, 1.485 Gbps  
 HD-SDI: SMPTE 292  
 Video: Resolution: 1920x1080, 1280x720  
 Frame rate<sup>4</sup>: 59.94i, 29.97 (P/PsF), 23.98 (P/PsF), 50.00i, 25.00 (P/PsF),  
 24.00 (P/PsF), 59.94P, 50.00P

SD-SDI: SMPTE 259M  
 Video: Resolution: 640x480, 768x576  
 Frame rate: 59.94i, 50.00i

Embedded audio, time code (VITC/LTC), LUT (BT. 709, Wide DR)

<sup>4</sup> Available frame rates depend on the resolution and recording mode settings.

- **HDMI OUT Terminal**  
HDMI connector, output only
- **SYNC OUT Terminal**  
BNC jack, output only, 1 V<sub>p-p</sub> / 75 Ω  
Output signal: HD component video luminance signal (HD-Y), HD analog tri-level signal, Analog blackburst signal, SD composite video
- **MIC Terminal**  
Ø 3.5 mm stereo mini-jack, -72 dBV (manual volume center, full scale -18 dB) / 600 Ω  
Microphone attenuator: 20 dB
- **Ⓜ (Headphone) Terminal**  
Ø 3.5 mm stereo mini-jack, -∞ to -12 dBV (16 Ω load, volume range Min to Max) / 50 Ω or less
- **GENLOCK Terminal**  
BNC jack, input only: 1 V<sub>p-p</sub> / 75 Ω
- **TIME CODE Terminal**  
BNC jack, input/output  
Input: 0.5 V<sub>p-p</sub> to 18 V<sub>p-p</sub> / 10 kΩ  
Output: 1 V<sub>p-p</sub> / 75 Ω
- **REMOTE Terminal**  
Ø 2.5 mm stereo mini-jack
- **WFT Terminal**  
Proprietary connector for the optional WFT-E6 Wireless File Transmitter
- **GRIP Terminal**  
Same as the grip unit connection terminal on the C300 / C300 PL or C100 camcorder

## Power/Others

- **Power Supply (rated)**  
7.4 V DC (battery pack), 8.4 V DC (DC IN)
- **Power consumption (For each mode, viewfinder/LCD screen normal brightness, HD/SD SDI output on. For 4K and 2K modes, MON. and 3G-SDI output on, simultaneous MXF recording at 50 Mbps.)**

|   |                                |
|---|--------------------------------|
| During 4K mode, RAW, 4096x2160:             | 59.94P: 23.9 W, 50.00P: 22.9 W |
| During 2K mode, RGB444, 2048x1080:          | 59.94P: 20.9 W, 50.00P: 20.9 W |
| During MXF mode, 50 Mbps 1920x1080, 24.00P: | 12.4 W                         |

Maximum rated power consumption: 31.0 W
- **Operating Temperature**  
0 – 40 °C (32 – 104 °F)
- **Dimensions (W x H x D)\***  
Camera unit only:  
**C500** 160 x 179 x 171 mm (6.3 x 7.0 x 6.7 in.) **C500 PL** 160 x 179 x 177 mm (6.3 x 7.0 x 7.0 in.)  
 Configuration with monitor unit:  
 185 x 249 x 187 mm (7.3 x 9.8 x 7.4 in.)  
 Configuration with handle unit and monitor unit:  
 185 x 284 x 301 mm (7.3 x 11.2 x 11.9 in.)

\* All dimensions are approximate.

• **Weight \*\***

Camera unit only:

**C500** 1820 g (4.0 lb.)      **C500PL** 1930 g (4.3 lb.)

Camera with monitor unit, BP-955 battery pack and two CF cards:

**C500** 2705 g (6.0 lb.)      **C500PL** 2815 g (6.2 lb.)

Camera with monitor unit, handle unit, BP-955 battery pack and two CF cards:

**C500** 2885 g (6.4 lb.)      **C500PL** 2995 g (6.6 lb.)

\*\*All weights are approximate.

## Modular Units

### Monitor Unit

Modular unit can be rotated 270° on its axis; includes the LCD panel, recording and playback controls, XLR terminals and related audio controls.

- **LCD Panel:** Articulated panel, 270° vertical rotation, 180° lateral rotation
- **LCD Screen:** 10.1 cm (4.0 in.), wide, color, approx. 1,230,000 dots, 100% coverage
- **CH1, CH2 Terminals**  
XLR jack (pin1: shield, pin2: hot, pin3: cold), 2 sets  
Sensitivity  
    MIC setting: -60 dBu (manual volume center, full scale -18 dB) / 600 Ω  
    LINE setting: 4 dBu (manual volume center, full scale -18 dB) / 10 kΩ  
    Microphone attenuator: 20 dB
- **Weight:** Approx. 645 g (1.4 lb.)

### Handle Unit

Modular unit includes a cold accessory shoe and socket for 0.64 cm (1/4 in.) screws for other accessories.

- **Weight:** Approx. 180 g (6.3 oz.)

### (32 – 104 °F)(4.1 x 2.0 x 5.5 in.) **CA-941 Compact Power Adapter**

- **Rated Input:** 100 – 240 V AC, 50/60 Hz, 0.65 A (100 V) – 0.36 A (240 V)
- **Rated Output:** 8.4 V DC, 3.7 A
- **Operating Temperature:** 0 – 40 °C
- **Dimensions (W x H x D):** Approx. 103 x 51 x 139 mm
- **Weight:** 480 g

### CG-940 Battery Charger

- **Rated Input:** 100 – 240 V AC, 50/60 Hz, 24 W
- **Rated Output:** 8.4 V DC, 1.5/2.0 A
- **Operating Temperature:** 0 – 40 °C (32 – 104 °F)
- **Dimensions (W x H x D):** 85 x 51 x 110 mm (3.3 x 2.0 x 4.3 in.)
- **Weight:** Approx. 240 g (8.5 oz.)

### BP-955 Battery Pack

- **Battery Type**  
Rechargeable lithium ion battery, compatible with Intelligent System
- **Rated Voltage**  
7.4 V DC
- **Operating Temperature:** 0 – 40 °C (32 – 104 °F)
- **Battery Capacity**  
Typical: 5,200 mAh  
Minimum: 37 Wh / 4,900 mAh
- **Dimensions (W x H x D):** 38.2 x 43.5 x 70.5 mm (1.5 x 1.7 x 2.8 in.)
- **Weight:** 220 g (7.8 oz)

COPY



2K mode .....60  
 3G-SDI 1/2 terminals .....41  
 4K mode .....60  
 4K1K RAW .....60

## A

ABB (automatic black balance) .....48  
 Accessories .....200  
 ACES .....22  
 ACESproxy10 .....146  
 Air vents .....32  
 Aperture\* .....74  
 Aspect ratio .....145, 148  
 Assignable buttons .....111  
 Audio peak limiter .....94, 95  
 Audio recording .....92  
 Audio recording level .....94, 95  
 Audio reference signal .....99

## B

Battery pack .....23  
 Bit rate .....60  
 Black balance .....48  
 Built-in backup battery .....196

## C

C. Gamut .....142  
 Camera settings .....124  
 Canon Log gamma .....58  
 CF card  
     Inserting .....43  
     Recording method .....46  
     Recovering data .....47  
     Removing .....44  
     Switching CF card slots .....46, 126  
 Check marks (☑) .....103, 132  
 CINEMA (preset custom picture) .....58  
 Cinema Gamut .....142  
 Clips, MXF  
     Adding an ☑ mark/☑ mark .....103, 132  
     Adding/Deleting shot marks .....102, 136  
     Copying .....133  
     Deleting .....134  
     Displaying clip information .....131  
     Playback .....126  
 Color bars .....99

Color space .....142  
 Condensation .....198  
 Connection to an external monitor .....144  
 Connection to an external recorder .....41  
 Cooling fan .....59  
 Custom displays .....123  
 Custom functions .....122  
 Custom picture .....114  
 Custom picture settings .....117

## D

Date and time .....27  
 Date format .....177  
 DC IN terminal .....25  
 DCI gamma .....146  
 DCI-P3+ .....142  
 Developing RAW clips .....150  
 Direct setting mode .....66  
 Double slot recording .....46  
 Drop frame (time code) .....85

## E

Edge monitor .....101  
 EF lens mount\* .....32  
 EXT 1/2 terminals .....35  
 External recorder .....41  
 Eye cup .....36

## F

Focus-related functions .....79  
 Frame rate .....60  
 Frame recording mode .....106  
 Free-run (time code) .....84

## G

Gain .....70  
 GENLOCK terminal .....88

## H

Handle unit .....39  
 HD/SD SDI terminal .....147  
 HDMI OUT terminal .....147  
 Headphone terminal .....96  
 Hour meter .....179  
 HRAW .....60

|                                     |          |
|-------------------------------------|----------|
| <b>I</b>                            |          |
| Index screens                       |          |
| Changing clip thumbnail             | 137      |
| Clips                               | 125      |
| Expand clip                         | 136      |
| Shot marks                          | 135      |
| Initializing recording media        | 45       |
| Interval recording mode             | 105      |
| Iris*                               | 74       |
| ISO speed                           | 70       |
| <b>J</b>                            |          |
| Joystick                            | 29       |
| Joystick guide                      | 128      |
| <b>K</b>                            |          |
| Key lock                            | 53       |
| <b>L</b>                            |          |
| Language                            | 28       |
| LCD screen                          | 38       |
| Lens                                | 32       |
| Lens exchange mode                  | 34       |
| LUT (lookup table)                  | 146      |
| <b>M</b>                            |          |
| Magnification                       | 80       |
| Menu settings                       | 169      |
| Message list                        | 190      |
| Metadata                            | 97       |
| MIC terminal                        | 92       |
| Microphone                          | 92       |
| Microphone attenuator               | 95, 96   |
| Microphone sensitivity              | 95       |
| MON. 1/2 terminals                  | 41       |
| Monitor unit                        | 35       |
| MXF mode                            | 64       |
| My Menu                             | 30       |
| <b>N</b>                            |          |
| ND filter                           | 73       |
| Non-drop frame (time code)          | 85       |
| <b>O</b>                            |          |
| OK marks (OK)                       | 103, 132 |
| Onscreen markers                    | 82       |
| On-set color grading                | 22, 146  |
| <b>P</b>                            |          |
| Peaking                             | 80       |
| Peripheral illumination correction* | 34       |
| Phantom power (microphone)          | 93       |
| Photos                              |          |
| Copying custom picture files        | 166      |
| Deleting                            | 164      |
| Protecting                          | 165      |
| Viewing                             | 163      |
| PL lens mount**                     | 35       |
| Playback                            |          |
| Clips                               | 126      |
| Photos                              | 163      |
| Power supply                        | 23       |
| POWER switch                        | 26       |
| Pre-recording mode                  | 110      |
| <b>R</b>                            |          |
| RAW                                 | 60       |
| Rear panel                          | 57       |
| Rec run (time code)                 | 84       |
| Recording                           |          |
| Clips                               | 51       |
| Photos                              | 161      |
| Recording mode                      | 60       |
| Relay recording                     | 46       |
| Remaining battery                   | 24       |
| Remote operation                    | 49       |
| Resetting all camera settings       | 177      |
| Resolution (frame size)             | 60       |
| Reviewing an MXF clip               | 104      |
| RGB, 4:4:4 (RGB444)                 | 60       |
| Running mode (time code)            | 84       |
| <b>S</b>                            |          |
| Safety zone                         | 82       |
| Saving MXF clips to a computer      | 153      |
| SD card                             | 44       |
| Shooting frame rate                 | 108      |
| Shot marks                          | 102, 136 |
| Shutter speed                       | 67       |
| Slow & fast motion recording mode   | 108      |
| Specifications                      | 203      |

|                         |          |
|-------------------------|----------|
| Status screens .....    | 180      |
| SYNC OUT terminal ..... | .90, 148 |
| Synchronization .....   | .88      |
| System frequency .....  | .64      |
| System priority .....   | .60, 64  |

**T**

|                                 |         |
|---------------------------------|---------|
| Tally lamp .....                | .177    |
| Terminal covers .....           | .40     |
| Time code .....                 | .84     |
| TIME CODE terminal .....        | .89, 91 |
| Tripod .....                    | .38     |
| Troubleshooting .....           | .187    |
| Turning the camera on/off ..... | .26     |

**U**

|                 |     |
|-----------------|-----|
| User bit .....  | .87 |
| User memo ..... | .97 |

**V**

|                                  |      |
|----------------------------------|------|
| Vectorscope .....                | .101 |
| Video configuration .....        | .60  |
| Video output configuration ..... | .139 |
| View assistance .....            | .58  |
| Viewfinder .....                 | .38  |

**W**

|                        |     |
|------------------------|-----|
| Waveform monitor ..... | 100 |
| WFT terminal .....     | 49  |
| White balance .....    | 76  |
| Wide DR .....          | 171 |
| Wi-Fi Remote .....     | 49  |

**X**

|                     |    |
|---------------------|----|
| XLR terminals ..... | 92 |
|---------------------|----|

**Y**

|                           |    |
|---------------------------|----|
| YCC, 4:2:2 (YCC422) ..... | 60 |
|---------------------------|----|

**Z**

|                     |    |
|---------------------|----|
| Zebra pattern ..... | 83 |
|---------------------|----|



Canon Inc. 30-2, Shimomaruko 3-chome, Ohta-ku, Tokyo 146-8501, Japan

---

**ASIA and HONG KONG, S.A.R.**

Canon Hongkong Company Ltd  
19/F, The Metropolis Tower, 10 Metropolis Drive,  
Hungghom, Kowloon, Hong Kong  
☎ +852 3191 2333, 📠 +852 2428 3963

**AUSTRALIA** [www.canon.com.au](http://www.canon.com.au)

Canon Australia Pty Ltd  
☎ 13-13-83 (within Australia only)  
☎ (61) 02-9805-2555

**CANADA**

CANON CANADA INC.  
<http://www.canon.ca/pro>  
❖ Professional Product Support / Soutien des  
produits professionnels  
☎ (800) 667-2666

**CENTRO Y SURAMÉRICA**

CANON LATIN AMERICA, INC.  
<http://www.cla.canon.com>

**EUROPE** [www.canon-europe.com](http://www.canon-europe.com)

Canon Europa N.V.  
Bovenkerkerweg 59,  
1185 XB Amstelveen, The Netherlands

**MÉXICO**

CANON MEXICANA, S DE RL DE CV  
<http://www.canon.com.mx>  
☎ 52 (55) 5249-4905

**NEW ZEALAND** [www.canon.co.nz](http://www.canon.co.nz)

Canon New Zealand Ltd  
☎ 0800-222-666 (within New Zealand only)  
☎ (64) 09-489-0300

**SINGAPORE**

Canon Singapore Pte. Ltd  
1 HarbourFront Avenue, #04-01 Keppel Bay Tower,  
Singapore 098632  
☎ (65) 6799 8888, 📠 (65) 6799 8882

**UNITED KINGDOM**

Canon UK Ltd  
CCI Service Centre, Unit 130, Centennial Park,  
Borehamwood, Hertfordshire, WD6 3SE  
☎ 0844-369-0100

**USA**

CANON U.S.A., INC.  
<http://pro.usa.canon.com>  
<http://pro.usa.canon.com/support>  
☎ (855) CINE-EOS (855-246-3367)  
(USA only)

---

Visit your local Canon Web site to download the latest version of this Instruction Manual.

